

# HCS2 1201-30

## ■ OPTIONS

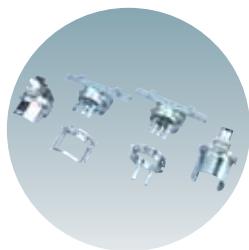

Laser Position Marker



Cap Frame Kit

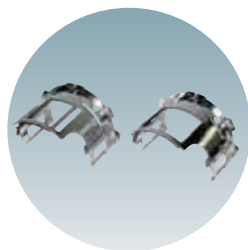

One Point Frame



Sock Frame

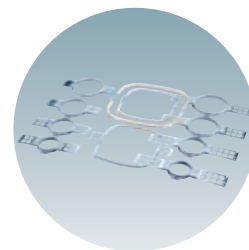

Various Frames

## ■ STANDARD FEATURES AND FUNCTION

- Color LCD Touch Screen Control Panel
- HAPPY Link/LAN Software
- Automatic Color Change
- Automatic Thread Brake Detection
- USB/LAN Port for PC Connection
- USB Port for Flash Drive/Mouse
- Built-in Bobbin Thread Winder
- Frame Trace Function
- Frame Offset Function
- Frame Out Function
- Auto Origin Function
- Built-in Help Function
- Design Convert
- Design Rotate
- Repeat Sewing
- Automatic Short Stitch Removal
- Icon Free Positioning
- Multilingual Operation

## ■ SPECIFICATIONS

MODEL	Head	Needles	Embroidery Area (DxW)			Maximum Speed (r.p.m.)	Stitch Length	Memory
			Maximum	Wide Cap Frame	Low-profile Cap frame			
HCS2-1201-30	1	12	285×290mm 11.2×11.4inch	67×290mm 2.6×11.4inch	67×180mm 2.6×7.1inch	1,000 750(cap)	0.1-12.7mm	40,000,000 stitches 250 patterns

MODEL	Power Supply	Power Consumption	Frequency	Weight	Dimensions						
					L	W	H	A	B	C	
HCS2-1201-30	Single Phase 100-115V 200-230V	220W	50/60Hz	42kg 93lbs	642	745	734	250	480	580	(mm)
					25.3	29.3	28.9	9.8	18.9	22.8	(inch)

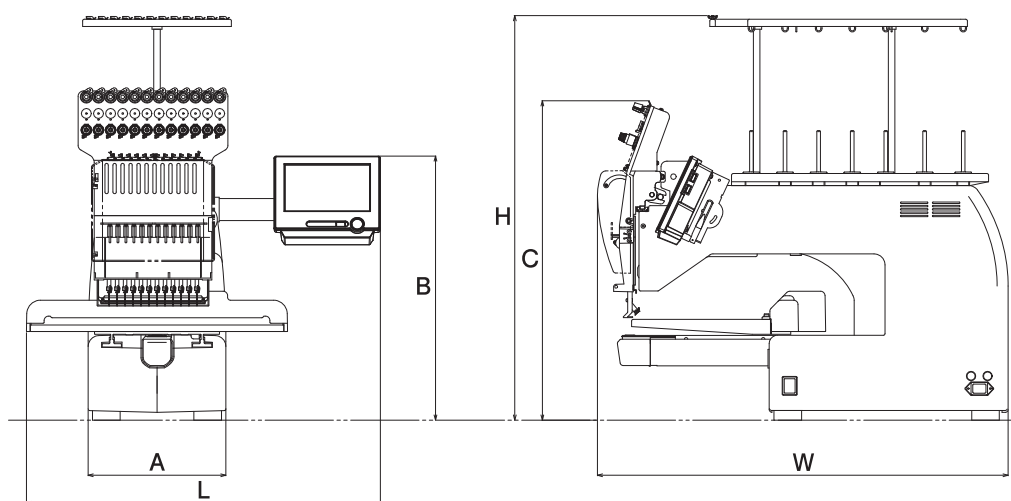

### NOTE

- Embroidery area may be limited by hoops to be used.
- Specifications are subject to change without notice.
- Maximum speed may change by sewing conditions.

Manufactured by :

HAPPY Industrial Corporation

TOKYO OFFICE: 2-9-5 TAITO, TAITO-KU, TOKYO, 110-0016 JAPAN

phone: +81-3-3834-0711 fax: +81-3-3835-8917

E-mail: emb-info@happy-ind.co.jp

www.happy-ind.co.jp

Distributed by :

# HCS2 1201-30

Computerized Compact Embroidery Machine

**ULTIMATE EMBROIDERY MACHINE**

ULTRA LIGHT / ULTRA COMPACT

ULTRA FAST / ULTRA EASY OPERATION

HAPPY Industrial Corporation

JAPAN

# ULTIMATE EMBROIDERY MACHINE "HCS2 1201-30"

COMPACT!  
FAST!  
EASY OPERATE!  
LIGHT WEIGHT!

HCS series that has good reputation, is renewed as HCS2 series equipped with color LCD touch screen control panel. The touch screen control panel makes operation easier, enabling you to quickly master the operation even for beginners.

## Color LCD Touch Screen Control Panel

Newly designed color LCD touch screen control panel makes operation easier and faster. A stylus is equipped as standard, and USB mouse for PC can be used.



## Happy Link & LAN Connection

USB connection with machine and PC with Link software enables you to transfer and control designs and change color and set sewing. LAN system enables network to control multiple machines with one PC. Monogramming and design editing functions expand the flexibilities and the possibilities.

Example of editing function

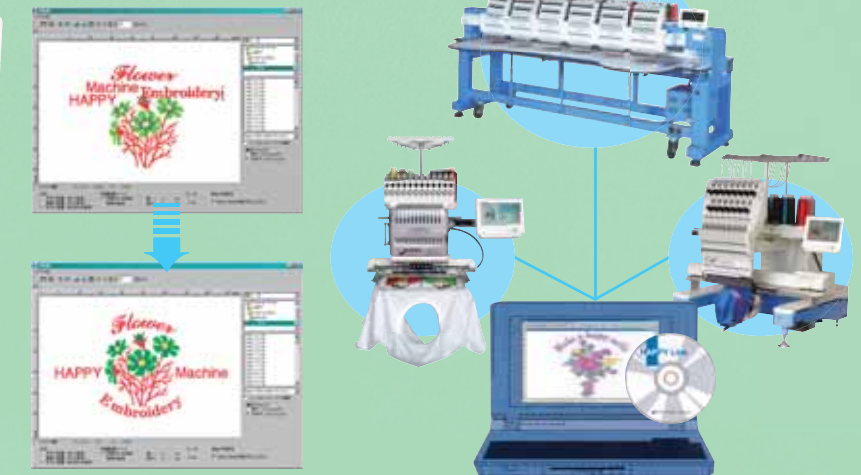

### SAFETY COVER

If the cover is opened during operating, a sensor detects it is opening and the machine automatically stops to avoid danger.



### NARROW CYLINDER ARM

Happy's narrow cylinder arm allows embroidery in tight areas, such as cuffs or pockets. The small diameter of the arm fits in areas normal machine's can not sew.

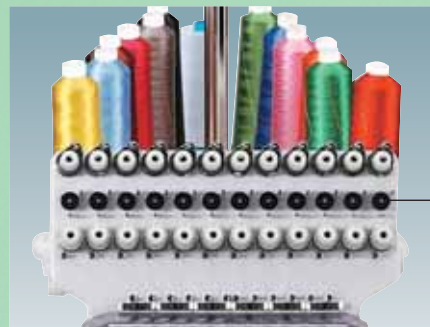

### ROTARY THREAD BRAKE DETECTING SENSOR

The rotary thread break sensor monitors each thread and automatically stops machine when the thread has broken or the bobbin is empty.



### THREAD ADJUSTING SPRING

Happy's thread adjusting spring provides smooth upper thread supply and high quality embroidery even at high speed.



### BUILT IN BOBBIN WINDER

The machine is equipped with a bobbin winding device. (Independent bobbin winding motor system)



### FRONT LIGHT

A bright LED light illuminates the work area bright.



# HCS2 1201-30

Computerized Compact Embroidery Machine Made in Japan

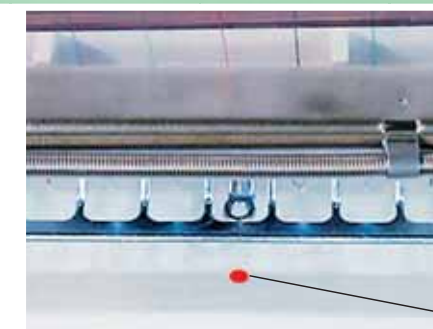

### LASER POSITION MARKER (OPTION)

Needle hole position is shown accurately.



### CAP FRAME (OPTION)

LOW-PROFILE CAP FRAME  
WIDE CAP FRAME