

Form 8360
October, 1916
Printed in U. S. A.

LIST OF PARTS



MACHINE No. 82-20

** A TRADE MARK OF

THE SINGER MANUFACTURING COMPANY

INSTRUCTIONS FOR OILING

To ensure easy running and prevent unnecessary wear of the parts which are in movable contact, the machine requires oiling and when in continuous use, "TYPE B" or "TYPE D" OIL, sold only by Singer Sewing Machine Company, should be applied at least twice each day to all oil holes marked "OIL".

"TYPE D" OIL is stainless.

INDEX

	PAGE
ACCESSORIES.....	12
CABINET TRIMMINGS FOR STAND.....	15
IRON BASE.....	12
KNEE LIFTER PARTS.....	12
MACHINE NO. 82-20.....	7
NUMERICAL LIST OF PARTS.....	19
OBSOLETE PARTS.....	18
THREAD UNWINDER.....	16
STAND (HIGH SPEED).....	14
" (ROCKING TREADLE).....	13
UNDER DRIVERS.....	16-18

INSTRUCTIONS FOR ORDERING

In ordering from this list, use **ONLY** the part **NUMBER** in the **FIRST** column.

The number stamped on a Sewing Machine part is in every case the number of the single part only.

Every combination of parts sent out as such has its specific number, which, although not stamped on the parts, must be used when ordering the combination.

Each number always indicates the **SAME PART** in whatever list it appears, or for whatever machine.

The letters after some of the numbers indicate the style of finish only, as follows:

- A. Hardened, Polished and Plated.
- B. Polished and Plated.
- C. Hardened only.
- D. Polished only.
- E. Soft, not Polished.
- F. Hardened and Polished.
- G.
- H. Blued.
- J. Plated only.
- K. Hardened and Plated.
- L. Brass or Gilt.
- M. Oxidized.
- P. Japanned.

These letters **MUST BE USED** when they appear in the list, and **AFTER** the number as in the list.

In this series

- 1 to 1500 and 50001 to 51500 are Screw Numbers.
- 1501 to 1800 are Nut Numbers.
- 1801 to 2000 are Roller Numbers.
- 2001 to 50000 and 52001 and upward are numbers of Machine Parts.

The figures in the second column refer only to the plates, illustrating the parts, and are **NOT TO BE USED** in ordering.

Parts marked with an asterisk (*) are furnished only when repairs are made at factory.

When ordering parts which differ as to **GAUGE** (the distance between seams) the **GAUGE** as well as the **NUMBER** **MUST BE GIVEN** on order.

LIST OF PARTS COMPLETE FOR MACHINE NO. 82-20

**FOR ORNAMENTING THE BACKS OF GLOVES MADE FROM TRICOT, MILANESE, ETC., WITH TWO LINE CHAIN EMBROIDERY, ALSO FOR PARIS POINTING, INSERTING GLOVE THUMBS AND SILK-ING THE BACKS OF LIGHT WEIGHT LEATHER GLOVES.
TWO NEEDLES, TWO LOOPERS.**

NO.	PLATE	NAME
*57042	----	Arm, upper and lower (solid) with 130b, 9830, 42685, 42697 and two each 462c, 1259c and 42602.....
42599	5133	Arm Rock Shaft.....
42600	5134	“ “ “ Crank (back) with two 1259c.....
1259c	5134	Arm Rock Shaft Crank (back) Position Screw.....
1259c	5134	Arm Rock Shaft Crank (back) Set Screw.
42601	5134	“ “ “ “ (front) with two 1259c.....
1259c	5134	Arm Rock Shaft Crank (front) Position Screw.....
1259c	5134	Arm Rock Shaft Crank (front) Set Screw.
42602	5134	“ “ “ Flanged Bushing (back)
1259c	5134	“ “ “ “ “ “ “ Set Screw.....
42602	5134	Arm Rock Shaft Flanged Bushing (front)
1259c	5134	“ “ “ “ “ “ “ Set Screw.....
57016	5133	Arm Rotary Shaft.....
199d	5137	“ “ “ Screw.....
32026	5133	Balance Wheel.....
42680	5138	Cloth Plate (narrow).....
57017	5138	“ “ (wide).....
387F	5137	“ “ Screw.....
57098	5134	Connecting Rod with 34434 and two 171E
*34434	----	“ “ Cap.....
171E	5134	“ “ “ Screw.....
378c	5134	“ “ “ Hinge Screw.....
1520E	5134	“ “ “ “ Nut.....
42681	5139	Face Plate with 8505 and 42682.....
50318d	5137	“ “ Screw.....
42682	5139	“ “ Thread Eyelet (double).....
8505	5137	“ “ “ “ Rivet. per 100

NO.	PLATE	NAME
42613	5134	Feed Bar.....
42614	5134	" " Hinge Stud.....
1147C	5135	" " " " Set Screw.....
42615	5134	" " Slide Block.....
42507	5135	" Connecting Rod with 38588 and two 1057E.....
*38588	---	Feed Connecting Rod Cap.....
1057E	5135	" " " " Screw.....
57022	5143	" Dog, for $\frac{1}{8}$ in. gauge, for inserting glove thumbs.....
57027	5143	Feed Dog, for $\frac{1}{8}$ in. gauge, for silking the backs of light weight leather gloves....
57031	5144	Feed Dog, for $\frac{1}{8}$ in. gauge, for stitching around air tucks on backs of leather gloves.....
42683	5144	Feed Dog, for $\frac{5}{64}$ in. to $\frac{1}{8}$ in. gauge, for two line chain embroidery.....
57010	5145	Feed Dog, for $\frac{5}{64}$ in. to $\frac{1}{8}$ in. gauge, for Paris pointing.....
57082	5145	Feed Dog, for $\frac{3}{32}$ in. to $\frac{1}{8}$ in. gauge, for inserting glove thumbs.....
57034	5146	Feed Dog, for $\frac{9}{64}$ in. to $\frac{7}{32}$ in. gauge, for two line chain embroidery.....
57092	5146	Feed Dog, for $\frac{3}{16}$ in. gauge, for two or three rows of stitching and two line embroidery.....
190D	5137	Feed Dog Screw.....
42684	5135	" Eccentric with two 1259C.....
1259C	5134	" " Position Screw.....
1259C	5134	" " Set Screw.....
42670	5135	" Regulator with 157D and 233D.....
1038C	5135	" " Adjusting Screw.....
7070	5135	" " " " Sleeve..
1589C	5135	" " " " Thumb Nut.....
157D	5135	Feed Regulator Clamping Screw.....
233D	5135	" " Stop Screw.....
42618	5134	" Rock Shaft.....
42685	5140	" " " Bracket.....
130D	5137	" " " " Screw.....
21509	5134	" " " Collar with 207F.....
207F	5134	" " " " Set Screw.....
42620	5135	" " " Crank with 157D and 1147C.....
157D	5135	Feed Rock Shaft Crank Clamping Screw.....
42686	5139	Looper (left hand) for $\frac{1}{16}$ in. to $\frac{1}{4}$ in. gauge.....

NO.	PLATE	NAME
853C	5139	Looper (left hand) Set Screw.....
42687	5139	" (right hand) for $\frac{1}{8}$ in. gauge and above and (left hand) for $\frac{1}{8}$ in. gauge and above.....
853C	5139	Looper (right hand) Set Screw.....
42622	5139	" Cam (double) with two 1036C....
1036C	5139	" " Set Screw.....
42688	5139	" Carrier with 209H and two 853C..
209H	5139	" " Set Screw.....
42689	5139	" " Shaft.....
42690	5140	" " " Bracket with 209F..
141E	5137	" " " " Screw.....
42691	5135	" " " Bushing.....
209F	5139	" " " " Set Screw..
42692	5135	" " " Crank with 197D....
197D	5135	" " " " Clamping Screw.....
42693	5139	Looper Carrier Shaft Crank Connecting Link.....
42694	5136	Looper Driving Shaft.....
19009	5136	" " " Collar with two 454C.....
454C	5136	Looper Driving Shaft Collar Set Screw...
42695	5139	" " " Crank (left) with 1057E.....
1057E	5135	Looper Driving Shaft Crank (left) Clamping Screw.....
42631	5139	Looper Driving Shaft Crank (right, forked) with 157D and 18154.....
157D	5135	Looper Driving Shaft Crank (right, forked) Clamping Screw.....
18154	5139	Looper Driving Shaft Crank Oil Pad (felt)
54648	5136	" " " Oil Pad (braided cotton).....
57087	5141	Needle Bar with 57091, for $\frac{1}{16}$ in. gauge..
42696	5141	" " " 2273, for $\frac{5}{64}$ in. to $\frac{1}{8}$ in. gauge.....
57035	5141	Needle Bar, for $\frac{9}{64}$ in. to $\frac{3}{32}$ in. gauge....
42697	5141	" " Bushing (lower).....
462C	5135	" " " " Set Screw....
9830	5135	" " " (upper).....
462C	5135	" " " " Set Screw...
34170	5135	" " Connecting Link with two 1313E.....
1313E	5135	Needle Bar Connecting Link Adjusting Screw.....

NO.	PLATE	NAME
50026c	5135	Needle Bar Connecting Link Screw Stud
1520E	5134	" " " " " "
		Nut.....
9570	5135	Needle Bar Connecting Stud with 207E
207E	5134	" " " " Clamping Screw.....
57088	—	Needle Clamp Body.....
57089	5141	Needle Clamp complete, for $\frac{1}{16}$ in. gauge, for 57087, Nos. 195F, 1380b, 57088 and 57090.....
42698	5141	Needle Clamp with 1072F, for $\frac{3}{4}$ in. and $\frac{3}{2}$ in. gauges, for 42696.....
57014	5141	Needle Clamp with 1072F, for $\frac{7}{4}$ in. and $\frac{1}{8}$ in. gauges, for 42696.....
57036	5141	Needle Clamp with two 1072F, for $\frac{3}{4}$ in. to $\frac{1}{2}$ in. gauge, for 57035.....
234D	5141	Needle Clamp Screw for 57036.....
195F	5141	" " " " 57089.....
57090	5141	" Retaining Spring.....
1380b	5141	" " " Screw.....
1072F	5141	" Set Screw.....
2273	5141	" Stop Pin for 42696.....
57091	5141	" " " " 57087.....
34103	5136	Presser Bar.....
38540	5136	" " Lifter.....
85E	5136	" " " Screw.....
42699	5141	" " Lifting Bracket with 1133c.....
42632	5141	" " " " Guide.....
185H	5137	" " " " " Screw.....
1133c	5141	" " " " Set Screw.....
9534	5142	" " Spring.....
22405	5136	" " Washer.....
57025	5147	" Foot for 57022.....
57086	5147	" " " 57027.....
57032	5147	" " " 57031.....
57018	—	" " with 9311.....
57019	5147	" " Toe.....
9311	5147	" " " Rivet..... per 100
57020	5147	" " " Spring.....
707D	5147	" " " " Screw.....
9311	5147	" " " " Steady Pin, per 100.....
57021	5147	Presser Foot complete for 42683, Nos. 707D, 57018 to 57020 and two 9311.....
57011	5147	Presser Foot, grooved on bottom, for silk mitts, for 57010.....

NO.	PLATE	NAME
57012	5147	Presser Foot, grooved on bottom, for Paris points, for 57010.....
57083	5147	Presser Foot for 57082.....
57037	5147	" " " 57034.....
57093	—	" Foot.....
57094	5147	" " Toe.....
9311	5147	" " " Rivet..... per 100
57095	5147	" " " Spring.....
242b	5147	" " " Screw.....
57096	5147	Presser Foot complete for 57092, Nos. 242b, 57093 to 57095 and two 9311.....
185H	5137	Presser Foot Screw.....
1124D	5136	Pressure Regulating Thumb Screw.....
32027	5133	Pulley, $2\frac{1}{4}$ in. diam.....
1167D	5137	" Screw.....
2102	5136	Tension Disc.....
1560c	5136	" Regulating Thumb Nut.....
916c	5142	" Screw Stud.....
13710	5142	" Spring.....
57076	5136	" Thread Guide (double).....
17547	5136	" " " (single).....
57004	5137	Thread Controller Plate with 34224 and two 8505.....
934D	5137	Thread Controller Plate Screw.....
34224	5137	" " Spring.....
8505	5137	" " " Rivet..... per 100
57077	5137	" Eyelet (side of arm).....
193F	5137	" " Adjusting Screw.....
193F	5137	" " Screw.....
57043	5137	" Nipper Cam with 50150c.....
50150c	5137	" " " Set Screw.....
57044	5137	" " Spring.....
57045	5137	" " " Plate.....
217F	5137	" " " " Screw.....
111D	5137	" " " Screw.....
57046	5137	" " Stud.....
1137E	5137	" " Thread Guide Screw Stud.....
57006	5142	" Take-up with 460c.....
460c	5142	" " Set Screw.....
57026	5143	Throat Plate for 57022.....
57029	5143	" " " 57027.....
57033	5144	" " " 57031.....
57007	5144	" " (grooved) for 42683.....
57013	5145	" " (flush) for 57010.....
57084	5145	" " for 57082.....
57038	5146	" " (grooved) for 57034.....
57097	5146	" " for 57092.....
1230F	5142	" " Screw.....

IRON BASE

NO.	PLATE	NAME
57008	6929	Machine Base with three wood screws 1¼ in. No. 12 and four each 935D and 42088.
42088	6932	Machine Cushion (felt)
935D	6932	" " Screw

ACCESSORIES

NO.	PLATE	NAME
1408J	6931	Machine Thumb Screw, for 2 in. table
14063	6932	" " " Spring
9842	6932	" " " Washer
—	—	" Base Wood Screw 1¼ in. No. 12, for power table
36569	6930	Oiler with 36571
36570	—	" 36569, filled with oil
36571	6930	" Spout, 1¼ in. long, with 36807
36807	6932	" " Washer (leather)
26026	6930	Screw Driver (large)
26485	6930	" " (small)
35143	6930	Tweezers, 4 in.
8908	6930	Wrench for 1520

KNEE LIFTER PARTS

NO.	PLATE	NAME
14224	—	Chain, length 10 ¼ in.
42658	5140	Lifting Lever
21D	5137	" " Hinge Screw
19081	6932	" " Spring
1002C	5142	" " Stop Screw
7124	6929	Rock Shaft
2764	6929	" " Hanger (back) with two wood screws 1 in. No. 10
16128	6929	Rock Shaft Hanger (front) with two wood screws 1 in. No. 10
16646	6929	Rock Shaft Knee Arm
16647	—	Rock Shaft Knee Arm complete, Nos. 2766, 2767 and 16646
2766	6929	Rock Shaft Knee Arm Hub with 356c
356c	3817	" " " " " Set Screw
2767	6929	" " " Plate with 356c
356c	3817	" " " " " Set Screw

NO.	PLATE	NAME
6337	6929	Rock Shaft Lifting Bracket with two 356c
6338	6929	" " " " " Hook
356c	3817	" " " " " " Set Screw
356c	3817	Rock Shaft Lifting Bracket Set Screw
2770	6929	" " Stop Dog with 356c
356c	3817	" " " " " Set Screw
16129	6929	Rock Shaft complete, Nos. 2764, 6337, 6338, 7124, 16128, 16647 and two 2770.
42659	—	Knee Lifter complete (power table) Nos. 21D, 1002c, 14224, 16129, 19081 and 42658

STAND

ROCKING TREADLE, BALL BEARING PITMAN, COVER SET

NO.	PLATE	NAME
46536	2187	Band Wheel, 13 in. diam., with 972c
25055	6932	" " Brake Ball (rubber)
28270	2187	" " Crank
46535	—	Band Wheel Crank and Pitman (ball bearing) complete, Nos. 1520E, 1670E, 25361, 25371, 28270, 46506 to 46509, 46517 and eleven 25362
297c	3826	Band Wheel Crank Screw Centre
1507E	3826	" " " " " Nut
972c	3826	" " Set Screw
46545	—	Belt, size ¾ in., length 54½ in., with 25028
25028	3817	Belt Hook
25385	2187	Brace with three each 297c and 1507E
748E	3826	" Screw
25053	2187	Dress Guard
504E	5137	" " Bolt with 1510E
1510E	3817	" " " Nut
25386	2187	Leg with two each 25068 and 25069
25068	6930	" Roller
25069	6930	" " Pin
25362	3826	Pitman Ball, size 1⅝ in. per 100
46506	3826	" " Bearing Adjusting Screw Ring
46507	3826	Pitman Ball Bearing Adjusting Screw Ring Locking Washer (brass) per 100
46508	3826	Pitman Ball Bearing Ring
46509	3826	" " Case

STAND

NO.	PLATE	NAME
46517	2187	Pitman Rod with 25360.....
*25360		" " Ball.....
25371	3826	" " " Bushing.....
25361	3826	" " " Screw Bearing.....
1670E	3826	" " " " Nut.....
1520E	3826	" " Lock Nut.....
46518	2187	Treadle.....
297C	3826	" Screw Centre.....
1507E	3826	" " " Nut.....
25086	2187	Wrench for 1507, 1510 and 1670.....
25200	2187	" " 972.....
25269	----	Stand (iron work) complete, Nos. 504E, 25053, 25055, 25086, 25200, 25385, 46518, 46535, 46536, two 25386 and four 748E.....

STAND**HIGH SPEED**

NO.	PLATE	NAME
25329	3813	Band Wheel, 16 in. diam., with 1312c....
1312C	3817	" " Set Screw.....
25447	3818	" " Shaft.....
25426	3815	" " " Driver (left).....
25427	3815	" " " " Clutch (left).....
25428	3815	Band Wheel Shaft Driver (left) Clutch (right) with 5564.....
25425	3817	Band Wheel Shaft Driver (left) Clutch Spring.....
5564	3817	Band Wheel Shaft Driver (left) Clutch Spring Hook.....
25422	3815	Band Wheel Shaft Driver (right).....
25423	3815	" " " " Clutch (left).....
25424	3815	Band Wheel Shaft Driver (right) Clutch (right) with 5564.....
25425	3817	Band Wheel Shaft Driver (right) Clutch Spring.....
5564	3817	Band Wheel Shaft Driver (right) Clutch Spring Hook.....
25429	3815	Band Wheel Shaft Driving Flange with 356c.....
356c	3817	Band Wheel Shaft Driving Flange Set Screw.....
46544	----	Belt, size $\frac{5}{2}$ in., length 58 $\frac{1}{2}$ in., with 25028.....

STAND

NO.	PLATE	NAME
25028	3817	Belt Hook.....
25448	3818	Brace.....
748E	3817	" Screw.....
25431	3813	Driving Arm (left) with 435c and 25435..
25432	3813	" " (right) with 435c and 25435.
25433	3816	" " Hinge Pin.....
435c	3817	" " " " Set Screw.....
25434	3815	" Pinion.....
25451	3813	" Segment (rack).....
534E	3817	" " Bolt with 1510E.....
1510E	3817	" " " Nut.....
25446	3817	" " " " Washer.....
25349	3813	Foot Rest.....
25350	3817	" " Cotter Pin.....
25435	3816	" " Hinge Pin.....
25436	3813	Leg (left).....
25437	3813	" (right).....
25449	3818	" Stay Rod.....
1508E	3817	" " " Nut.....
25086	3813	Wrench for 1510.....
25258	----	Stand (iron work) complete, Nos. 25086, 25329, 25422 to 25424, 25426 to 25428, 25431, 25432, 25436, 25437, 25447 to 25449, two each 25349, 25350, 25425, 25429, 25433, 25434, 25451 and four each 534E, 748E, 1508E and 25446.....

CABINET TRIMMINGS FOR STAND

NO.	PLATE	NAME
28013	6930	Belt Hole Bushing (round, brass).....
28079	6930	End Leaf Hinge.....
25168	6929	" " Support Bracket.....
25150	6929	" " " Lever.....
25143	6932	" " " " Hinge Pin.....
25162	6929	End Leaf Support complete, Nos. 25143, 25150, 25168 and two wood screws $\frac{5}{8}$ in. No. 7.....
50314J	6931	Machine Thumb Screw.....
14063	6932	" " " Spring.....
9842	6932	" " " Washer.....

THREAD UNWINDER

FOR TWO SMALL SPOOLS

NO.	PLATE	NAME
27702	6932	Spool Pin
27450	6929	" Rest with 145F and two 27702.....
	145F	" " Set Screw
41547	—	Spool Weight complete, Nos. 10243 and 41546.....
41546	6932	Spool Weight Centre Pin.....
10243	6932	" " " " Washer
41541	6930	" " Thread Guide with 41542..
41542	6932	" " " " Centre Pin..
27451	6929	Stand.....
27453	6929	Thread Eyelet Rod.....
27446	6929	" " Wire (left).....
27452	6929	" " " (right).....
27454	—	Thread Eyelet complete, Nos. 27446, 27452 and 27453.....
41831	6929	Thread Unwinder complete, Nos. 27450, 27451, 27454, two each 41541, 41547 and three wood screws 1 in. No. 10.....

UNDER DRIVER

LEVER PRESSURE (RIGHT HAND) TWO SPEED

NO.	PLATE	NAME
27593	6930	Brake (fibre).....
27594	1164	" Bracket with 27593 and two 327E.....
	927C	" " Adjusting Screw.....
	1513E	" " " " Nut.....
	307C	" " Screw Centre.....
	1513E	" " " " Nut.....
	327E	" Screw.....
27595	1164	Cone Pulley (grooved) two speed, 4½ in. and 5½ in. diam., with 27473.....
27473	2186	Cone Pulley Centre Bearing.....
27888	6929	Dress Guard (right hand).....
	354c	" " Screw.....
	2018	" " " Washer.....
27597	1164	Driving Pulley (grooved) 6¼ in. diam., with 433c, 27598 and two 7958.....

NO.	PLATE	NAME
27598	—	Driving Pulley Friction Ring (leather)...
7958	2186	" " " " Stop Pin...
27631	2186	" " Hollow Stud with 27600..
27600	2186	" " " " Position Stud
	356c	" " " " Set Screw...
27632	—	" " " " Wick.....
27633	—	" " " " " Wire with 27632.....
	433c	Driving Pulley Screw Centre Bearing
	7958	" " " " " " Dowel Pin.....
27601	1164	Frame.....
27605	1164	Lever.....
27606	2186	" Centre Plug (wood).....
	427E	" " " Adjusting Screw.....
	1508E	" " " " " Nut..
	307c	" Screw Centre.....
	1513E	" " " Nut.....
27607	6930	" Spring.....
27070	1165	Shaft Driving Pulley (sectional, grooved) 10 in. diam., 1⅜ in. bore, with two 597c
	597c	Shaft Driving Pulley Clamping Screw...
27636	1165	Treadle.....
	9082	" Bearing Cotter Pin.....
27637	1164	" Pitman Rod (lower).....
27638	2186	" " " " Spring.....
27639	1164	" " " (upper).....
	9079	" " " Clamp with 354c...
	354c	" " " Screw.....
27640	1164	Treadle Pitman complete, Nos. 2762, 9079 and 27637 to 27639.....
	2878	Treadle Stand.....
	2762	" Stop Collar with 362F.....
	362F	" " " Set Screw.....
27642	—	Treadle complete, Nos. 2878, 9082, 27636 and four wood screws 1 in. No. 16.....
27643	—	Treadle and Pitman complete, Nos. 27640 and 27642.....
27889	—	Transmitter complete for 27890, Nos. 354c, 356c, 427E, 927c, 1508E, 2018, 27594, 27595, 27597, 27601, 27605 to 27607, 27631, 27633, 27888, three wood screws 1½ in. No. 16, four 307c and five 1513E.....
27890	—	Under Driver, lever pressure (right hand) two speed, complete, Nos. 27070, 27643 and 27889.....

UNDER DRIVER

LEVER PRESSURE (LEFT HAND) TWO SPEED

This Under Driver is the same as No. 27890 with the following exceptions:

NO.	PLATE	NAME
27596	1164	Dress Guard (left hand) in place of 27888.
27891	—	Transmitter complete for 27892, Nos. 354c, 356c, 427E, 927c, 1508E, 2018, 27594 to 27597, 27601, 27605 to 27607, 27631, 27633, three wood screws 1½ in. No. 16, four 307c and five 1513E, in place of 27889.
27892	—	Under Driver, lever pressure (left hand) two speed, complete, Nos. 27070, 27643 and 27891.

OBSOLETE PARTS

NO.	PLATE	NAME
*42679	—	Arm, upper and lower (solid) with 130b, 9830, 42685, 42697 and two each 462c, 4259c and 42602.
57023	5142	Needle Bar with 2273, for ¼ in. gauge.
57024	5142	Clamp with 707D and 4072E, for ¼ in. gauge, for 57023.
	707D 5147	Needle Clamp Set Screw.
42700	—	Presser Foot with 9311.
57001	5147	Toe.
57002	5147	Spring.
57003	5147	Presser Foot complete, Nos. 707D, 42700, 57001, 57002 and two 9311, use 57021.
57028	5147	Presser Foot for 57027, use 57086.
57005	5142	Thread Eyelet (side of arm).

SINGER Needles should be used
in SINGER Machines.
These Needles and their Containers
are marked with the
Company's Trade Mark "SIMANCO." 1

Needles in Containers marked
"FOR SINGER MACHINES"
are NOT **SINGER** made needles. 2

NUMERICAL LIST OF PARTS

NUMERICAL LIST OF PARTS

NO.	PLATE	NAME
21D	5137	Lifting Lever Hinge Screw for 42659.....
85E	5136	Presser Bar Lifter Screw.....
111F	5137	Thread Nipper Spring Screw.....
130D	5137	Feed Rock Shaft Bracket Screw for 42679 and 57042.....
141E	5137	Looper Carrier Shaft Bracket Screw.....
145F	5137	Thread Unwinder Spool Rest Set Screw for 27450.....
157D	5135	Feed Regulator Clamping Screw for 42670
157D	5135	" Rock Shaft Crank Clamping Screw for 42620.....
157D	5135	Looper Driving Shaft Crank (right, forked) Clamping Screw for 42631.....
171E	5134	Connecting Rod Cap Screw for 57098.....
185H	5137	Presser Bar Lifting Bracket Guide Screw.
185H	5137	" Foot Screw.....
190D	5137	Feed Dog Screw.....
193F	5137	Thread Eyelet Adjusting Screw.....
193F	5137	" " Screw.....
195F	5141	Needle Clamp Screw for 57089.....
197D	5135	Looper Carrier Shaft Crank Clamping Screw for 42692.....
199D	5137	Arm Rotary Shaft Screw.....
207F	5134	Feed Rock Shaft Collar Set Screw for 21509.....
207E	5134	Needle Bar Connecting Stud Clamping Screw for 9570.....
209H	5139	Looper Carrier Set Screw for 42688.....
209F	5139	" " Shaft Bushing Set Screw for 42690.....
217F	5137	Thread Nipper Spring Plate Screw.....
233D	5135	Feed Regulator Stop Screw for 42670.....
234D	5141	Needle Clamp Screw for 57036.....
242D	5147	Presser Foot Toe Spring Screw for 57096.
297C	3826	Band Wheel Crank Screw Centre for 25385
297C	3826	Treadle Screw Centre for 25385.....
307C	2186	Under Driver Brake Bracket Screw Centre for 27889 and 27891.....
307C	2186	Under Driver Lever Screw Centre for 27889 and 27891.....
327E	2186	Under Driver Brake Screw for 27594.....
354C	2186	" " Dress Guard Screw for 27889 and 27891.....

NUMERICAL

LIST

OF PARTS

NO.	PLATE	NAME
354c	2186	Under Driver Treadle Pitman Rod Clamp Screw for 9079.....
356c	3817	Band Wheel Shaft Driving Flange Set Screw for 25429.....
356c	3817	Rock Shaft Knee Arm Hub Set Screw for 2766.....
356c	3817	Rock Shaft Knee Plate Set Screw for 2767
356c	3817	“ “ Lifting Bracket Hook Set Screw for 6337.....
356c	3817	Rock Shaft Lifting Bracket Set Screw for 6337.....
356c	3817	Rock Shaft Stop Dog Set Screw for 2770.
356c	3817	Under Driver Driving Pulley Hollow Stud Set Screw for 27889 and 27891.....
362F	2186	Under Driver Treadle Stop Collar Set Screw for 2762.....
378c	5134	Connecting Rod Hinge Screw.....
387F	5137	Cloth Plate Screw.....
427E	2186	Under Driver Lever Centre Plug Adjusting Screw for 27889 and 27891.....
433c	2186	Under Driver Driving Pulley Screw Centre Bearing for 27597.....
435c	3817	Driving Arm Hinge Pin Set Screw for 25431 and 25432.....
454c	5136	Looper Driving Shaft Collar Set Screw for 19009.....
460c	5142	Thread Take-up Set Screw for 57006....
462c	5135	Needle Bar Bushing (lower) Set Screw for 42679 and 57042.....
462c	5135	Needle Bar Bushing (upper) Set Screw for 42679 and 57042.....
504E	5137	Dress Guard Bolt with 1510E, for 25269..
534E	3817	Driving Segment Bolt with 1510E, for 25258.....
597c	2186	Under Driver Shaft Driving Pulley Clamping Screw for 27070.....
707D	5147	Needle Clamp Set Screw for 57024, obsolete.....
707D	5147	Presser Foot Toe Spring Screw for 57003 and 57021.....
748E	3826	Brace Screw for 25258 and 25269.....
853c	5139	Looper (left hand) Set Screw for 42688...
853c	5139	“ (right hand) Set Screw for 42688.
916c	5142	Tension Screw Stud.....
927c	2186	Under Driver Brake Bracket Adjusting Screw for 27889 and 27891.....
934D	5137	Thread Controller Plate Screw.....

NO.	PLATE	NAME
935D	6932	Machine Cushion Screw for 57008.....
972c	3826	Band Wheel Set Screw for 46536.....
1002c	5142	Lifting Lever Stop Screw for 42659.....
1036c	5139	Looper Cam Set Screw for 42622.....
1038c	5135	Feed Regulator Adjusting Screw.....
1057E	5135	“ Connecting Rod Cap Screw for 42507.....
1057E	5135	Looper Driving Shaft Crank (left) Clamping Screw for 42695.....
1072F	5141	Needle Set Screw for 42698, 57014, 57024 and 57036.....
1121D	5136	Pressure Regulating Thumb Screw.....
1133c	5141	Presser Bar Lifting Bracket Set Screw for 42699.....
1137E	5137	Thread Nipper Thread Guide Screw Stud
1147c	5135	Feed Bar Hinge Stud Set Screw for 42620
1167D	5137	Pulley Screw.....
1230F	5142	Throat Plate Screw.....
1259c	5134	Arm Rock Shaft Crank (back) Position Screw for 42600.....
1259c	5134	Arm Rock Shaft Crank (back) Set Screw for 42600.....
1259c	5134	Arm Rock Shaft Crank (front) Position Screw for 42601.....
1259c	5134	Arm Rock Shaft Crank (front) Set Screw for 42601.....
1259c	5134	Arm Rock Shaft Flanged Bushing (back) Set Screw for 42679 and 57042.....
1259c	5134	Arm Rock Shaft Flanged Bushing (front) Set Screw for 42679 and 57042.....
1259c	5134	Feed Eccentric Position Screw for 42684.
1259c	5134	“ “ Set Screw for 42684.....
1312c	3817	Band Wheel Set Screw for 25329.....
1313E	5135	Needle Bar Connecting Link Adjusting Screw for 34170.....
1380D	5141	Needle Retaining Spring Screw for 57089.
1408J	6931	Machine Thumb Screw, for 2 in. table (Accessories).....
1507E	3826	Band Wheel Crank Screw Centre Nut for 25385.....
1507E	3826	Treadle Screw Centre Nut for 25385.....
1508E	3817	Leg Stay Rod Nut for 25258.....
1508E	2186	Under Driver Lever Centre Plug Adjusting Screw Nut for 27889 and 27891.....
1510E	3817	Dress Guard Bolt Nut for 504.....
1510E	3817	Driving Segment Bolt Nut for 534.....

NO.	PLATE	NAME
1513E	2186	Under Driver Brake Bracket Adjusting Screw Nut for 27889 and 27891.....
1513E	2186	Under Driver Brake Bracket Screw Centre Nut for 27889 and 27891.....
1513E	2186	Under Driver Lever Screw Centre Nut for 27889 and 27891.....
1520E	5134	Connecting Rod Hinge Screw Nut.....
1520E	5134	Needle Bar Connecting Link Screw Stud Nut.....
1520E	3826	Pitman Rod Lock Nut for 46535.....
1560C	5136	Tension Regulating Thumb Nut.....
1589C	5135	Feed Regulator Adjusting Screw Thumb Nut.....
1670E	3826	Pitman Rod Ball Screw Bearing Nut for 46535.....
2018	2186	Under Driver Dress Guard Screw Washer for 27889 and 27891.....
2102	5136	Tension Disc.....
2273	5141	Needle Stop Pin for 42696 and 57023.....
2762	2186	Under Driver Treadle Stop Collar with 362E, for 27640.....
2764	6929	Rock Shaft Hanger (back) with two wood screws 1 in. No. 10, for 16129.....
2766	6929	Rock Shaft Knee Arm Hub with 356C, for 16647.....
2767	6929	Rock Shaft Knee Plate with 356C, for 16647.....
2770	6929	Rock Shaft Stop Dog with 356C, for 16129.....
2878	1165	Under Driver Treadle Stand for 27642.....
5564	3817	Band Wheel Shaft Driver (left) Clutch Spring Hook for 25428.....
5564	3817	Band Wheel Shaft Driver (right) Clutch Spring Hook for 25424.....
6337	6929	Rock Shaft Lifting Bracket with two 356C, for 16129.....
6338	6929	Rock Shaft Lifting Bracket Hook for 16129.....
7070	5135	Feed Regulator Adjusting Screw Sleeve.....
7124	6929	Rock Shaft for 16129.....
7958	2186	Under Driver Driving Pulley Friction Ring Stop Pin for 27597.....
7958	2186	Under Driver Driving Pulley Screw Centre Bearing Dowel Pin for 27597.....
8505	5137	Face Plate Thread Eyelet Rivet for 42681, per 100.....
8505	5137	Thread Controller Spring Rivet for 57004, per 100.....

NO.	PLATE	NAME
8908	6930	Wrench for 1520 (Accessories).....
9079	1164	Under Driver Treadle Pitman Rod Clamp with 354C, for 27640.....
9082	2186	Under Driver Treadle Bearing Cotter Pin for 27642.....
9311	5147	Presser Foot Toe Rivet for 57003, 57021 and 57096..... per 100
9311	5147	Presser Foot Toe Spring Steady Pin for 42700 and 57018..... per 100
9534	5142	Presser Bar Spring.....
9570	5135	Needle Bar Connecting Stud with 207E.....
9830	5135	“ “ Bushing (upper) for 42679 and 57042.....
9842	6932	Machine Thumb Screw Washer (Accessories and Cabinet Trimmings for Stand).....
10243	6932	Thread Unwinder Spool Weight Centre Pin Washer for 41547.....
13710	5142	Tension Spring.....
14063	6932	Machine Thumb Screw Spring (Accessories and Cabinet Trimmings for Stand).....
14224	—	Chain, length 10¼ in., for 42659.....
16128	6929	Rock Shaft Hanger (front) with two wood screws 1 in. No. 10, for 16129.....
16129	6929	Rock Shaft complete for 42659, Nos. 2764, 6337, 6338, 7124, 16128, 16647 and two 2770.....
16646	6929	Rock Shaft Knee Arm for 16647.....
16647	—	Rock Shaft Knee Arm complete for 16129, Nos. 2766, 2767 and 16646.....
17547	5136	Tension Thread Guide (single).....
18154	5139	Looper Driving Shaft Crank Oil Pad (felt) for 42631.....
19009	5136	Looper Driving Shaft Collar with two 454C.....
19081	6932	Lifting Lever Spring for 42659.....
21509	5131	Feed Rock Shaft Collar with 207E.....
22405	5136	Presser Bar Spring Washer.....
25028	3817	Belt Hook for 46544 and 46545.....
25053	2187	Dress Guard for 25269.....
25055	6932	Band Wheel Brake Ball (rubber) for 25269.....
25068	6930	Leg Roller for 25386.....
25069	6930	“ “ Pin for 25386.....
25086	2187	Wrench for 1507, 1510 and 1670, for 25258 and 25269.....
25143	6932	End Leaf Support Lever Hinge Pin for 25162.....
25150	6929	End Leaf Support Lever for 25162.....

NO.	PLATE	NAME
25162	6929	End Leaf Support complete, Nos. 25143, 25150, 25168 and two wood screws $\frac{5}{8}$ in. No. 7 (Cabinet Trimmings for Stand)...
25168	6929	End Leaf Support Bracket for 25162.....
25200	2187	Wrench for 972, for 25269.....
25258	-----	Stand (iron work) high speed, complete, Nos. 25086, 25329, 25122 to 25124, 25126 to 25128, 25431, 25432, 25436, 25437, 25447 to 25449, two each 25349, 25350, 25425, 25429, 25433, 25434, 25451 and four each 534E, 748E, 1508E and 25446.....
25269	----	Stand (iron work) rocking treadle, ball bearing pitman, cover set, complete, Nos. 504E, 25053, 25055, 25086, 25200, 25385, 46518, 46535, 46536, two 25386 and four 748E.....
25329	3813	Band Wheel, 16 in. diam., with 1312c, for 25258.....
25349	3813	Foot Rest for 25258.....
25350	3817	" " Cotter Pin for 25258.....
*25360	----	Pitman Rod Ball for 46517.....
25361	3826	" " " " Screw Bearing for 46535.....
25362	3826	" " Ball, size $\frac{3}{16}$ in., for 46535 per 100.....
25371	3826	" " Rod Ball Bushing for 46535.....
25385	2187	Brace with three each 297c and 1507E, for 25269.....
25386	2187	Leg with two each 25068 and 25069, for 25269.....
		Nos. 25422 to 25429 FOR 25258.
25422	3815	Band Wheel Shaft Driver (right).....
25423	3815	" " " " " Clutch (left).....
25424	3815	Band Wheel Shaft Driver (right) Clutch (right) with 5564.....
25425	3817	Band Wheel Shaft Driver (left) Clutch Spring.....
25425	3817	Band Wheel Shaft Driver (right) Clutch Spring.....
25426	3815	Band Wheel Shaft Driver (left).....
25427	3815	" " " " " Clutch (left).....
25428	3815	Band Wheel Shaft Driver (left) Clutch (right) with 5564.....
25429	3815	Band Wheel Shaft Driving Flange with 356c.....

NO.	PLATE	NAME
		Nos. 25431 to 25434 FOR 25258.
25431	3813	Driving Arm (left) with 435c and 25435..
25432	3813	" " (right) with 435c and 25435.
25433	3816	" " Hinge Pin.....
25434	3815	" " Pinion.....
25435	3816	Foot Rest Hinge Pin for 25431 and 25432.
25436	3813	Leg (left) for 25258.....
25437	3813	" (right) for 25258.....
		Nos. 25446 to 25449 FOR 25258.
25446	3817	Driving Segment Bolt Nut Washer.....
25447	3818	Band Wheel Shaft.....
25448	3818	Brace.....
25449	3818	Leg Stay Rod.....
25451	3813	Driving Segment (rack) for 25258.....
26026	6930	Screw Driver, large (Accessories).....
26185	6930	" " small (Accessories).....
27070	1165	Under Driver Shaft Driving Pulley (sectional, grooved) 10 in. diam., $1\frac{3}{8}$ in. bore, with two 597c, for 27890 and 27892.....
27446	6929	Thread Unwinder Thread Eyelet Wire (left) for 27451.....
27450	6929	Thread Unwinder Spool Rest with 145F and two 27702, for 41831.....
27451	6929	Thread Unwinder Stand for 41831.....
27452	6929	" " Thread Eyelet Wire (right) for 27451.....
27453	6929	Thread Unwinder Thread Eyelet Rod for 27451.....
27454		Thread Unwinder Thread Eyelet complete for 41831, Nos. 27446, 27452 and 27453
27473	2186	Under Driver Cone Pulley Centre Bearing for 27595.....
27593	6930	Under Driver Brake (fibre) for 27594....
27594	1164	" " " Bracket with 27593 and two 327E, for 27889 and 27891.....
27595	1164	Under Driver Cone Pulley (grooved) two speed, $4\frac{1}{2}$ in. and $5\frac{1}{2}$ in. diam., with 27473, for 27889 and 27891.....
27596	1164	Under Driver Dress Guard (left hand) for 27891.....
27597	1164	Under Driver Driving Pulley (grooved) $6\frac{1}{4}$ in. diam., with 433c, 27598 and two 7958, for 27889 and 27891.....
27598	----	Under Driver Driving Pulley Friction Ring (leather) for 27597.....

NO.	PLATE	NAME
27600	2186	Under Driver Driving Pulley Hollow Stud Position Stud for 27631.....
27601	1164	Under Driver Frame for 27889 and 27891.
Nos. 27605 TO 27607 FOR 27889 AND 27891.		
27605	1164	Under Driver Lever.....
27606	2186	“ “ “ Centre Plug (wood).....
27607	6930	“ “ “ Spring.....
27631	2186	“ “ Driving Pulley Hollow Stud with 27600, for 27889 and 27891.....
27632	-----	Under Driver Driving Pulley Hollow Stud Wick for 27633.....
27633	-----	Under Driver Driving Pulley Hollow Stud Wick Wire with 27632, for 27889 and 27891.....
27636	1165	Under Driver Treadle for 27642.....
Nos. 27637 TO 27639 FOR 27640.		
27637	1164	Under Driver Treadle Pitman Rod (lower)
27638	2186	“ “ “ “ “ “ Spring.....
27639	1164	Under Driver Treadle Pitman Rod (upper)
27640	1164	Under Driver Treadle Pitman complete for 27643, Nos. 2762, 9079 and 27637 to 27639.....
27642	-----	Under Driver Treadle complete for 27643, Nos. 2878, 9082, 27636 and four wood screws 1 in. No. 16.....
27643	-----	Under Driver Treadle and Pitman complete for 27890 and 27892, Nos. 27640 and 27642.....
27702	6932	Thread Unwinder Spool Pin for 27450....
27888	6929	Under Driver Dress Guard (right hand) for 27889.....
27889	-----	Under Driver Transmitter complete for 27890, Nos. 354c, 356c, 427E, 927c, 1508E, 2018, 27594, 27595, 27597, 27601, 27605 to 27607, 27631, 27633, 27888, three wood screws 1½ in. No. 16, four 307c and five 1513E.....
27890	-----	Under Driver, lever pressure (right hand) two speed, complete, Nos. 27070, 27643 and 27889.....

NO.	PLATE	NAME
27891	-----	Under Driver Transmitter complete for 27892, Nos. 354c, 356c, 427E, 927c, 1508E, 2018, 27594 to 27597, 27601, 27605 to 27607, 27631, 27633, three wood screws 1½ in. No. 16, four 307c and five 1513E.....
27892	-----	Under Driver, lever pressure (left hand) two speed, complete, Nos. 27070, 27643 and 27891.....
28013	6930	Belt Hole Bushing, round, brass (Cabinet Trimmings for Stand).....
28079	6930	End Leaf Hinge (Cabinet Trimmings for Stand).....
28270	2187	Band Wheel Crank for 46535.....
32026	5133	Balance Wheel.....
32027	5133	Pulley, 2¼ in. diam.....
34103	5136	Presser Bar.....
34170	5135	Needle Bar Connecting Link with two 1313E.....
34224	5137	Thread Controller Spring for 57004.....
*34434	-----	Connecting Rod Cap for 57098.....
35143	6930	Tweezers, 4 in. (Accessories).....
36569	6930	Oiler with 36571, for 36570.....
36570	-----	“ 36569, filled with oil (Accessories).....
36571	6930	“ Spout, 1¾ in. long, with 36807, for 36569.....
36807	6932	Oiler Spout Washer (leather) for 36571....
38540	5136	Presser Bar Lifter.....
*38588	-----	Feed Connecting Rod Cap for 42507.....
41541	6930	Thread Unwinder Spool Weight Thread Guide with 41542, for 41831.....
41542	6932	Thread Unwinder Spool Weight Thread Guide Centre Pin for 41541.....
41546	6932	Thread Unwinder Spool Weight Centre Pin for 41547.....
41547	-----	Thread Unwinder Spool Weight complete for 41831, Nos. 10243 and 41546.....
41831	6929	Thread Unwinder complete, for two small spools, Nos. 27450, 27451, 27454, two each 41541, 41547 and three wood screws 1 in. No. 10.....
42088	6932	Machine Cushion (felt) for 57008.....
42507	5135	Feed Connecting Rod with 38588 and two 1057E.....
42599	5133	Arm Rock Shaft.....
42600	5134	“ “ “ Crank (back) with two 1259c.....

NO.	PLATE	NAME
42601	5134	Arm Rock Shaft Crank (front) with two 1259c.....
42602	5134	Arm Rock Shaft Flanged Bushing (back) for 42679 and 57042.....
42602	5134	Arm Rock Shaft Flanged Bushing (front) for 42679 and 57042.....
42613	5134	Feed Bar.....
42614	5134	" " Hinge Stud.....
42615	5134	" " Slide Block.....
42618	5134	" Rock Shaft.....
42620	5135	" " " Crank with 157b and 1147c.....
42622	5139	Looper Cam (double) with two 1036c....
42631	5139	" Driving Shaft Crank (right, forked) with 157b and 18154.....
42632	5141	Presser Bar Lifting Bracket, Guide.....
42658	5140	Lifting Lever for 42659.....
42659	—	Knee Lifter complete (power table) Nos. 21b, 1002c, 14224, 16129, 19081 and 42658.....
42670	5135	Feed Regulator with 157b and 233b.....
*42679	—	Arm, upper and lower (solid) with 130b, 9830, 42685, 42697 and two each 462c 1259c and 42602, obsolete.....
42680	5138	Cloth Plate (narrow).....
42681	5139	Face Plate with 8505 and 42682.....
42682	5139	" " Thread Eyelet (double) for 42681.....
42683	5114	Feed Dog, for $\frac{5}{8}$ in. to $\frac{1}{8}$ in. gauge, for two line chain embroidery.....
42684	5135	Feed Eccentric with two 1259c.....
42685	5140	" Rock Shaft Bracket for 42679 and 57042.....
42686	5139	Looper (left hand) for $\frac{1}{16}$ in. to $\frac{3}{4}$ in. gauge.....
42687	5139	Looper (right hand) for $\frac{1}{16}$ in. gauge and above and (left hand) for $\frac{1}{8}$ in. gauge and above.....
42688	5139	Looper Carrier with 209n and two 853c....
42689	5139	" " Shaft.....
42690	5110	" " " Bracket with 209e....
42691	5135	" " " Bushing.....
42692	5135	" " " Crank with 197b....
42693	5139	" " " " Connecting Link.....
42694	5136	Looper Driving Shaft.....

NO.	PLATE	NAME
42695	5139	Looper Driving Shaft Crank (left) with 1057e.....
42696	5141	Needle Bar with 2273, for $\frac{3}{8}$ in. to $\frac{1}{8}$ in. gauge.....
42697	5141	Needle Bar Bushing (lower) for 42679 and 57042.....
42698	5141	Needle Clamp with 1072f, for $\frac{5}{8}$ in. and $\frac{3}{2}$ in. gauges, for 42696.....
42699	5141	Presser Bar Lifting Bracket with 1133c....
42700	—	" Foot with 9311, for 57003, obsolete Nos. 46506 to 46509 for 46535.
46506	3826	Pitman Ball Bearing Adjusting Screw Ring.....
46507	3826	Pitman Ball Bearing Adjusting Screw Ring Locking Washer (brass) per 100
46508	3826	Pitman Ball Bearing Ring.....
46509	3826	" " Case.....
46517	2187	" Rod with 25360, for 46535.....
46518	2187	Treadle for 25269.....
46535	—	Band Wheel Crank and Pitman (ball bearing) complete for 25269, Nos. 1520e, 1670e, 25361, 25371, 28270, 46506 to 46509, 46517 and eleven 25362
46536	2187	Band Wheel, 13 in. diam., with 972c, for 25269.....
46544	—	Belt, size $\frac{5}{2}$ in., length 58 $\frac{1}{2}$ in., with 25028, for 25258.....
46545	—	Belt, size $\frac{5}{2}$ in., length 54 $\frac{1}{2}$ in., with 25028, for 25269.....
50026e	5135	Needle Bar Connecting Link Screw Stud.
50150c	5137	Thread Nipper Cam Set Screw for 57043.
50314a	6931	Machine Thumb Screw (Cabinet Trimmings for Stand).....
50318b	5137	Face Plate Screw.....
51648	5136	Looper Driving Shaft Oil Pad (braided cotton).....
57001	5147	Presser Foot Toe for 57003, obsolete.....
57002	5147	" " " Spring for 57003, obsolete.....
57003	5147	Presser Foot complete, Nos. 707b, 42700, 57001, 57002 and two 9311, obsolete, use 57021.....
57004	5137	Thread Controller Plate with 34224 and two 8505.....
57005	5142	Thread Eyelet (side of arm) obsolete....
57006	5142	" Take-up with 460c.....

NO.	PLATE	NAME
57007	5144	Throat Plate (grooved) for 42683.....
57008	6929	Machine Base with three wood screws 1¼ in. No. 12 and four each 935D and 42088.....
57010	5145	Feed Dog, for ¼ in. to ⅝ in. gauge, for Paris pointing.....
57011	5147	Presser Foot, grooved on bottom, for silk mitts, for 57010.....
57012	5147	Presser Foot, grooved on bottom, for Paris points, for 57010.....
57013	5145	Throat Plate (flush) for 57010.....
57014	5141	Needle Clamp with 1072F, for ¼ in. and ⅕ in. gauges, for 42696.....
57016	5133	Arm Rotary Shaft.....
57017	5138	Cloth Plate (wide).....
Nos. 57018 to 57020 for 57021.		
57018	---	Presser Foot with 9311.....
57019	5147	" " Toe.....
57020	5147	" " Spring.....
57021	5147	Presser Foot complete for 42683, Nos. 707D, 57018 to 57020 and two 9311....
57022	5143	Feed Dog, for ⅙ in. gauge, for inserting glove thumbs.....
57023	5142	Needle Bar with 2273, for ⅙ in. gauge, obsolete.....
57024	5142	Needle Clamp with 707D and 1072F, for ⅙ in. gauge, for 57023, obsolete.....
57025	5147	Presser Foot for 57022.....
57026	5143	Throat Plate for 57022.....
57027	5143	Feed Dog, for ⅙ in. gauge, for silking the backs of light weight leather gloves....
57028	5147	Presser Foot for 57027, obsolete, use 57086.....
57029	5143	Throat Plate for 57027.....
57031	5144	Feed Dog, for ⅙ in. gauge, for stitching around air tucks on backs of leather gloves.....
57032	5147	Presser Foot for 57031.....
57033	5144	Throat Plate for 57031.....
57034	5146	Feed Dog, for ¾ in. to ⅞ in. gauge, for two line chain embroidery.....
57035	5141	Needle Bar, for ¾ in. to ⅞ in. gauge....
57036	5141	" Clamp with two 1072F, for ¾ in. to ⅞ in. gauge, for 57035.....
57037	5147	Presser Foot for 57034.....
57038	5146	Throat Plate (grooved) for 57034.....

NO.	PLATE	NAME
*57042	---	Arm, upper and lower (solid) with 130D, 9830, 42685, 42697 and two each 462c, 1259c and 42602.....
57043	5137	Thread Nipper Cam with 50150c.....
57044	5137	" " Spring.....
57045	5137	" " Plate.....
57046	5137	" " Stud.....
57076	5136	Tension Thread Guide (double).....
57077	5137	Thread Eyelet (side of arm).....
57082	5145	Feed Dog, for ⅜ in. to ⅝ in. gauge, for inserting glove thumbs.....
57083	5147	Presser Foot for 57082.....
57084	5145	Throat Plate for 57082.....
57086	5147	Presser Foot for 57027.....
57087	5141	Needle Bar with 57091, for ⅙ in. gauge..
57088	---	" Clamp Body for 57089.....
57089	5111	Needle Clamp complete, for ⅙ in. gauge, for 57087, Nos. 195F, 1380D, 57088 and 57090.....
57090	5141	Needle Retaining Spring for 57089.....
57091	5141	" Stop Pin for 57087.....
57092	5146	Feed Dog, for ⅙ in. gauge, for two or three rows of stitching and two line em- broidery.....
Nos. 57093 to 57095 for 57096.		
57093	---	Presser Foot.....
57094	5147	" " Toe.....
57095	5147	" " Spring.....
57096	5147	Presser Foot complete for 57092, Nos. 242D, 57093 to 57095 and two 9311....
57097	5146	Throat Plate for 57092.....
57098	5134	Connecting Rod with 31434 and two 171E

SINGER Needles should be used
in SINGER Machines.
These Needles and their Containers
are marked with the
Company's Trade Mark "SIMANCO. ***" 1

Needles in Containers marked
"FOR SINGER MACHINES"
are NOT **SINGER** made needles. 2

**ILLUSTRATIONS
OF
PARTS**

PLATE 1164—ONE-FOURTH SIZE

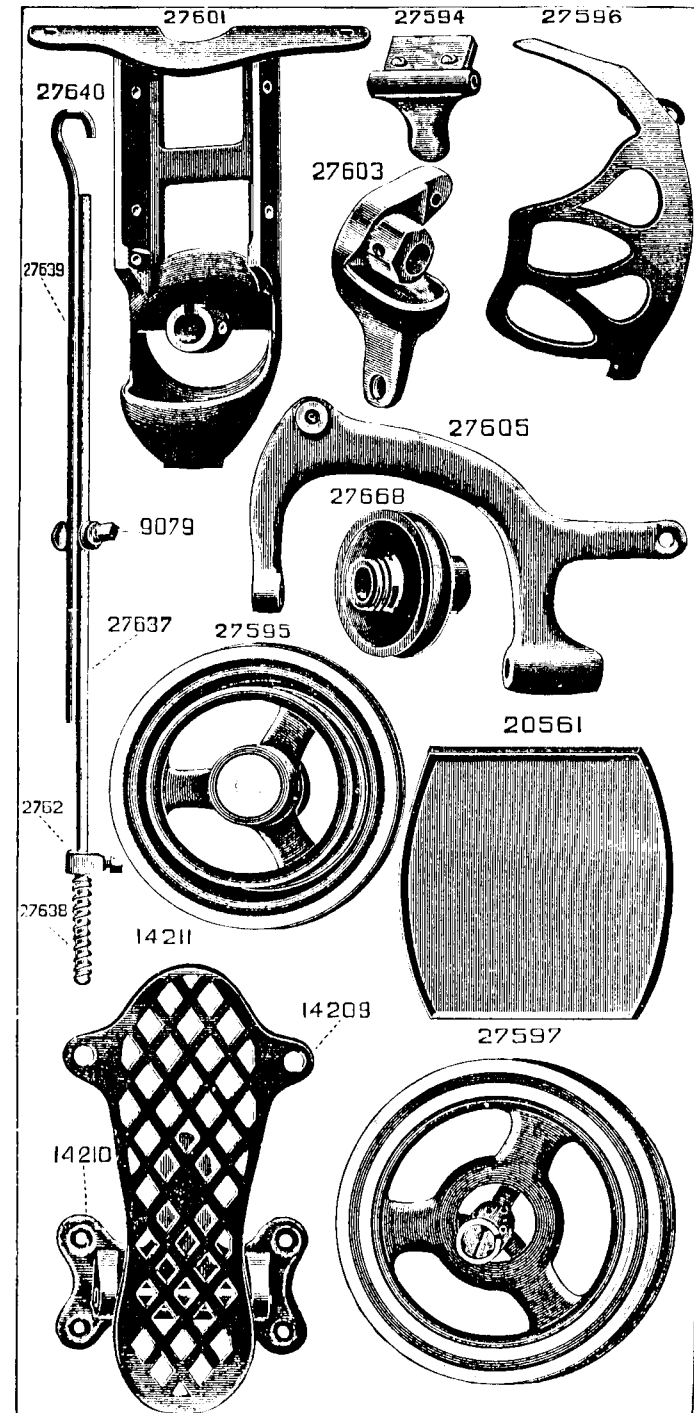

ILLUSTRATIONS

OF

PARTS

PLATE 1165—ONE-FOURTH SIZE

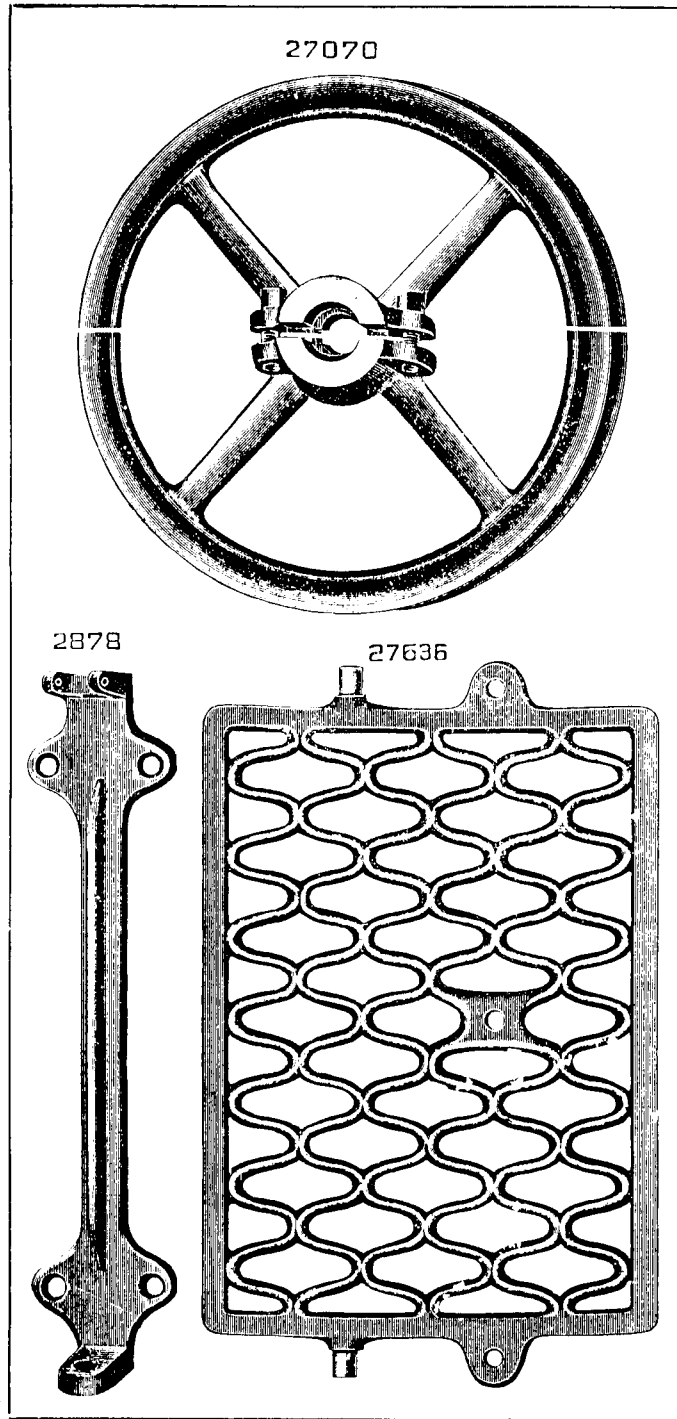

PLATE 2186—FULL SIZE

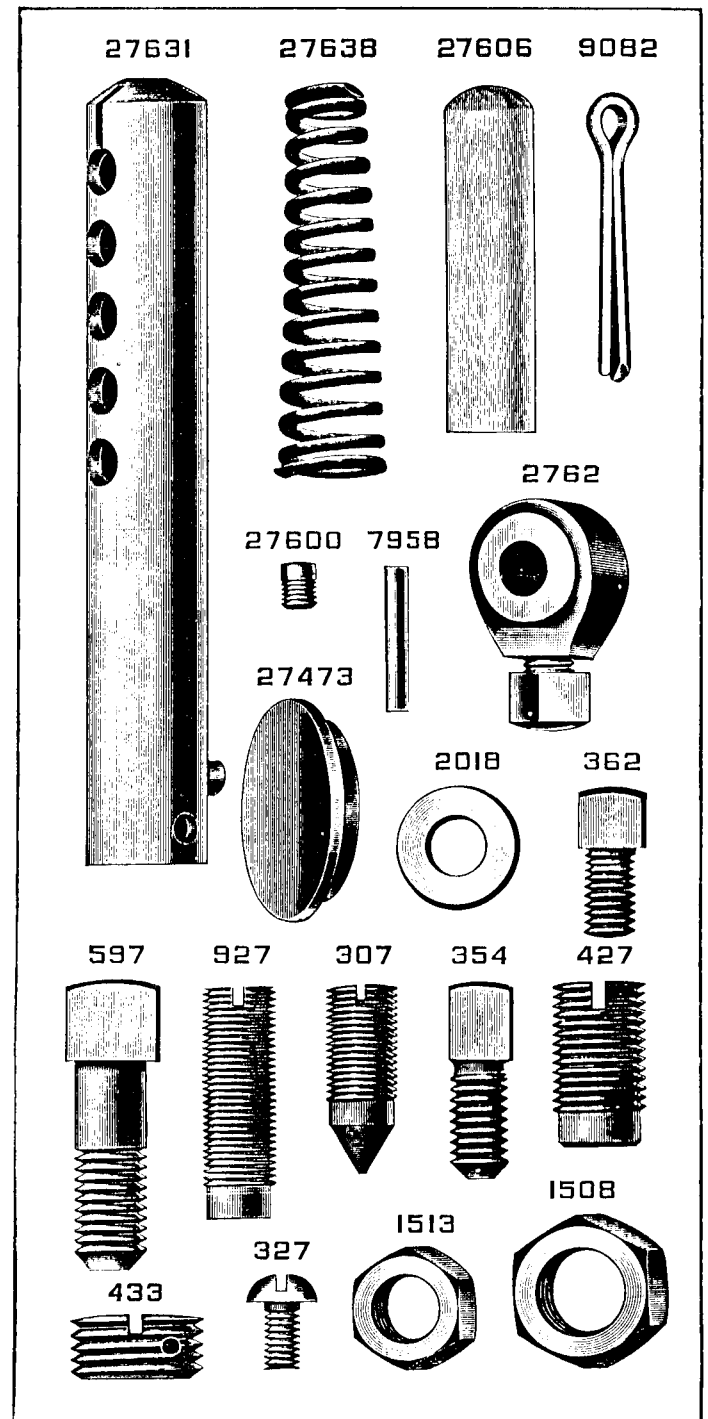

PLATE 2187—ONE-NINTH SIZE

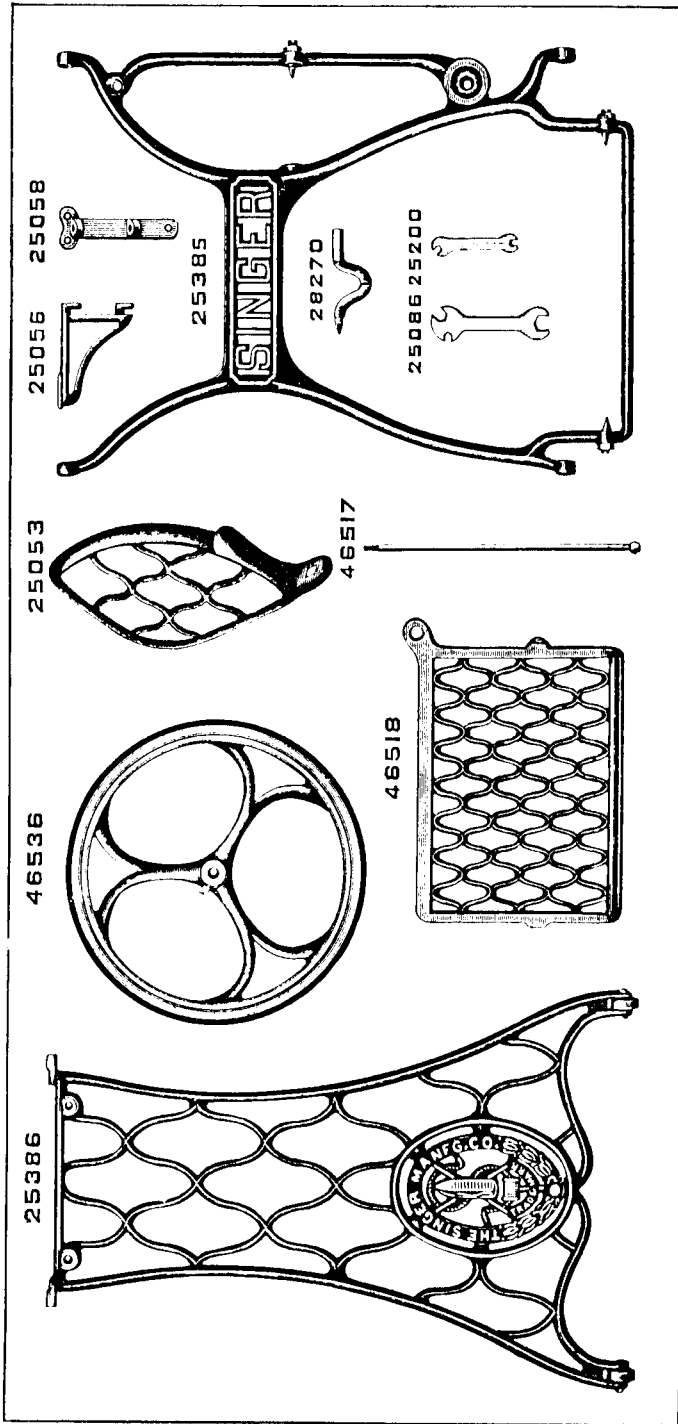

PLATE 3813—ONE-NINTH SIZE

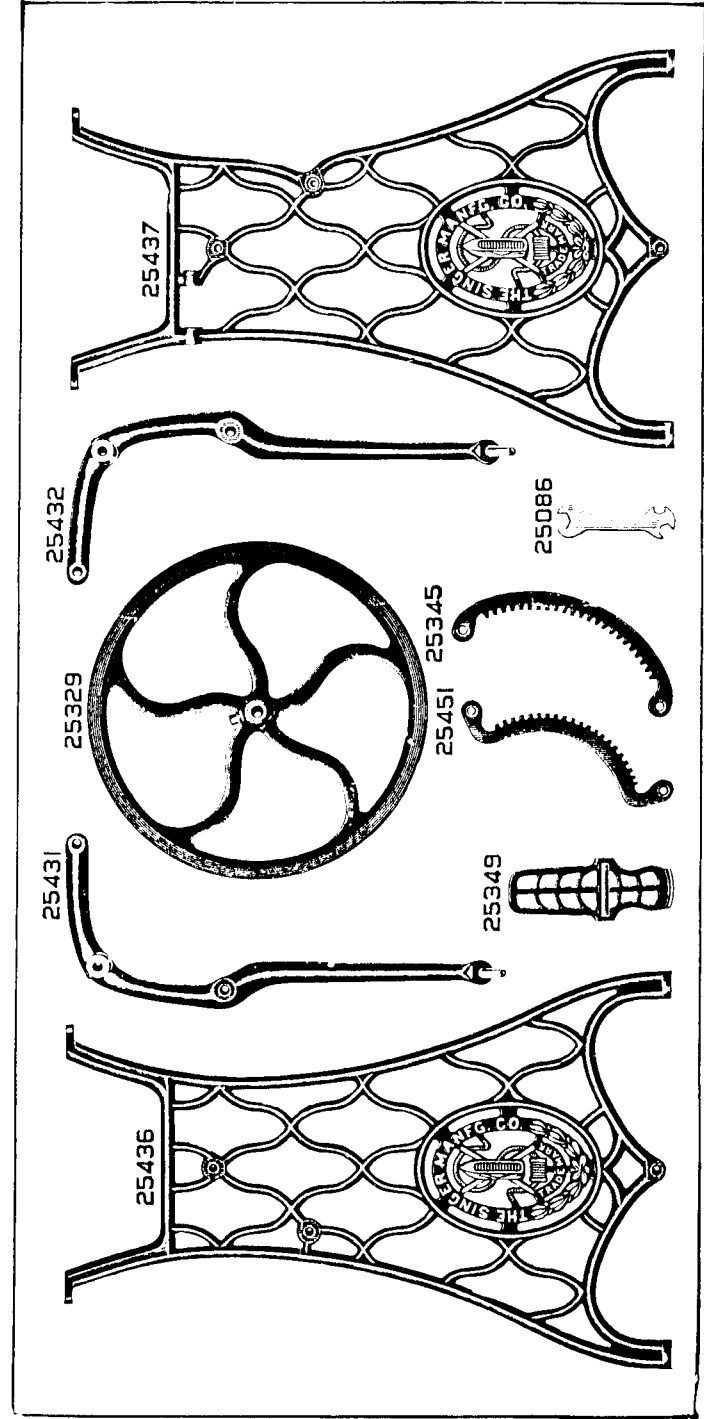

PLATE 3815—ONE-HALF SIZE

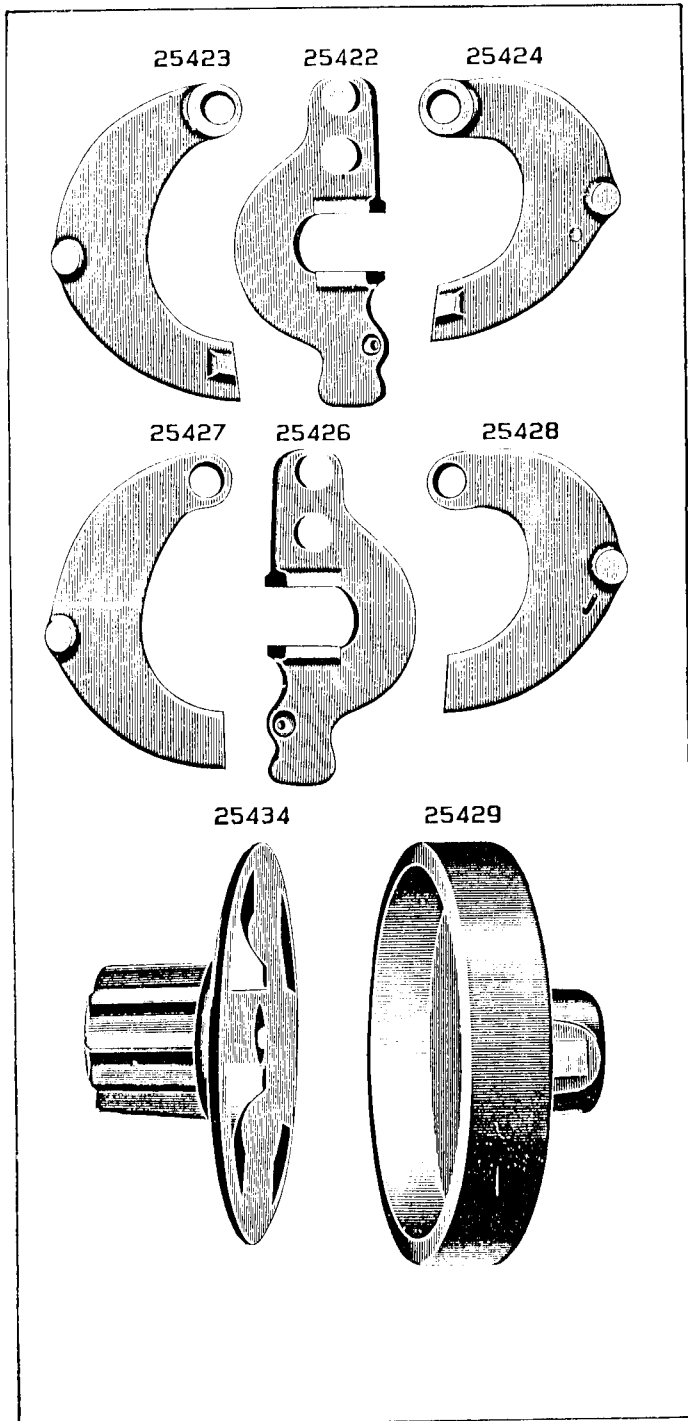

PLATE 3816—ONE-HALF SIZE

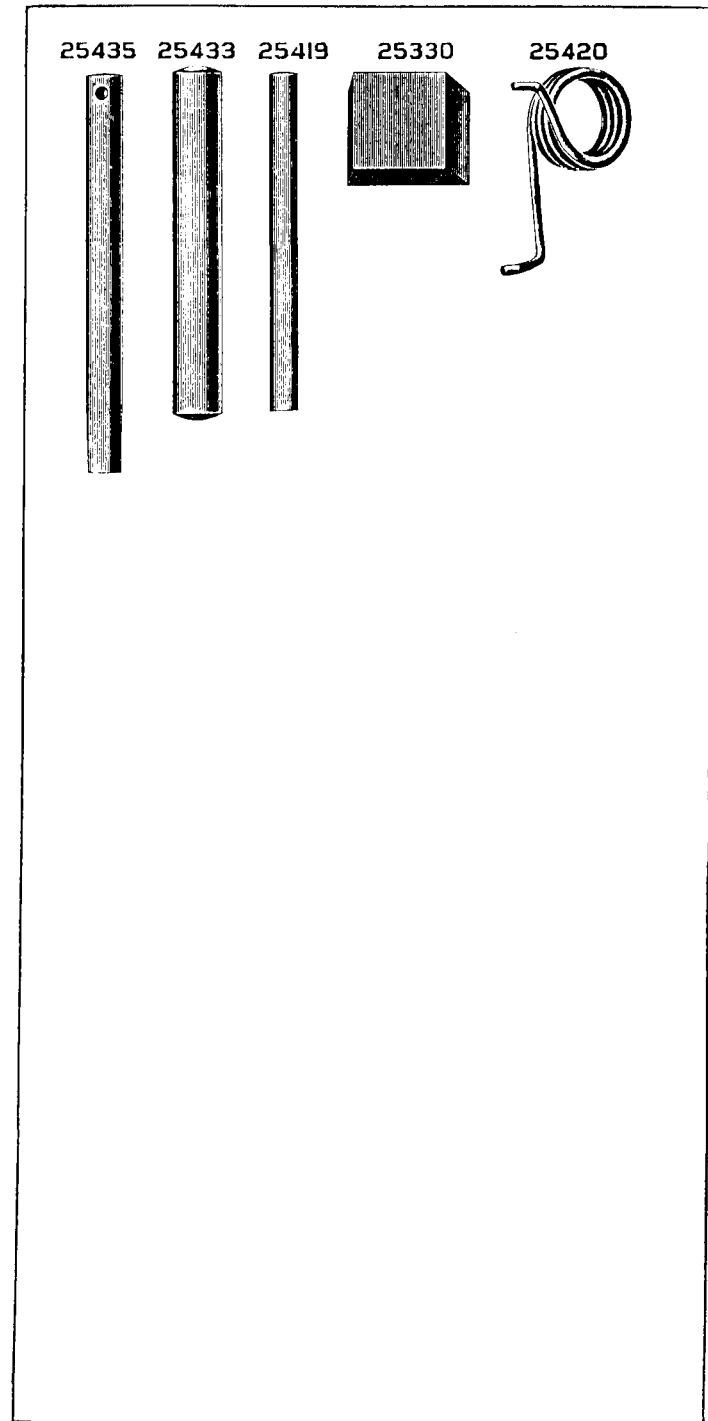

PLATE 3817—FULL SIZE

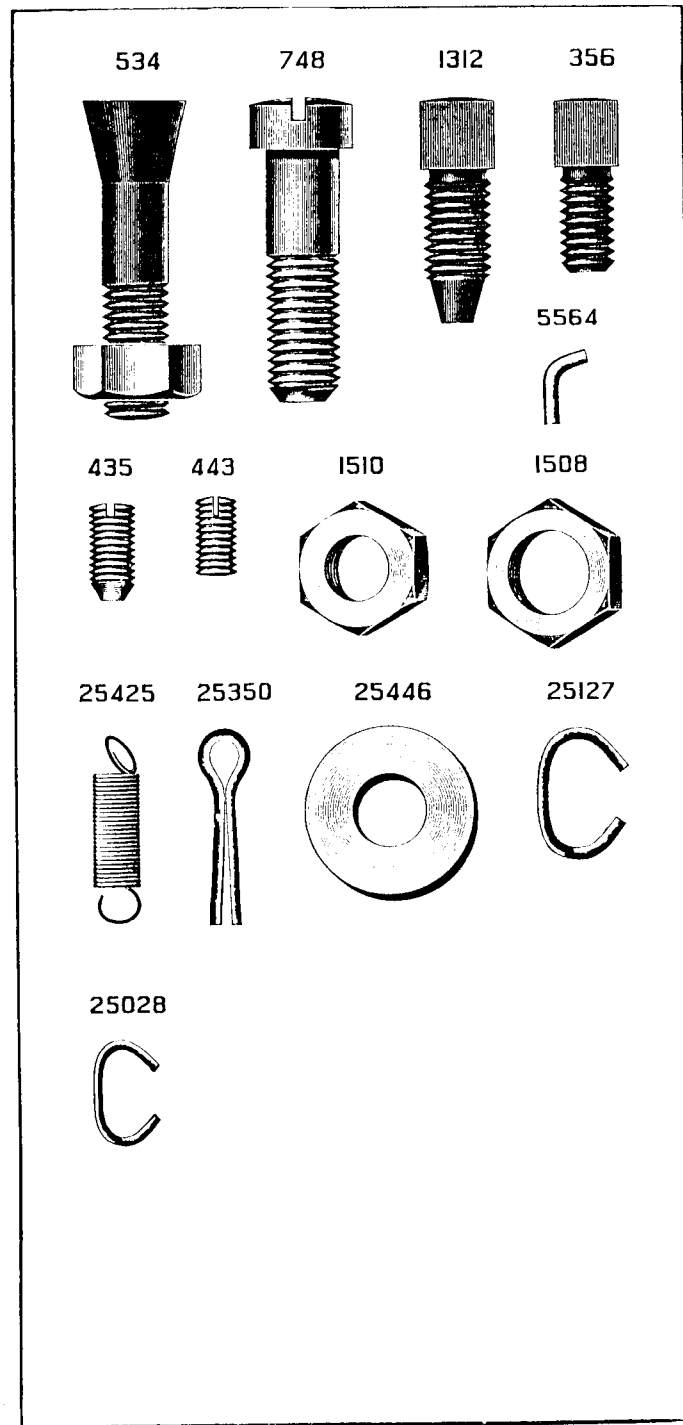

PLATE 3818—ONE-NINTH SIZE

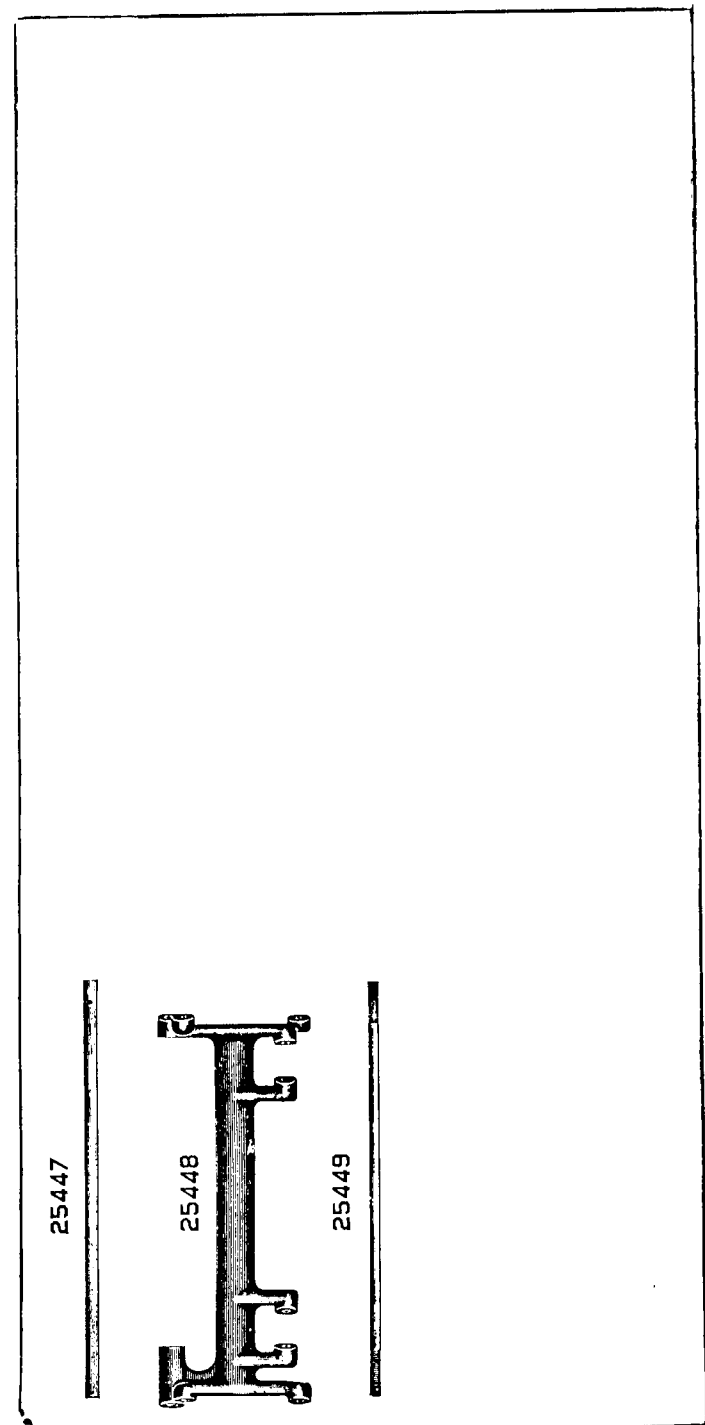

PLATE 3826—FULL SIZE

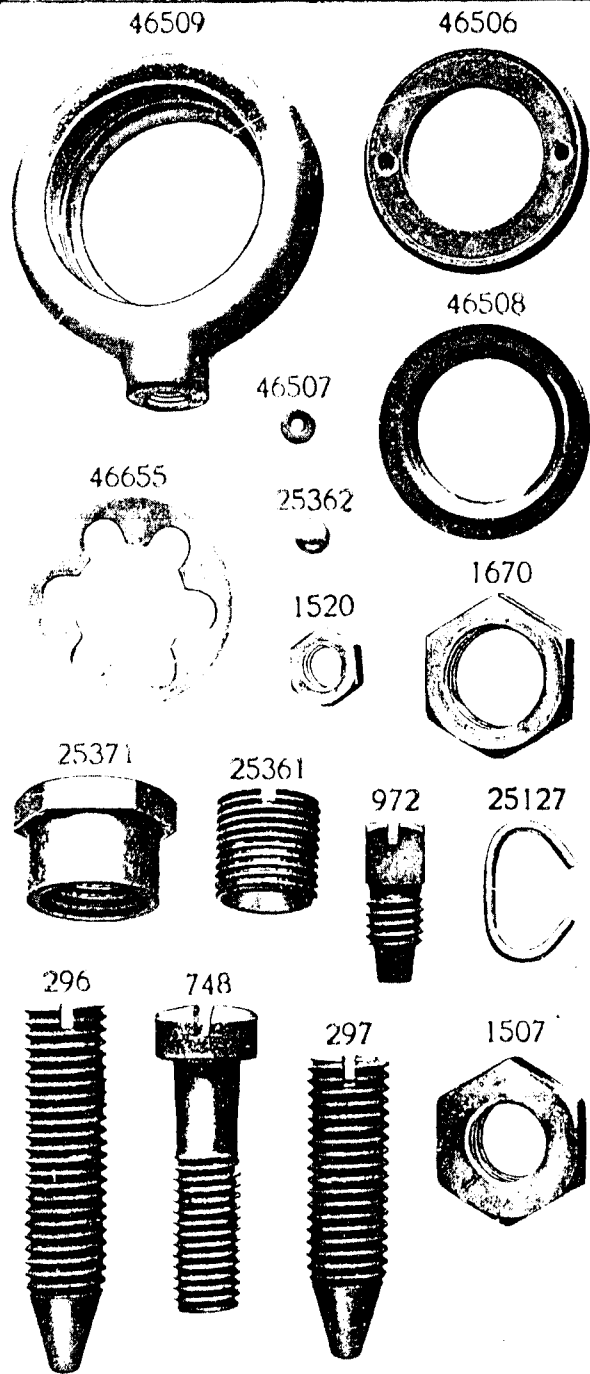

PLATE 5133—ONE-HALF SIZE

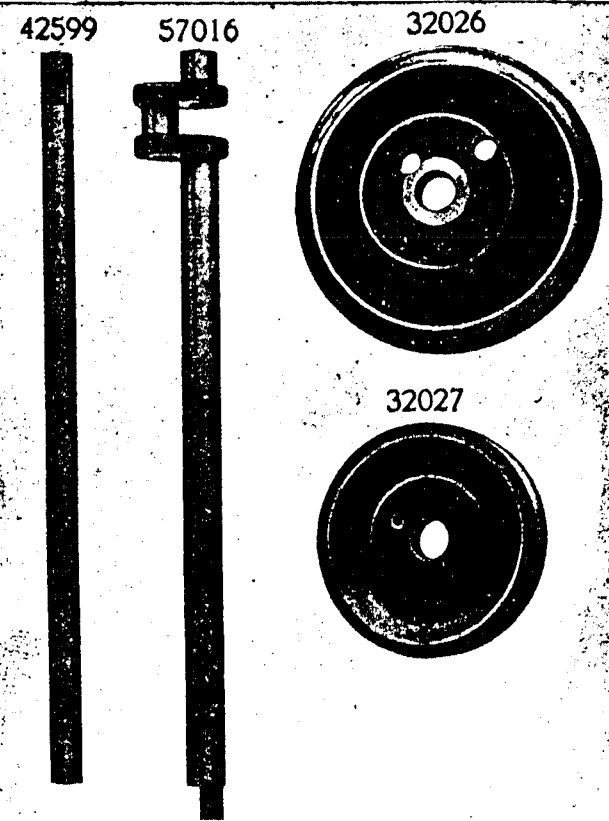

PLATE 5134—FULL SIZE

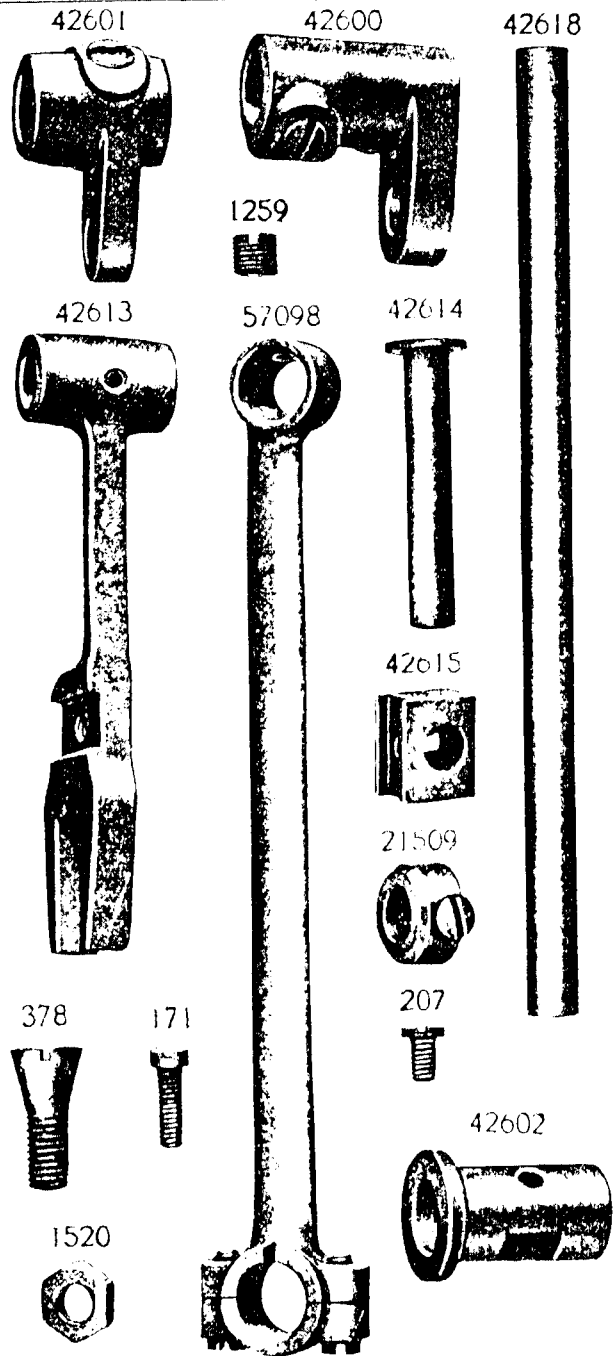

PLATE 5135—FULL SIZE

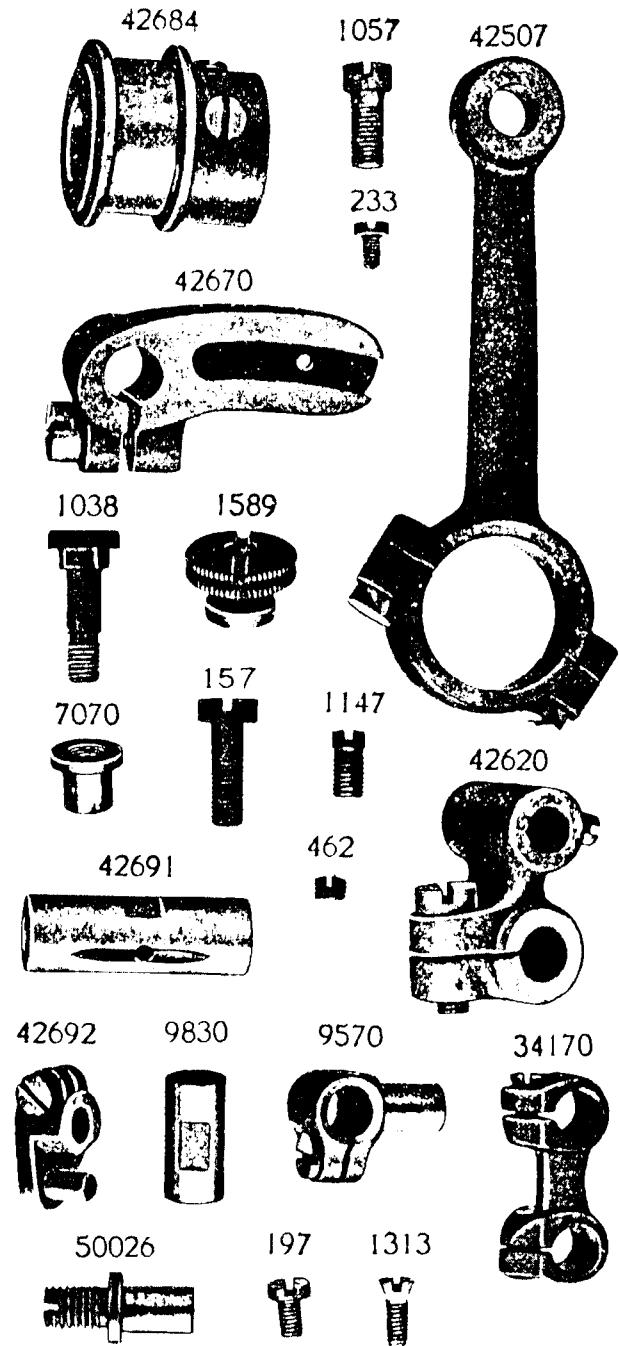

PLATE 5136--FULL SIZE

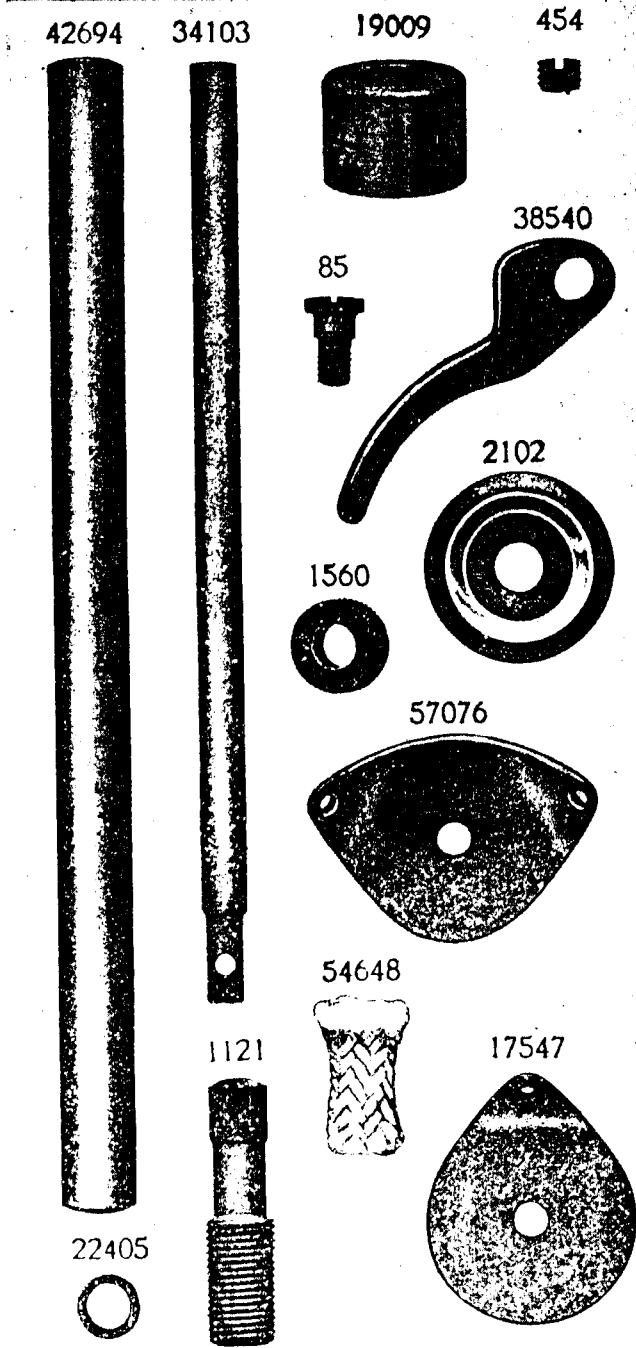

PLATE 5137--FULL SIZE

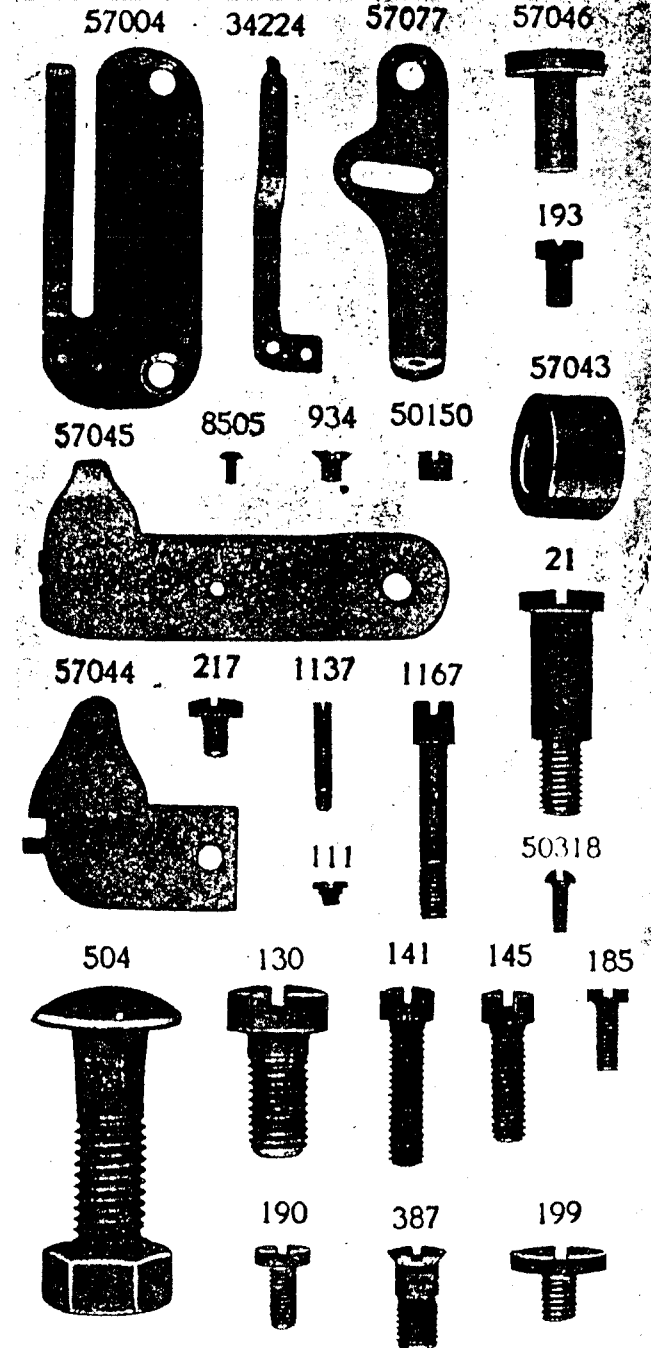
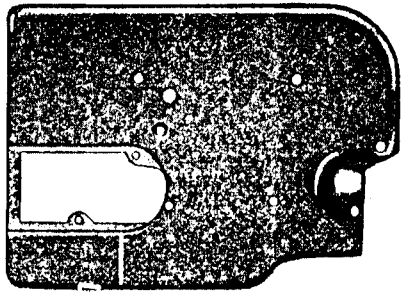

PLATE 5138—ONE-FOURTH SIZE

42680



57017

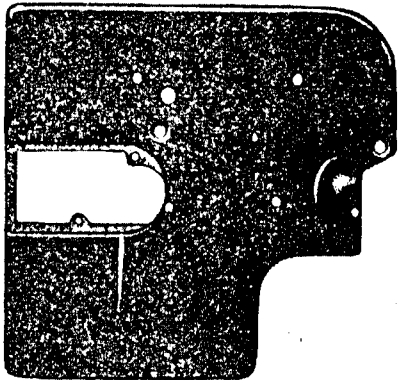
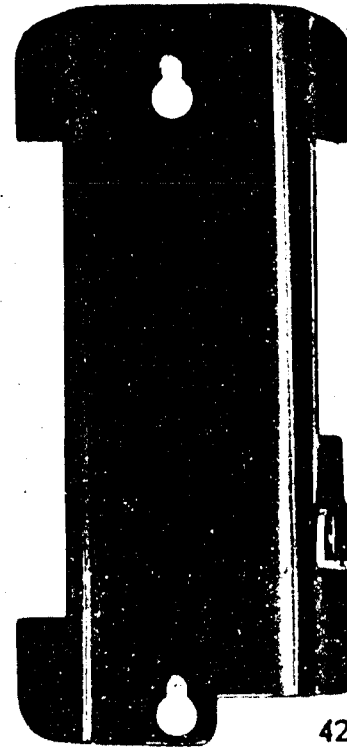

PLATE 5139—FULL SIZE

42681



42686



853



42689



42687



42688



209



42693



42695

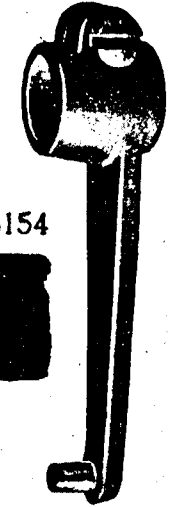

42682



18154



42631



1036



42622

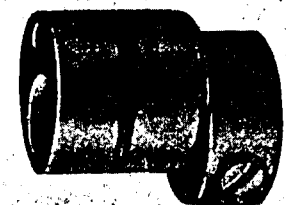
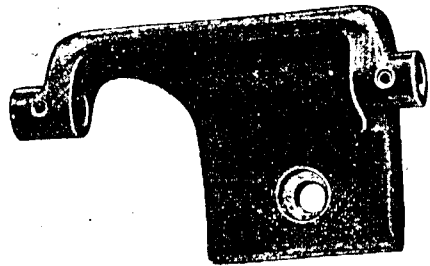

PLATE 5140—ONE-HALF SIZE

42685



42658



42690

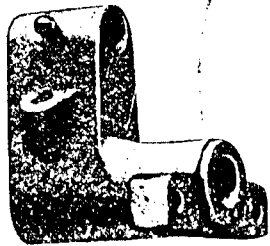

PLATE 5141—FULL SIZE

42696



57087



57035



42697



42698

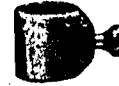

57014



57036

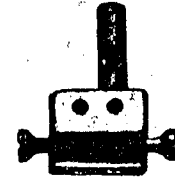

234



1072



57091



2273



42632



42699



1133



57089



195



57090



1380



PLATE 5142—FULL SIZE

57023



13710



460



57006



9534



1002



916



1230



57024



57005



PLATE 5143—FULL SIZE

57026

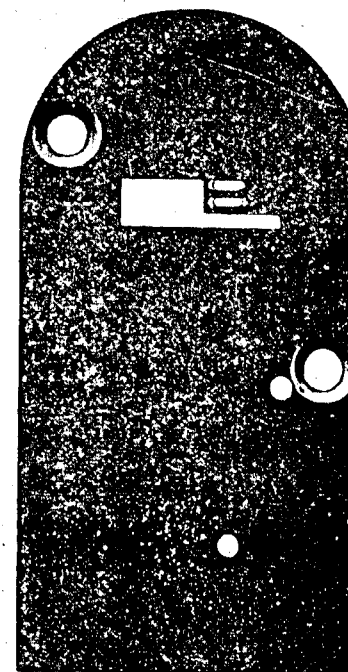

57022



57029

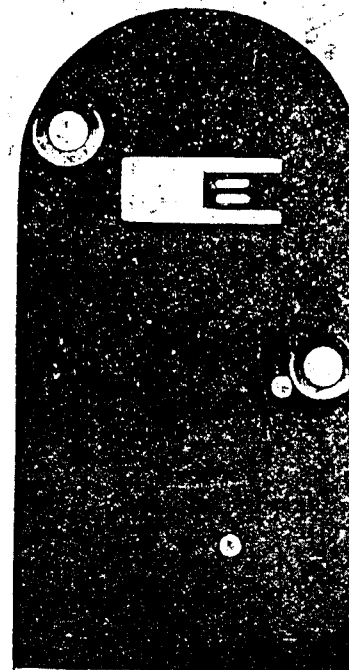

57027

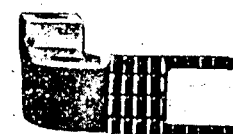
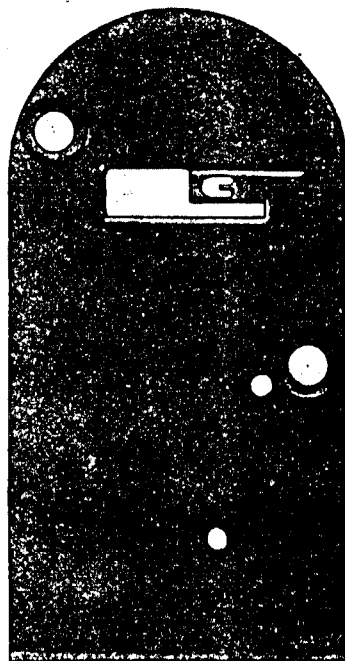

PLATE 5144—FULL SIZE

57033

57031



57007

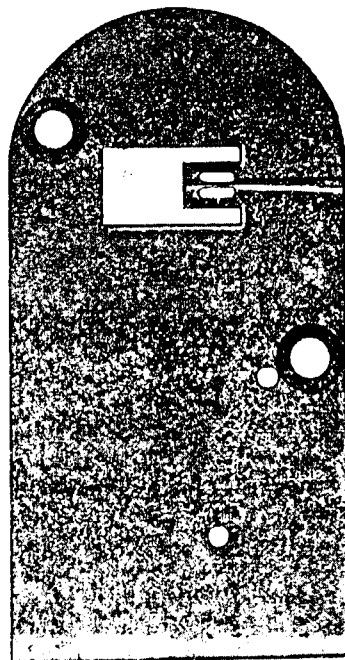

42683



PLATE 5145—FULL SIZE

57013

57010

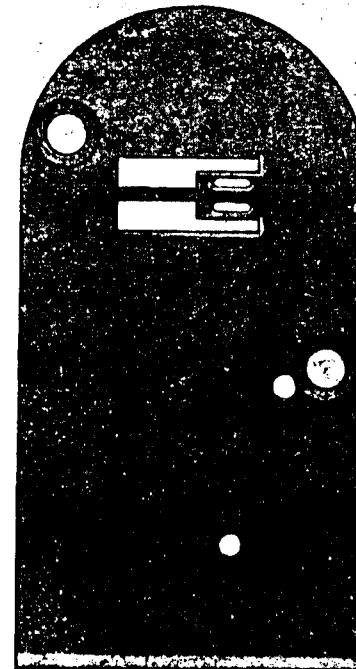

57084

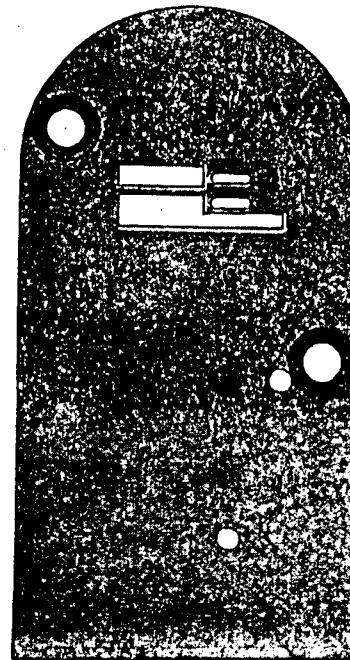

57082



PLATE 5146—FULL SIZE

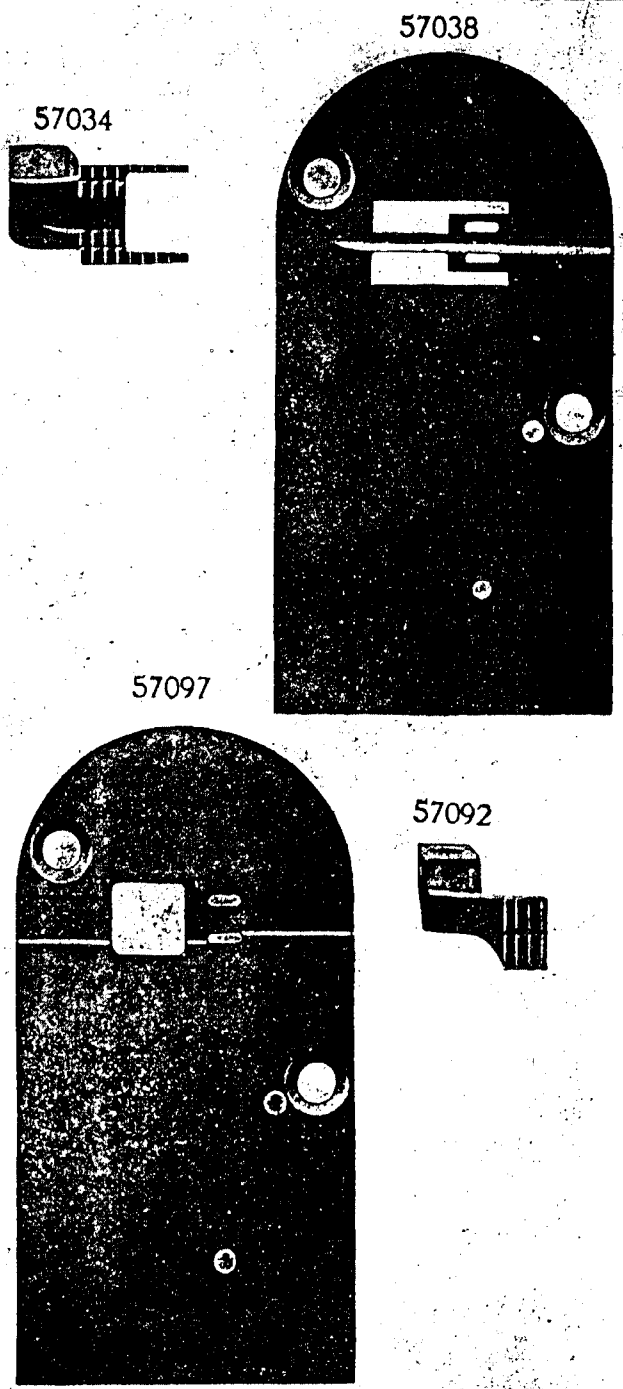

PLATE 5147—FULL SIZE

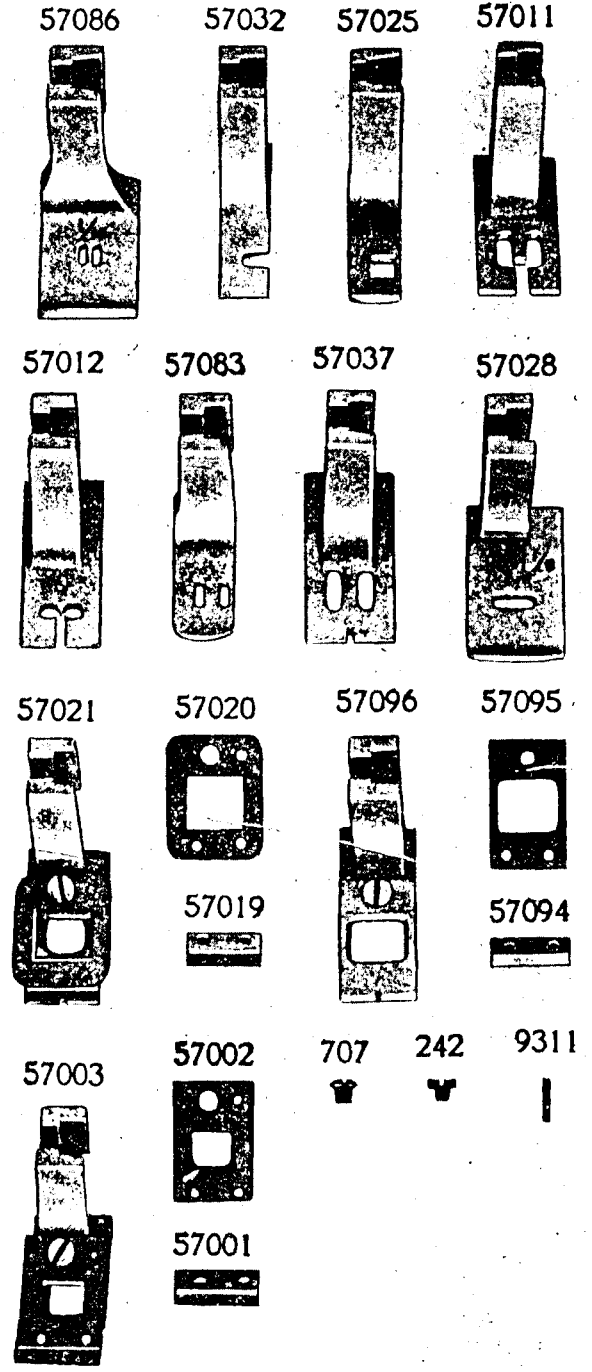

PLATE 6929—ONE-FOURTH SIZE

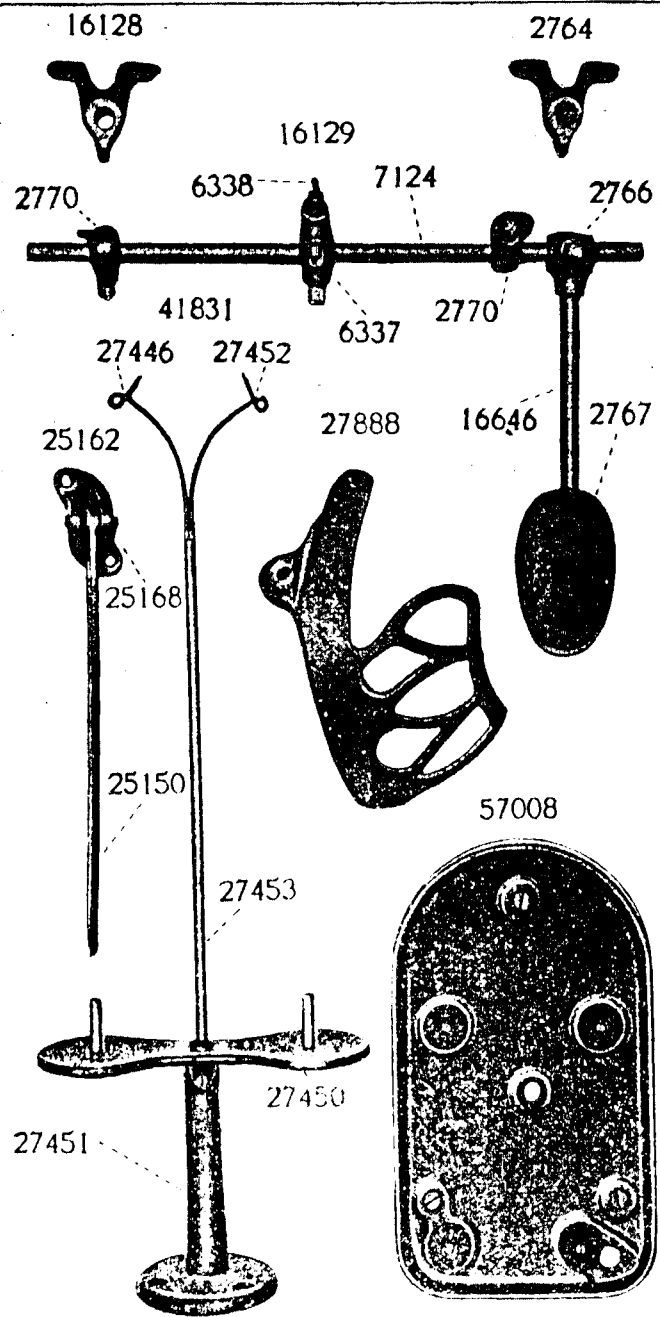

PLATE 6930—ONE-HALF SIZE

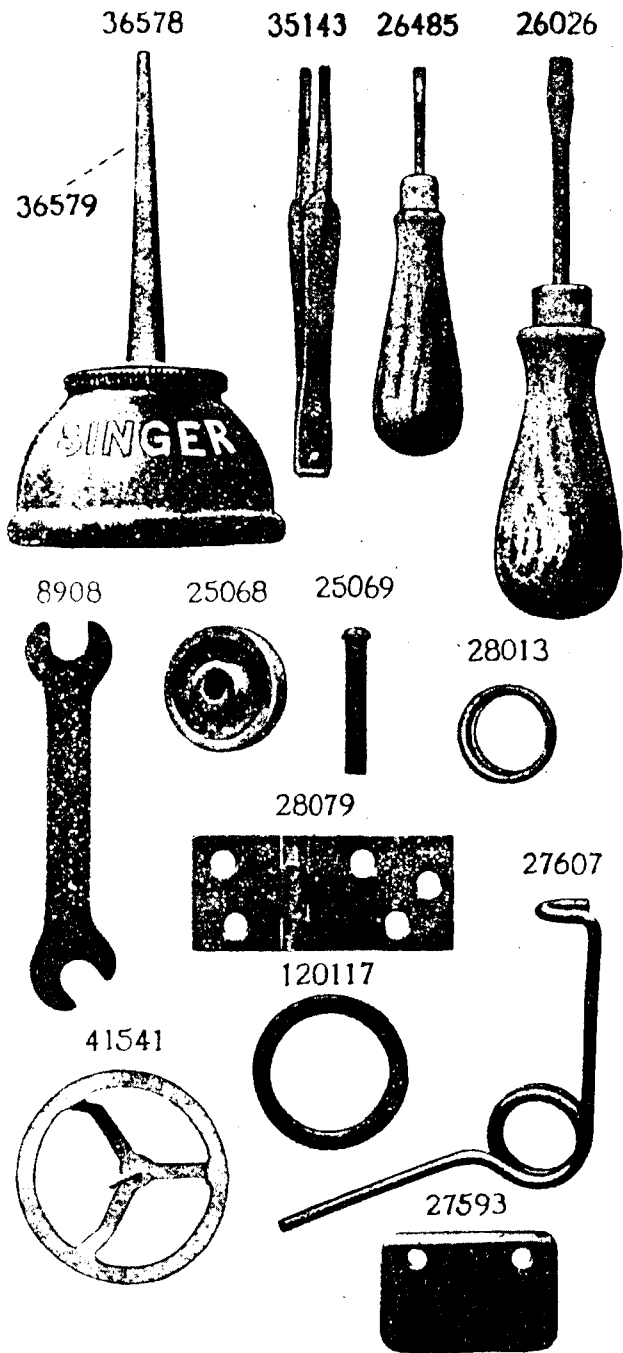

PLATE 6931—FULL SIZE

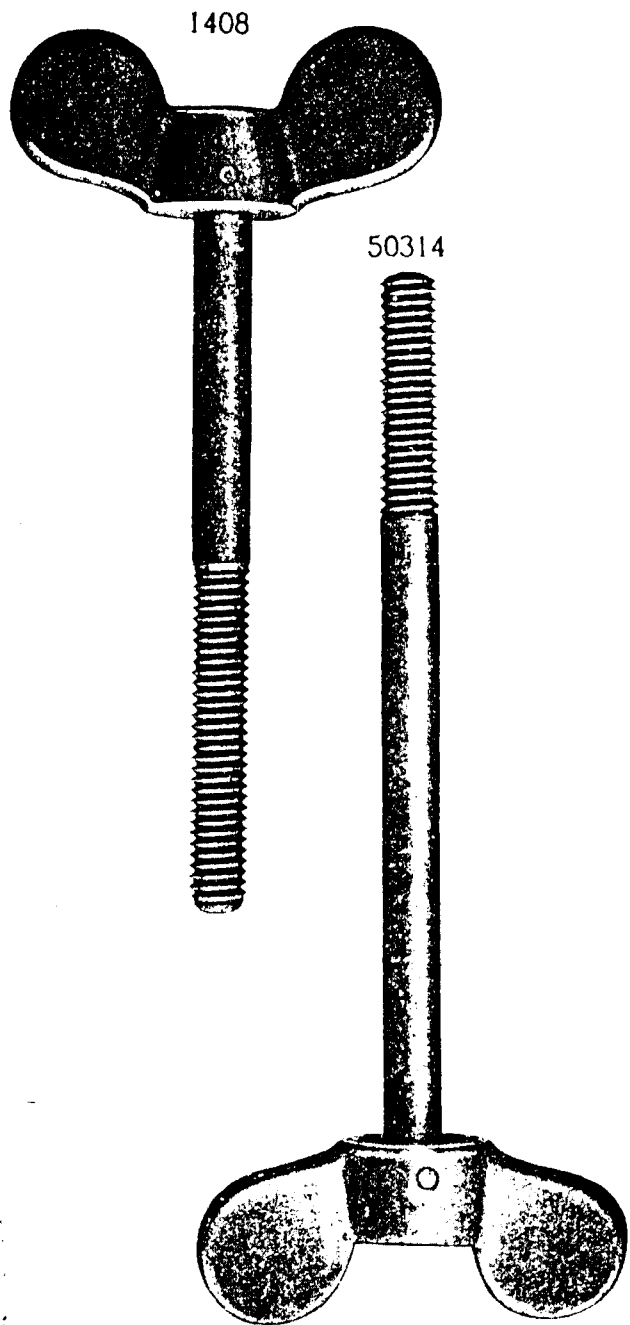

PLATE 6932—FULL SIZE

