

FORM 1952w  
MARCH, 1925  
PRINTED IN U. S. A.

**LIST**  
**OF**  
**PARTS**



**MACHINES**  
**Nos. 36-1 and 36-3**

---

**THE SINGER MANUFACTURING COMPANY**

COPYRIGHT, U. S. A., 1925,  
BY THE SINGER MANUFACTURING Co.  
ALL RIGHTS RESERVED FOR ALL COUNTRIES

## INDEX

---

	PAGE
ACCESSORIES .....	17
BINDER .....	20
MACHINE No. 36-1 .....	7
"    "    36-3 .....	12
NUMERICAL LIST OF PARTS .....	29
OBSOLETE PARTS .....	28
TRACK PARTS .....	21

## INSTRUCTIONS FOR ORDERING

In ordering from this list, use **ONLY** the PART number in the **FIRST** column.

The number stamped on a Sewing Machine part is in every case the number of the single part only.

Every combination of parts sent out as such has its specific number, which, although not stamped on the parts, must be used when ordering the combination.

Each number always indicates the **SAME PART** in whatever list it appears, or for whatever machine.

The letters after some of the numbers indicate the style of finish only, as follows:

- A. Hardened, Polished and Plated.
- B. Polished and Plated.
- C. Hardened only.
- D. Polished only.
- E. Soft, not Polished.
- F. Hardened and Polished.
- G.
- H. Blued.
- J. Plated only.
- K. Hardened and Plated.
- L. Brass or Gilt.
- M. Oxidized.
- P. Japanned.
- R. Parkerized.
- T. Copper-plated.

These letters **MUST BE USED** when they appear in the list, and **AFTER** the number as in the list.

In this series:

- 1 to 1500 and 50001 to 51500 are Screw Numbers.
- 1501 to 1800 are Nut Numbers.
- 1801 to 2000 are Roller Numbers.
- 2001 to 50000 and 52001 and upward are numbers of Machine Parts.

The figures in the second column refer only to the plates, illustrating the parts, and are **NOT TO BE USED** in ordering.

Parts marked with an asterisk (\*) are furnished only when repairs are made at factory.

## LIST OF PARTS COMPLETE

FOR

## MACHINE No. 36-1

POSITIVE FEED. FOR POWER. ON TRACK

For Seaming Light and Medium Weight  
Carpets and Rugs

No.	Plate	Name
12501	1053	Driving Belt Roller (2) .....
191c	1058	" " " Screw (2) .....
8800	1072	" " " Washer (2)
12502	1053	" " " Support (left) with two 453c .....
12776	1053	Driving Belt Roller Support (right) with two 453c .....
453c	1058	Driving Belt Roller Support Set Screw .....
12503	1053	Driving Wheel .....
12504	---	Driving Wheel complete, Nos. 491c, 12503, 12514, 12515, 12517, 12518, 12759 and two 12516 .....
12505	1052	Feed Disengaging Lever with 791c ..
12506	1057	" " " Hinge Pin ..
12507	1057	" " " Locking Pin
10195	1057	" " " " "
		Spring .....
12508	1055	Feed Eccentric with 465c .....
12509	1057	" " Pin .....
465c	1058	" " Set Screw .....
12675	1052	" Guide .....
12676	1052	" " Stud (eccentric) .....
914c	1081	" " " Set Screw .....
12510	1052	" Lever .....
729c	1059	" " Screw .....
12511	1056	" " Slide Block .....
12512	1056	" Point .....
791c	1058	" " Set Screw .....
*12513	---	Frame .....
12514	1053	Friction Wheel with 1143c .....
12515	1056	" " " Gib .....
12516	1057	" " " Position Pin .....
12517	1056	" " " Latch with 12519 ..
12759	1057	" " " Spring .....

## Parts for Machine No. 36-1

No.	Plate	Name
12518	1056	Friction Wheel Latch Washer .....
12519	1057	" " " " Pin ..
401E	1058	" " " " Screw ..
3012	1057	" " Pin .....
1143c	1086	" " Set Screw .....
12520	1054	Grip Lever .....
12521	1056	" " Lock .....
12522	1055	" " Bracket .....
172c	1058	" " " " Screw .....
208D	1058	" " " Clamping Screw ..
50252F	1081	" " " Regulating Screw ..
89c	1059	" " " Screw .....
12523	1057	" " " Spring .....
12524	1057	" " " Hook .....
248A	1058	" " Set Screw .....
12689	1057	" " Spring .....
12525	1057	" " Hook, for 12689 ..
12526	1057	" " " " " 12523 ..
12843	1082	Guide Holder Body .....
12844	1082	" " Plate .....
1149c	1081	" " " Screw .....
134c	1058	" " " Screw .....
12845	---	Guide Holder complete, Nos. 212E, 1149c, 12843 and 12844 .....
212F	1081	Guide Stop Screw .....
12536	1052	Hand Wheel .....
960B	1058	" " Screw (2) .....
12537	1055	Locking Cam with 465c .....
12538	1057	" " Pin .....
465c	1058	" " Set Screw .....
12539	1052	" Lever with 791c .....
12540	1056	" " Shaft Slide Block .....
12541	1056	" " Slide Block .....
12542	1056	" Point .....
791c	1058	" " Set Screw .....
12543	1056	Looper .....
*12544	---	" Bracket .....
146D	1058	" " Screw (2) .....
8554	1081	" " Steady Pin (2) .....
12545	1055	" Cam with 465c .....
12546	1057	" " Pin .....
465c	1058	" " Set Screw .....
12547	1053	" Lever with 193F .....
12548	1055	" " Strap .....
12549	1056	" " " Division Block (2)
50252F	1081	" " " " " Screw
		(2) .....
12550	1057	Looper Position Point .....
233D	1058	" " " Screw .....

## Parts for Machine No. 36-1

No.	Plate	Name
193F	1058	Looper Set Screw .....
12750	1054	" Thread Cone Center (wood) ..
12756	1054	" " Spool Bracket .....
161D	1058	" " " " Screw .....
12751	1054	" " " Clamping Disc ..
12871	1082	" " " Post, 5 1/2 in. long ..
1519E	1061	" " " " Nut .....
12749	1054	" " " Rest Disc .....
12557	1053	" " Tension Bracket .....
2269	1057	" " " " Position
		Pin .....
191c	1058	Looper Thread Tension Bracket
		Screw .....
2102	1056	Looper Thread Tension Disc (2) ..
1560c	1061	" " " Regulating
		Thumb Nut .....
2103	1057	Looper Thread Tension Spring .....
956c	1061	" " " Stud .....
1547D	1061	" " " Lock Nut
12558	1052	Needle Cam with 445c .....
3012	1057	" " Pin .....
445c	1058	" " Set Screw .....
200F	1058	" Clamping Screw .....
12560	1056	" Guide .....
176F	1058	" " Screw .....
12900	1082	" Slide .....
12562	1052	" " Bar .....
447c	1058	" " Set Screw .....
12564	1056	" " Gib .....
12565	1057	" " " Pin .....
1876	1058	" " Roller and Screw Stud ..
12750	1054	" Thread Cone Center (wood) ..
12566	1057	" " Guide .....
12757	1054	" " Spool Bracket .....
161D	1058	" " " " Screw .....
12751	1054	" " " Clamping Disc ..
12871	1082	" " " Post, 5 1/2 in. long ..
1519E	1061	" " " " Nut .....
12749	1054	" " " Rest Disc .....
12568	1056	" " Take-up Block .....
792D	1058	" " " " Screw .....
12569	1056	" " " Eyelet .....
402D	1058	" " " " Screw .....
2102	1056	" " Tension Disc (2) .....
1560c	1061	" " " Regulating Thumb
		Nut .....
2103	1057	Needle Thread Tension Spring .....
956c	1061	" " " Stud .....

No.	Plate	Name
12570	1052	Piler .....
703b	1059	" Thumb Screw .....
12571	1055	Pull-off .....
190b	1058	" Screw .....
12572	1055	Return Belt Roller .....
45c	1059	" " " Screw .....
12573	1053	Roller (lower) (2) .....
12575	1053	" " Stud (left) .....
12574	1053	" " " (right) .....
191c	1058	" " " Screw .....
8800	1072	" " " Washer .....
448c	1058	" " " Set Screw (2) .....
12576	1055	Safety Catch .....
12577	1055	" " Bracket .....
200f	1058	" " " Screw .....
12578	1057	" " Hinge Pin .....
12580	1052	Shaft .....
12581	1056	Spreader .....
12582	1055	" Cam with 465c .....
12546	1057	" " Pin .....
465c	1058	" " Set Screw .....
12584	1053	" Lever .....
181b	1058	" Screw .....
12585	1052	Starting Lever .....
2022	1081	" " Pin .....
12586	1056	" " Trip .....
12587	1057	" " Hinge Pin .....
12588	1057	" " " Spring .....
12866	1082	Stop Lever .....
12590	1056	" " Friction Pad (rawhide) .....
335d	1058	" " " " Screw (2) .....
1331c	1081	" " Hinge Screw .....
1611e	1081	" " " " Nut .....
202f	1058	" " Regulating Screw .....
12592	1052	" " Spring .....
12872	1081	" " " Support Pin .....
12594	1055	Tripping Lever .....
12595	1055	" " Finger .....
12596	1057	" " " Hinge Pin .....
12597	1057	" " " Spring .....
236b	1058	" " " " Screw .....
826f	1059	" " Screw .....
12598	1057	" " Spring .....
193f	1058	" " Stop Screw .....
12599	1054	Yielding Fork (left) .....
12678	1054	" " " Roller .....
12603	1054	" " " " Stud .....

No.	Plate	Name
12677	1054	Yielding Fork (right) .....
12601	1054	" " " Roller .....
12680	1054	" " " " Spring .....
12679	1054	" " " " Stud .....
191c	1058	" " " " " Screw .....
8800	1072	" " " " " Washer .....
12602	1054	Yielding Fork Spring (2) .....

## LIST OF PARTS COMPLETE

FOR

### MACHINE No. 36-3

POSITIVE FEED. FOR POWER. ON TRACK

For Seaming Medium and Heavy Weight  
Carpets and Rugs

No.	Plate	Name
12501	1053	Driving Belt Roller (2) .....
191c	1058	"    "    "    "    Screw (2) .....
8800	1072	"    "    "    "    Washer (2)
12502	1053	"    "    "    "    Support (left) with two 453c .....
12776	1053	Driving Belt Roller Support (right) with two 453c .....
453c	1058	Driving Belt Roller Support Set Screw .....
12503	1053	Driving Wheel .....
12504	—	Driving Wheel complete, Nos. 401E, 12503, 12514, 12515, 12517, 12518, 12759 and two 12516 .....
12505	1052	Feed Disengaging Lever with 791c ..
12506	1057	"    "    "    "    Hinge Pin ..
12507	1057	"    "    "    "    Locking Pin
10195	1057	"    "    "    "    "    " Spring .....
12508	1055	Feed Eccentric with 465c .....
12509	1057	"    "    Pin .....
465c	1058	"    "    Set Screw .....
12675	1052	"    Guide .....
12895	1081	"    "    Stud (eccentric) .....
1229c	1081	"    "    Set Screw .....
12510	1052	"    Lever .....
729c	1059	"    "    Screw .....
12511	1056	"    "    Slide Block .....
12512	1056	"    Point .....
791c	1058	"    "    Set Screw .....
*12896	—	Frame .....
12514	1053	Friction Wheel with 1143c .....
12515	1056	"    "    Gib .....
12516	1057	"    "    Position Pin ...
12517	1056	"    "    Latch with 12519 ...

No.	Plate	Name
12759	1057	Friction Wheel Latch Spring .....
12518	1056	"    "    "    "    Washer .....
12519	1057	"    "    "    "    Pin ....
401E	1058	"    "    "    "    Screw ..
3012	1057	"    "    Pin .....
1143c	4086	"    "    Set Screw .....
12520	1054	Grip Lever .....
12521	1056	"    "    Lock .....
12522	1055	"    "    "    Bracket .....
172c	1058	"    "    "    Screw .....
208D	1058	"    "    "    Clamping Screw ..
50252E	1081	"    "    "    Regulating Screw..
89c	1059	"    "    "    Screw .....
12523	1057	"    "    "    Spring .....
12524	1057	"    "    "    "    Hook .....
248A	1058	"    "    Set Screw .....
12689	1057	"    "    Spring .....
12525	1057	"    "    "    Hook, for 12689 ..
12526	1057	"    "    "    "    "    12523 ..
12847	1082	Guide Holder Body .....
12844	1082	"    "    Plate .....
1149c	1081	"    "    "    Screw .....
134c	1058	"    "    Screw .....
12848	—	Guide Holder complete, Nos. 212E, 1149c, 12844 and 12847 .....
212E	1081	Guide Stop Screw .....
12536	1052	Hand Wheel .....
960B	1058	"    "    Screw (2) .....
12537	1055	Locking Cam with 465c .....
12538	1057	"    "    Pin .....
465c	1058	"    "    Set Screw .....
12539	1052	"    Lever with 791c .....
12540	1056	"    "    Shaft Slide Block .....
12541	1056	"    "    Slide Block .....
12542	1056	"    Point .....
791c	1058	"    "    Set Screw .....
12543	1056	Looper .....
*12849	—	"    Bracket .....
146D	1058	"    "    Screw (2) .....
8554	1081	"    "    Steady Pin (2) .....
12545	1055	"    Cam with 465c .....
12546	1057	"    "    Pin .....
465c	1058	"    "    Set Screw .....
12850	1082	"    Lever with 193F .....
12870	1081	"    "    Strap .....
12549	1056	"    "    "    Division Block (2)
50252E	1081	"    "    "    "    "    Screw (2) .....
12550	1057	Looper Position Point .....
233D	1058	"    "    "    Screw .....

No.	Plate	Name
193F	1058	Looper Set Screw .....
12750	1054	" Thread Cone Center (wood) ..
12756	1054	" " Spool Bracket .....
161D	1058	" " " " Screw .....
12751	1054	" " " Clamping Disc ..
12871	1082	" " " Post, 5 1/4 in. long ..
1519E	1061	" " " " Nut .....
12749	1054	" " " Rest Disc .....
12557	1053	" " Tension Bracket .....
2269	1057	" " " " Position Pin .....
191C	1058	Looper Thread Tension Bracket Screw .....
2102	1056	Looper Thread Tension Disc (2) ..
1560C	1061	" " " " Regulating Thumb Nut .....
2103	1057	Looper Thread Tension Spring .....
956C	1061	" " " " Stud .....
1547J	1061	" " " " Lock Nut .....
12851	1082	Needle Cam with 445C .....
3012	1057	" " Pin .....
445C	1058	" " Set Screw .....
200F	1058	" Clamping Screw .....
12852	1081	" Guide .....
176F	1058	" " Screw .....
12897	1082	" Slide .....
12562	1052	" " Bar .....
447C	1058	" " " Set Screw .....
12869	1081	" " Gib .....
12565	1057	" " " Pin .....
12898	1082	" " Guide Block .....
743C	1081	" " " " Position Screw .....
12899	1081	Needle Slide Guide Block Stud .....
200D	1058	" " " " " " Set Screw .....
1966	1081	Needle Slide Roller and Screw Stud ..
12750	1054	" Thread Cone Center (wood) ..
12566	1057	" " Guide .....
12757	1054	" " Spool Bracket .....
161D	1058	" " " " Screw .....
12751	1054	" " " Clamping Disc ..
12871	1082	" " " Post, 5 1/4 in. long ..
1519E	1061	" " " " Nut .....
12749	1054	" " " Rest Disc .....
12854	1081	" " Take-up Block .....
792D	1058	" " " " Screw .....
12569	1056	" " " Eyelet .....
402D	1058	" " " " Screw .....
2102	1056	" " Tension Disc (2) .....

No.	Plate	Name
1560C	1061	Needle Thread Tension Regulating Thumb Nut .....
2103	1057	Needle Thread Tension Spring .....
956C	1061	" " " " Stud .....
12855	1082	Piler .....
199D	1081	" Cap Screw .....
12857	1081	" Connecting Rod .....
12902	1086	" " " Guide .....
38C	1081	" " " Hinge Screw (lower) .....
1330C	1081	Piler Connecting Rod Hinge Screw (upper) .....
12571	1055	Pull-off .....
190D	1058	" Screw .....
12572	1055	Return Belt Roller .....
45C	1059	" " " " Screw .....
12573	1053	Roller (lower) (2) .....
12575	1053	" " Stud (left) .....
12858	1081	" " " (right) .....
1677C	1081	" " " " Nut .....
1513E	1081	" " " " Lock Nut .....
448C	1058	" " " Set Screw (2) .....
12576	1055	Safety Catch .....
12577	1055	" " Bracket .....
200F	1058	" " " Screw .....
12578	1057	" " Hinge Pin .....
12894	---	Shaft .....
12859	1083	Spreader .....
12582	1055	" Cam with 465C .....
12546	1057	" " Pin .....
465C	1058	" " Set Screw .....
12860	1083	" Connecting Rod (rack) .....
12861	1083	" " " Plate .....
207F	1083	" " " " Screw ..
176F	1058	" " " " Screw .....
7071	1083	" " " " Washer .....
12862	1082	" Lever .....
12863	1083	" " Cap .....
185H	1083	" " " Screw (2) .....
12864	1083	" Pinion .....
12865	1083	" " Cover .....
229D	1058	" " " Screw (2) .....
2269	1057	" " Pin .....
12585	1052	Starting Lever .....
2022	1081	" " Pin .....
12586	1056	" " Trip .....
12587	1057	" " " Hinge Pin .....
12588	1057	" " " Spring .....

No.	Plate	Name
12866	1082	Stop Lever .....
12590	1056	" " Friction Pad (rawhide) .....
335D	1058	" " " " Screw (2) .....
1331c	1081	" " Hinge Screw .....
1611E	1081	" " " " Nut .....
202F	1058	" " Regulating Screw .....
12592	1052	" " Spring .....
12867	1083	" " " " Support Pin .....
12594	1055	Tripping Lever .....
12595	1055	" " Finger .....
12596	1057	" " " " Hinge Pin .....
12597	1057	" " " " Spring .....
236D	1058	" " " " Screw .....
826F	1059	" " Screw .....
12598	1057	" " Spring .....
193F	1058	" " Stop Screw .....
12599	1054	Yielding Fork .....
12678	1054	" " " " Roller .....
12603	1054	" " " " Stud .....
12677	1054	" " (right) .....
12601	1054	" " " " Roller .....
12680	1054	" " " " Spring .....
12679	1054	" " " " Stud .....
191c	1058	" " " " " " Screw .....
8800	1072	" " " " " " " " .....
		Washer .....
12602	1054	Yielding Fork Spring (2) .....

## ACCESSORIES

### FOR MACHINE No. 36-1

No.	Plate	Name
12774	1057	Gauge, for 12512 and 12542 .....
12527	1062	Guide, to sew Brussels .....
12528	1062	" " " Moquette, Velvet and Axminster .....
12529	1062	Guide, to sew serged edge and border on Brussels .....
12530	1062	Guide, to sew American Axminster .....
12532	1062	" " " Tapestry .....
12533	1062	" " " Wilton .....
12746	1062	" " " Imperial Axminster and heavy Wilton .....
12748	1063	Guide, to sew extra thick serged edge .....
12755	1063	Guide, to sew Brussels (turned edge) .....
12688	1062	" " " Ingrain .....
12803	1063	" " " Matting .....
12804	1062	" " " Moquette (turned edge) .....
12543	1056	Looper .....
36 x 5	-	Needles, five, size 25 .....
120346	1084	Oiler (copper plated) with 120347 .....
120347	1084	" Spout, 9 in. long .....
12747	1052	Piler, to be used only with 12746 .....
12833	1052	" " " " " " 12804 .....
26346	1084	Pliers (4 in. flat nose) .....
11831	1084	Screw Driver (large) .....
*120091	.....	" " Blade .....
*120090	.....	" " Handle .....
26151	1084	Screw Driver, Nos. 120090 and 120091 .....
120341	1084	Tweezers (curved) .....

### FOR MACHINE No. 36-3

Same as 36-1 with the following exceptions:

12802	1063	Guide, to sew Matting .....
12868	1085	" " " Brussels .....
12874	1085	" " " Moquette (flat seam) .....
12873	1085	" " " Nap Axminster (coarse) .....
12875	1085	Guide, to sew Nap Axminster (coarse) .....



## Accessories

No.	Plate	Name
12876	1085	Guide, to sew Wilton (for taking the fullness) .....
36 x 3	—	Needles, five, size 26 .....
12877	1085	Piler, to be used only with 12873 .....
12856	1085	" " " " " " 12804 .....

## GUIDES

## FOR MACHINE No. 36-1

12530	1062	Guide, to sew American Axminster ..
12527	1062	" " " Brussels .....
12755	1063	" " " " (turned edge) ..
12748	1063	" " " extra thick serged edge ..
12688	1062	" " " Ingrain .....
12790	1063	" " " Matting .....
12791	1063	" " " " .....
12792	1063	" " " " .....
12793	1063	" " " " .....
12803	1063	" " " " .....
12814	1064	" " " " .....
12815	1064	" " " " .....
12804	1064	" " " Moquette (turned edge) ..
12528	1062	" " " " Velvet and Axminster .....
12529	1062	Guide, to sew serged edge and border on Brussels .....
12532	1062	Guide, to sew Tapestry .....
12533	1062	" " " Wilton .....
12746	1062	" " " Imperial Axminster and heavy Wilton .....

## FOR MACHINE No. 36-3

12530	1062	Guide, to sew American Axminster ..
12748	1063	" " " extra thick serged edge ..
12790	1063	" " " Matting .....
12803	1063	" " " " .....
12791	1063	" " " " .....
12868	1063	" " " " .....
12792	1063	" " " " .....
12793	1063	" " " " .....
12814	1064	" " " " .....
12815	1064	" " " " .....
12804	1064	" " " Moquette (turned edge) ..
12874	1064	" " " " (flat seam) ..
12532	1062	" " " Tapestry .....
12533	1062	" " " Wilton .....
12876	1085	" " " " (for taking the fullness) .....

## Accessories

No.	Plate	Name
12873	1085	Guide, to sew Nap Axminster (coarse) .....
12875	1085	Guide, to sew Nap Axminster (coarse) .....

## FURNISHED WITH TRACK

8978	1084	Belt Awl .....
12669	1076	" Compressor Bracket .....
12670	1076	" " Lever .....
12671	1071	" " " Hinge Pin .....
12668	1076	Belt Compressor complete, Nos. 12669 to 12671 and three wood screws 1 in., No. 10 .....
12763	1076	Clamp (stretching) Jaw (left) .....
12762	1076	" " " (right) .....
12761	1071	" " " Hinge Pin .....
12764	1076	" " Link .....
12765	1071	" " " Hinge Pin .....
12766	1071	" " Spring .....
12767	1071	" " " Hook, for 12762 .....
12768	1071	" " " " " 12763 .....
12672	—	" " Strap .....
12760	1076	" " " Eyelet .....
12761	1071	" " " " Hinge Pin .....
12769	1076	Clamp (stretching) complete, Nos. 12760, 12762, 12763, 12766 to 12768, two each 12761, 12764 and 12765 ..
12753	1084	Wrench, for 873E .....
19221	1084	" " 611D .....

**BINDER**

FOR MACHINE No. 36-1

No.	Plate	Name
*12816	1075	Binding Holder Base .....
402D	1058	" " " Screw .....
12817	1075	" " Bracket .....
*12818	1075	" " Rim .....
12819	1075	" " " Supporting Arm .....
236F	1058	" " " " " " Screw .....
172c	1058	Binding Holder Screw .....
12820	1075	Binding Holder complete, Nos. 172c, 236F, 401E, 812B, 1621F, 12816 to 12819, 12821, 12822, two 402D, and three 233D .....
12821	1075	Binding Tension Spring .....
12822	1075	" " " Bracket .....
233D	1058	" " " " " Screw (lower) .....
401E	1058	Binding Tension Spring Bracket Screw (upper) .....
812B	1061	Binding Tension Spring Regulating Screw .....
1621E	1061	Binding Tension Spring Regulating Screw Nut .....
233D	1058	Binding Tension Spring Screw .....
12823	—	Binder complete, Nos. 12820 and 12824 .....
12824	1075	Guide, for binding .....

Note: When ordering No. 12824 send sample of carpet and binding.

**TRACK**

SUPPORTED BY LEGS

No.	Plate	Name
12605	—	Belt .....
12690	1077	" Adjusting Bracket with two 795c .....
967E	1058	" " " Screw .....
12691	1079	" " Rod, length 3 ft. 7 inches .....
12692	1077	" " " Pulley, 6½ in. diameter .....
795c	1058	Belt Adjusting Rod Set Screw .....
12811	—	Belt Adjuster complete, Nos. 12690, 12700, 12719, 12720, two each 819c, 12691, 12692 and three 967E .....
12770	1072	Belt Coupling Joint Ball .....
12771	1072	" " " " Rivet .....
873E	1072	" " " " Screw .....
12772	—	Belt Coupling Joint complete, Nos. 12771, two each 873E and 12770 .....
12773	1072	Belt Coupling Sleeve .....
12610	1072	Belt Coupling complete, Nos. 12772, two each 12773 and wood screws ¾ in., No. 9 .....
12693	1078	Brace (long), 3 ft. 7 in. section .....
12878	—	" " 3 ft. section .....
12745	1078	" (short), 3 ft. 7 in. section .....
12879	—	" " 3 ft. section .....
12694	1078	" Angle (lower) .....
953J	1060	" " " Bolt, 2¼ x ½ in. with 1522J .....
1522J	1061	Brace Angle (lower) Bolt Nut .....
12620	1072	" " " " Washer .....
12695	1078	" " (upper) .....
954J	1060	" " " Bolt, 2¼ x ½ in. with 1522J .....
1522J	1061	Brace Angle (upper) Bolt Nut .....
12813	1072	" " " " Washer .....
954J	1060	" " Bolt, 2¼ x ½ in. with 1522J, for single brace .....
1522J	1061	Brace Angle Bolt Nut .....
12620	1072	" " " " Washer .....
783E	1058	" Screw .....
9281	1072	" " Washer .....
12696	1076	Carpet Height Guide .....
145E	1058	" " " " Screw .....
1528c	1061	" " " " " Nut .....

## Parts of Track

No.	Plate	Name
12697	1080	Clamping Arm with 12614 .....
12834	1071	" " Spring .....
12614	1057	" " Hook .....
12698	1073	" Jaw (inside) .....
138E	1058	" " " Screw .....
12699	1073	" " (outside) with 12617 ...
690D	1058	" " " Screw .....
12617	1086	" " Spur .....
12700	1076	Driving Belt Adjusting Bracket with 611D .....
611D	1058	Driving Belt Adjusting Bracket Ad- justing Screw .....
819C	1059	Driving Belt Adjusting Bracket Screw Stud .....
12705	1076	Feed Rack (end) .....
12706	1076	" " (intermediate), 3 ft. 7 in. section .....
12880	---	Feed Rack (intermediate), 3 ft. sec- tion .....
430C	1058	Feed Rack Adjusting Screw .....
1520J	1061	" " " Nut .....
445C	1058	" " Set Screw .....
12809	1080	Guide Rack (wood) with eleven name plates and twenty-two pins
938E	1059	Guide Rack Bolt, 3 x 1/4 in., with 1524E
1524E	1061	" " " Nut .....
210805	1086	" " " Washer .....
12707	1077	Hanger, for 12718, with 436C, 1517E, two each 430C, 445C and 1520J ..
12836	1080	Hanger, for 12718, with 12614, two each 430C, 445C and 1520J .....
821E	1060	Hanger Screw .....
12708	1077	" (intermediate) with two each 430C, 445C and 1520J .....
821E	1060	Hanger (intermediate) Screw .....
954J	1060	" Bolt, 2 1/4 x 1/2 in., with 1522J ..
1522J	1061	" " Nut .....
12620	1072	" " Washer .....
12709	1077	" Bracket .....
12837	1080	" " for 599E .....
12883	---	" " Stay Bar (intermediate), length 3 ft., for 3 ft. section .....
12691	1079	Hanger Bracket Stay Bar (interme- diate), length 3 ft. 7 in., for 3 ft. 7 in. section .....
12881	---	Hanger Bracket Stay Bar (end) (left), length 3 ft. 1 1/2 in., for 3 ft. section .....

## Parts of Track

No.	Plate	Name
12742	1079	Hanger Bracket Stay Bar (end) (left), length 3 ft. 8 1/2 in., for 3 ft. 7 in. section .....
12882	---	Hanger Bracket Stay Bar (end) (right), length 3 ft. 2 1/2 in., for 3 ft. section .....
12832	1079	Hanger Bracket Stay Bar (end) (right), length 3 ft. 9 1/2 in., for 3 ft. 7 in. section .....
12743	1076	Hanger Bracket Stay Bar Coupling with 795C .....
12744	1076	Hanger Bracket Stay Bar Coupling Bracket with 795C .....
954J	1060	Hanger Bracket Stay Bar Coupling Bracket Bolt with 1522J .....
1522J	1061	Hanger Bracket Stay Bar Coupling Bracket Bolt Nut .....
822E	1060	Hanger Bracket Stay Bar Coupling Screw .....
795C	1058	Hanger Bracket Stay Bar Set Screw
12714	1077	Hanging Arm with 448C .....
12715	1077	" " Latch with 12673 .....
25D	1059	" " " Hinge Screw ...
12673	1057	" " " Pin .....
9534	1071	" " " Spring .....
12716	1072	" " Spur .....
12717	1072	" " " Holder .....
12835	1072	" " " " 12717 with 12716 .....
448C	1058	Hanging Arm Spur Holder Screw ..
12718	1078	Leg .....
12812	1080	" Brace .....
497J	1060	" " Bolt, 1 1/2 x 1/2 in., with 1522J
1522J	1061	" " " Nut .....
12813	1072	" " " Washer .....
		" wood screw, for floor, 2 in., No. 24 .....
12719	1076	Name Plate with two 448C .....
448C	1058	" " Set Screw .....
12720	1076	Return Belt Adjusting Bracket with 611D .....
611D	1058	Return Belt Adjusting Bracket Ad- justing Screw .....
819C	1059	Return Belt Adjusting Bracket Screw Stud .....
12721	1077	Starting Lever with 795C .....
795C	1058	" " Set Screw .....
12722	1073	" " Trip Pawl .....
786D	1059	" " " Hinge Screw
12648	1072	" " " " Spring ...

## Parts of Track

No.	Plate	Name
236b	1058	Starting Lever Trip Pawl Spring Screw .....
12884	—	Starting Rod (end) (left), for 3 ft. section .....
12723	1079	Starting Rod (end) (left), for 3 ft. 7 in. section .....
12885	—	Starting Rod (end) (right), for 3 ft. section .....
12725	1079	Starting Rod (end) (right), for 3 ft. 7 in. section .....
12724	1073	Starting Rod (end) Collar with 363c
363c	1058	" " " " Set Screw
12886	—	" " (intermediate), for 3 ft. section .....
12726	1079	Starting Rod (intermediate), for 3 ft. 7 in. section .....
12727	1073	Starting Rod (intermediate) Collar with 363c
363c	1058	Starting Rod (intermediate) Collar Set Screw .....
12728	1076	Stop Bracket with 363, 12641 and two 190b .....
12641	1072	Stop Bracket Pad (rawhide) .....
190b	1058	" " " " Screw .....
12729	1076	" " (for return machine) .....
145E	1058	" " " " " " Screw
1528c	1061	" " " " " " Nut .....
12730	1071	Stop Bracket Pawl .....
12643	1071	" " " " Spring .....
236b	1058	" " " " " " Screw .....
784c	1058	" " " " " " Stud .....
12674	1071	" " " " " " Stop Pin .....
363c	1058	" " " " " " Set Screw .....
12731	1077	Stretching Arm with 429c, 453c, 795c and 1513j .....
12732	1077	Stretching Arm Lever .....
823c	1059	" " " " " " Hinge Screw
1608c	1061	" " " " " " Nut .....
12733	1073	Stretching Arm Lever Link .....
824c	1059	" " " " " " Screw .....
1608c	1061	" " " " " " Nut .....
51001c	1086	" " " " " " Hinge Screw (for first section) .....
825c	1059	Stretching Arm Lever Link Hinge Screw .....
1608c	1061	Stretching Arm Lever Link Hinge Screw Nut .....

## Parts of Track

No.	Plate	Name
795c	1058	Stretching Arm Set Screw .....
12734	1073	" " " " " " Clamp (inside) .....
12735	1073	" " " " " " Bracket with 453c .....
138E	1058	Stretching Clamp (inside) Bracket Screw .....
12738	1071	Stretching Clamp (inside) Hinge Pin
453c	1058	" " " " " " " " " " Set Screw .....
12806	1073	Stretching Clamp (inside) Spring ..
436c	1083	" " " " " " Stop Screw Stud .....
1517j	1086	Stretching Clamp (inside) Stop Screw Stud Nut .....
12736	1073	Stretching Clamp (outside) .....
12738	1071	" " " " " " Hinge Pin
453c	1058	" " " " " " " " " " Set Screw .....
12807	1073	Stretching Clamp (outside) Spring
159E	1058	" " " " " " Stop Screw
429c	1086	" " " " " " " " " " Stud .....
1513j	1081	Stretching Clamp (outside) Stop Screw Stud Nut .....
12808	1073	Stretching Clamp Shield .....
12754	1080	Tool Tray .....
599E	1059	" " " " Bolt, 2½ x ¼ in., with 1524E
1524E	1061	" " " " " " Nut .....
210805	1086	" " " " " " Washer .....
12888	—	Track Rod (end, upper) (left), length 4 ft., for 3 ft. section .....
12739	1079	Track Rod (end, upper) (left), length 4 ft. 7 in., for 3 ft. 7 in. section .....
12889	—	Track Rod (end, upper) (right), length 4 ft., for 3 ft. section .....
12825	1079	Track Rod (end, upper) (right), length 4 ft. 7 in., for 3 ft. 7 in. section .....
12890	—	Track Rod (intermediate) (lower), length 3 ft., for 3 ft. section .....
12891	—	Track Rod (intermediate) (lower), length 3 ft., for 12690, for 3 ft. section .....
12828	1079	Track Rod (intermediate) (lower), length 3 ft. 7 in., for 3 ft. 7 in. section .....
12829	1079	Track Rod (intermediate) (lower), length 3 ft. 7 in., for 12690, for 3 ft. 7 in. section .....

No.	Plate	Name
12892	—	Track Rod (intermediate) (upper), length 3 ft., for 3 ft. section .....
12893	—	Track Rod (intermediate) (upper), length 3 ft., for 12690, for 3 ft. section .....
12740	1079	Track Rod (intermediate) (upper), length 3 ft. 7 in., for 3 ft. 7 in. section .....
12826	1079	Track Rod (intermediate) (upper), length 3 ft. 7 in., for 12690, for 3 ft. 7 in. section .....
12887	—	Track Rod (end, lower) (left and right), length 4 ft., for 3 ft. section .....
12827	1079	Track Rod (end, lower) (left and right), length 4 ft. 7 in., for 3 ft. 7 in. section .....
967E	1058	Track Rod (lower) Screw .....
966E	1058	" " (upper) Screw, long .....
967E	1058	" " " " short .....

**REMOVABLE MACHINE STOP AND BELT  
SUPPORT PARTS**

12501	1053	Driving Belt Roller .....
12681	1071	" " " Stud .....
191C	1058	" " " " Screw .....
457C	1086	" " " " Set Screw .....
8800	1072	" " " " Washer .....
12682	1075	Stop Stud .....
12683	1076	" " Arm with two 457C .....
12684	1076	" " Bracket with two 445C .....
445C	1058	" " " " Screw .....
12685	1071	" " " Hinge Pin .....
12686	1076	" " Latch Bracket .....
180E	1058	" " " " Screw .....
11121	1071	" " " Pin .....
11122	1071	" " " " Head .....
2269	1057	" " " " " Pin .....
11124	1071	" " " " Spring .....
11120	—	Stop Stud Latch Pin complete, Nos. 2269, 11121, 11122 and 11124 .....
1606C	1061	Stop Stud Nut .....
12687	—	Stop complete, Nos. 191C, 1606C, 8800, 11120, 12681 to 12686, 12830, 12831, two each 180E and 12501 .....
12830	1079	Track Rod (lower), length 3 ft. 7 inches .....

No.	Plate	Name
967E	1058	Track Rod (lower) Screw .....
12831	1079	" " (upper), length 3 ft. 7 inches .....
966E	1058	Track Rod (upper) Screw .....

**POWER TRANSMITTER PARTS**

12778	1077	Frame with three 968C .....
968C	1058	" Set Screw .....
12779	1077	Gear with 445C and 888C .....
12780	1077	" Cover .....
145E	1058	" " Screw .....
888C	1058	" Position Screw .....
445C	1058	" Set Screw .....
12782	1077	Machine Driving Pulley, 8 in. diam., with 445C and 888C .....
888C	1058	Machine Driving Pulley Position Screw .....
445C	1058	Machine Driving Pulley Set Screw .....
12784	1075	" " " Shaft .....
12785	1075	" " " " Bushing (eccentric) .....
968C	1058	Machine Driving Pulley Shaft Bushing Set Screw .....
12786	1077	Machine Return Pulley, 6½ in. diam., with 445C and 888C .....
888C	1058	Machine Return Pulley Position Screw .....
445C	1058	Machine Return Pulley Set Screw .....
12787	1075	" " " Shaft .....
12838	1082	Pinion with 445C and 888C .....
888C	1058	" Position Screw .....
445C	1058	" Set Screw .....
12789	—	Transmitter complete, Nos. 12778 to 12780, 12782, 12784 to 12787, 12838 and three 145E .....

**COUNTER SHAFT PARTS**

12794	1077	Driving Belt Bracket with three 363C .....
12795	1075	" " " Shaft .....
202244	—	" " " " Oil Wick .....
12805	1079	" " " " Pulley, 8 in. diam. (grooved, tight) with 909C .....
12796	1079	Driving Belt Bracket Shaft Pulley, 8 in. diam. (grooved, loose) .....
12797	1078	Driving Belt Bracket Shaft Pulley, 8 in. diam. (flat), with 909C .....

## Parts of Track

No.	Plate	Name
12798	1078	Driving Belt Bracket Shaft Pulley, 9 in. diam. (flat), with 909c .....
12799	1078	Driving Belt Bracket Shaft Pulley, 10 in. diam. (flat), with 909c .....
12810	1078	Driving Belt Bracket Shaft Pulley, 11 in. diam. (flat), with 909c .....
12800	1078	Driving Belt Bracket Shaft Pulley, 12 in. diam. (flat), with 909c .....
12903	-----	Driving Belt Bracket Shaft Pulley, 13 in. diam. (flat), with 909c .....
12904	-----	Driving Belt Bracket Shaft Pulley, 14 in. diam. (flat), with 909c .....
12905	-----	Driving Belt Bracket Shaft Pulley, 15 in. diam. (flat), with 909c .....
909c	1058	Driving Belt Bracket Shaft Pulley Set Screw .....
524c	1058	Driving Belt Bracket Shaft Screw
14044	1072	" " " " " Washer .....
363c	1058	Driving Belt Bracket Set Screw ...
12801	-----	Counter Shaft complete, Nos. 524c, 12794 to 12796, 12805, 12810, 14044 and one length of belting 10 ft. by 1½ in., with two hooks .....

**OBsolete PARTS**

12535	1053	Guide Holder Lock Catch, for Ma- chine No. 36-1 .....
12561	1052	Needle Slide, for Machine No. 36-1
12788	1075	Power Transmitter Pinion with 445c and 888c .....
12589	1052	Stop Lever, for Machine No. 36-1 ...
12591	1057	" " Hinge Pin, for Machine No. 36-1 .....
2049	1071	Driving Belt Roller Stud Pin .....

**NUMERICAL LIST OF PARTS**  
**FOR**  
**MACHINES**  
**Nos. 36-1 and 36-3**

## NUMERICAL LIST OF PARTS

No.	Plate	Name
25d	1059	Hanging Arm Latch Hinge Screw...
38c	1081	Piler Connecting Rod Hinge Screw (lower), for Machine No. 36-3 ...
45c	1059	Return Belt Roller Screw .....
89c	1059	Grip Lever Lock Screw .....
134c	1058	Guide Holder Screw .....
138E	1058	Clamping Jaw (inside) Screw .....
138E	1058	Stretching Clamp (inside) Bracket Screw .....
145E	1058	Carpet Height Guide Screw .....
145E	1058	Power Transmitter Gear Cover Screw, for 12789 .....
145E	1058	Stop Bracket (for return machine) Screw .....
146d	1058	Looper Bracket Screw .....
159E	1058	Stretching Clamp (outside) Stop Screw .....
161d	1058	Looper Thread Spool Bracket Screw
161d	1058	Needle Thread Spool Bracket Screw
172c	1058	Binding Holder Screw, for 12820 ..
172c	1058	Grip Lever Lock Bracket Screw ...
176F	1058	Needle Guide Screw .....
176F	1058	Spreader Connecting Rod Screw, for Machine No. 36-3 .....
180E	1058	Stop Stud Latch Bracket Screw, for 12687 .....
181d	1058	Spreader Screw, for Machine No. 36-1 .....
185h	1083	Spreader Lever Cap Screw, for Ma- chine No. 36-3 .....
190d	1058	Pull-off Screw .....
190d	1058	Stop Bracket Pad Screw, for 12728
191c	1058	Driving Belt Roller Screw .....
191c	1058	" " " Stud Screw, for 12687 .....
191c	1058	Looper Thread Tension Bracket Screw .....
191c	1058	Roller (lower) Stud Screw, for Ma- chine No. 36-1 .....
191c	1058	Yielding Fork (right) Roller Stud Screw .....
193F	1058	Looper Set Screw, for 12547 and 12850 .....
193F	1058	Tripping Lever Stop Screw .....

No.	Plate	Name
199D	1081	Piler Cap Screw, for Machine No. 36-3 .....
200F	1058	Needle Clamping Screw .....
200D	1058	" Slide Guide Block Stud Set Screw, for Machine No. 36-3 .....
200F	1058	Safety Catch Bracket Screw .....
202F	1058	Stop Lever Regulating Screw .....
207F	1083	Spreader Connecting Rod Plate Screw, for Machine No. 36-3 .....
208D	1058	Grip Lever Lock Clamping Screw ..
212F	1081	Guide Stop Screw, for 12845 and 12848 .....
229D	1058	Spreader Pinion Cover Screw, for Machine No. 36-3 .....
233D	1058	Binding Tension Spring Bracket Screw (lower), for 12820 .....
233D	1058	Binding Tension Spring Screw, for 12820 .....
233D	1058	Looper Position Point Screw .....
236F	1058	Binding Holder Rim Supporting Arm Screw, for 12820 .....
236D	1058	Starting Lever Trip Pawl Spring Screw .....
236D	1058	Stop Bracket Pawl Spring Screw ..
236D	1058	Tripping Lever Finger Spring Screw
248A	1058	Grip Lever Set Screw .....
335D	1058	Stop Lever Friction Pad Screw ...
363C	1058	Counter Shaft Driving Belt Bracket Set Screw, for 12794 .....
363C	1058	Starting Rod (end) Collar Set Screw, for 12724 .....
363C	1058	Starting Rod (intermediate) Collar Set Screw, for 12727 .....
363C	1058	Stop Bracket Set Screw, for 12728..
401E	1058	Binding Tension Spring Bracket Screw (upper), for 12820 .....
401E	1058	Friction Wheel Latch Washer Screw, for 12504 .....
402D	1058	Binding Holder Base Screw, for 12820 .....
402D	1058	Needle Thread Take-up Eyelet Screw
429C	1086	Stretching Clamp (outside) Stop Screw Stud, for 12731 .....
430C	1058	Feed Rack Adjusting Screw, for 12707, 12708 and 12836 .....
436C	1083	Stretching Clamp (inside) Stop Screw Stud, for 12707 .....
445C	1058	Feed Rack Set Screw, for 12707, 12708 and 12836 .....

No.	Plate	Name
445C	1058	Needle Cam Set Screw, for 12558 and 12851 .....
445C	1058	Power Transmitter Gear Set Screw, for 12779 .....
445C	1058	Power Transmitter Machine Driving Pulley Set Screw, for 12782 .....
445C	1058	Power Transmitter Machine Return Pulley Set Screw, for 12786 .....
445C	1058	Power Transmitter Pinion Set Screw, for 12788 and 12838 .....
445C	1058	Stop Stud Arm Bracket Screw, for 12684 .....
447C	1058	Needle Slide Bar Set Screw .....
448C	1058	Hanging Arm Spur Holder Set Screw, for 12714 .....
448C	1058	Name Plate Set Screw, for 12719 ..
448C	1058	Roller (lower) Stud Set Screw ....
453C	1058	Driving Belt Roller Support Set Screw, for 12502 and 12776 .....
453C	1058	Stretching Clamp (inside) Hinge Pin Set Screw, for 12735 .....
453C	1058	Stretching Clamp (outside) Hinge Pin Set Screw, for 12731 .....
457C	1086	Driving Belt Roller Stud Set Screw, for 12683 .....
465C	1058	Feed Eccentric Set Screw, for 12508
465C	1058	Locking Cam Set Screw, for 12537..
465C	1058	Looper Cam Set Screw, for 12545 ..
465C	1058	Spreader Cam Set Screw, for 12582
497J	1060	Leg Brace Bolt, 1½ x ½ in., with 1522J
524C	1058	Counter Shaft Driving Belt Bracket Shaft Screw, for 12801 .....
599E	1059	Tool Tray Bolt, 2½ x ½ in., with 1524E
611D	1058	Driving Belt Adjusting Bracket Adjusting Screw, for 12700 .....
611D	1058	Return Belt Adjusting Bracket Adjusting Screw, for 12720 .....
690D	1058	Clamping Jaw (outside) Screw ....
703D	1059	Piler Thumb Screw, for Machine No. 36-1 .....
729C	1059	Feed Lever Screw .....
743C	1081	Needle Slide Guide Block Position Screw, for Machine No. 36-3 .....
783E	1058	Brace Screw .....
784C	1058	Stop Bracket Pawl Spring Screw Stud .....
786D	1059	Starting Lever Trip Pawl Hinge Screw .....
791C	1058	Feed Point Set Screw, for 12505 ...
791C	1058	Locking Point Set Screw, for 12539



## Numerical List of Parts

No.	Plate	Name
792D	1058	Needle Thread Take-up Block Screw
795C	1058	Belt Adjusting Rod Set Screw, for 12690 .....
795C	1058	Hanger Bracket Stay Bar Set Screw, for 12743 and 12744 .....
795C	1058	Starting Lever Set Screw, for 12721
795C	1058	Stretching Arm Set Screw, for 12731
812B	1061	Binding Tension Spring Regulating Screw, for 12820 .....
819C	1059	Driving Belt Adjusting Bracket Screw Stud, for 12811, .....
819C	1059	Return Belt Adjusting Bracket Screw Stud, for 12811 .....
821E	1060	Hanger (intermediate) Screw .....
821E	1060	" Screw .....
822E	1060	" Bracket Stay Bar Coupling Screw .....
823C	1059	Stretching Arm Lever Hinge Screw
824C	1059	" " " Link Screw ..
825C	1059	" " " " Hinge Screw .....
826E	1059	Tripping Lever Screw .....
873E	1072	Belt Coupling Joint Screw, for 12772
888C	1058	Power Transmitter Gear Position Screw, for 12779 .....
888C	1058	Power Transmitter Machine Driving Pulley Position Screw, for 12782..
888C	1058	Power Transmitter Machine Return Pulley Position Screw, for 12786..
888C	1058	Power Transmitter Pinion Position Screw, for 12788 and 12838 .....
909C	1058	Counter Shaft Driving Belt Bracket Shaft Pulley Set Screw, for 12797 to 12800, 12805, 12810 and 12903 to 12905 .....
914E	1081	Feed Guide Stud Set Screw, for Machine No. 36-1 .....
938E	1059	Guide Rack Bolt, 3 x 1/4 in., with 1524E
953J	1060	Brace Angle (lower) Bolt, 2 3/4 x 1/2 in., with 1522J .....
954J	1060	Brace Angle (upper) Bolt, 2 1/4 x 1/2 in., with 1522J .....
954J	1060	Brace Angle Bolt, 2 1/4 x 1/2 in., with 1522J, for single Brace .....
954J	1060	Hanger Bolt, 2 1/4 x 1/2 in., with 1522J
954J	1060	" Bracket Stay Bar Coupling Bracket Bolt, 2 1/4 x 1/2 in., with 1522J
956C	1061	Looper Thread Tension Stud .....
956C	1061	Needle Thread Tension Stud .....
960B	1058	Hand Wheel Screw .....

## Numerical List of Parts

No.	Plate	Name
966E	1058	Track Rod (upper) Screw .....
966E	1058	" " " " (long) ..
967E	1058	Belt Adjusting Bracket Screw .....
967E	1058	Track Rod (lower) Screw .....
967E	1058	" " (upper) Screw (short)..
968C	1058	Power Transmitter Frame Set Screw, for 12778 .....
968C	1058	Power Transmitter Machine Driving Pulley Shaft Bushing Set Screw..
1143C	1086	Friction Wheel Set Screw, for 12514
1149C	1081	Guide Holder Plate Screw, for 12845 and 12848 .....
1229C	1081	Feed Guide Stud Set Screw, for Machine No. 36-3 .....
1330C	1081	Piler Connecting Rod Hinge Screw (upper), for Machine No. 36-3 ..
1331C	1081	Stop Lever Hinge Screw .....
1513E	1081	Roller (lower) Stud (right) Nut Lock Nut, for Machine No. 36-3 ..
1513J	1081	Stretching Clamp (outside) Stop Screw Stud Nut, for 12731 .....
1517J	1086	Stretching Clamp (inside) Stop Screw Stud Nut, for 12707 .....
1519E	1061	Looper Thread Spool Post Nut ....
1519E	1061	Needle Thread Spool Post Nut ...
1520J	1061	Feed Rack Adjusting Screw Nut, for 12707, 12708 and 12836 .....
1522J	1061	Brace Angle (lower) Bolt Nut, for 953J .....
1522J	1061	Brace Angle (upper) Bolt Nut, for 954J .....
1522J	1061	Brace Angle Bolt Nut, for 954J .....
1522J	1061	Hanger Bolt Nut, for 954J .....
1522J	1061	" Bracket Stay Bar Coupling Bracket Bolt Nut, for 954J .....
1522J	1061	Leg Brace Bolt Nut, for 497J .....
1524E	1061	Guide Rack Bolt Nut, for 938E .....
1524E	1061	Tool Tray Bolt Nut, for 599E .....
1528C	1061	Carpet Height Guide Screw Nut ...
1528C	1061	Stop Bracket (for return machine) Screw Nut .....
1547J	1061	Looper Thread Tension Stud Lock Nut .....
1560C	1061	Looper Thread Tension Regulating Thumb Nut .....
1560C	1061	Needle Thread Tension Regulating Thumb Nut .....
1606C	1061	Stop Stud Nut, for 12687 .....
1608C	1061	Stretching Arm Lever Hinge Screw Nut .....

## Numerical List of Parts

No.	Plate	Name
1608c	1061	Stretching Arm Lever Link Hinge Screw Nut .....
1608c	1061	Stretching Arm Lever Link Screw Nut .....
1611E	1081	Stop Lever Hinge Screw Nut .....
1621E	1061	Binding Tension Spring Regulating Screw Nut, for 12820 .....
1677c	1081	Roller (lower) Stud (right) Nut, for Machine No. 36-3 .....
1876	1058	Needle Slide Roller and Screw Stud, for Machine No. 36-1 .....
1966	1081	Needle Slide Roller and Screw Stud, for Machine No. 36-3 .....
2022	1081	Starting Lever Pin .....
2049	1071	Driving Belt Roller Stud Pin (obso- lete) .....
2102	1056	Looper Thread Tension Disc .....
2102	1056	Needle Thread Tension Disc .....
2103	1057	Looper Thread Tension Spring .....
2103	1057	Needle Thread Tension Spring .....
2269	1057	Looper Thread Tension Bracket Po- sition Pin .....
2269	1057	Spreader Pinion Pin, for Machine No. 36-3 .....
2269	1057	Stop Stud Latch Pin Head Pin, for 11120 .....
3012	1057	Friction Wheel Pin .....
3012	1057	Needle Cam Pin .....
7071	1083	Spreader Connecting Rod Screw Washer, for Machine No. 36-3 .....
8078	1084	Belt Awl .....
8554	1081	Looper Bracket Steady Pin .....
8800	1072	Driving Belt Roller Screw Washer..
8800	1072	" " " Stud Washer, for 12687 .....
8800	1072	Roller (lower) Stud Screw Washer, for Machine No. 36-1 .....
8800	1072	Yielding Fork (right) Roller Stud Screw Washer .....
9281	1072	Brace Screw Washer .....
9534	1071	Hanging Arm Latch Spring .....
10195	1057	Feed Disengaging Lever Locking Pin Spring .....
11120	—	Stop Stud Latch Pin complete, Nos. 2269, 11121, 11122 and 11124, for 12687 .....
11121	1071	Stop Stud Latch Pin, for 11120 .....
11122	1071	" " " " Head, for 11120
11124	1071	" " " " Spring, for 11120

## Numerical List of Parts

No.	Plate	Name
11831	1084	Screw Driver (large) .....
12501	1053	Driving Belt Roller, for 12687 .....
12502	1053	" " " Support (left) with two 453c .....
12503	1053	Driving Wheel, for 12504 .....
12504	—	Driving Wheel complete, Nos. 401E, 12503, 12514, 12515, 12517, 12518, 12759 and two 12516 .....
12505	1052	Feed Disengaging Lever with 791c..
12506	1057	" " " Hinge Pin..
12507	1057	" " " Locking Pin
12508	1055	" Eccentric with 465c .....
12509	1057	" " Pin .....
12510	1052	" Lever .....
12511	1056	" " Slide Block .....
12512	1056	" Point .....
*12513	—	Frame, for Machine No. 36-1 .....
Nos. 12514 to 12518, for 12504		
12514	1053	Friction Wheel with 1143c .....
12515	1056	" " " Gib .....
12516	1057	" " " Position Pin .....
12517	1056	" " " Latch with 12519 .....
12518	1056	" " " Washer .....
12519	1057	" " " " Pin, for 12517 .....
12520	1054	Grip Lever .....
12521	1056	" " " Lock .....
12522	1055	" " " Bracket .....
12523	1057	" " " Spring .....
12524	1057	" " " " Hook .....
12525	1057	" " " Spring Hook, for 12689..
12526	1057	" " " " " 12523..
12527	1062	Guide, to sew Brussels .....
12528	1062	" " " Moquette, Velvet and Axminster .....
12529	1062	Guide, to sew serged edge and bor- der on Brussels .....
12530	1062	Guide, to sew American Axminster..
12532	1062	" " " Tapestry .....
12533	1062	" " " Wilton .....
12535	1053	" Holder Lock Catch (obsolete), for Machine No. 36-1 .....
12536	1052	Hand Wheel .....
12537	1055	Locking Cam with 465c .....
12538	1057	" " Pin .....
12539	1052	" Lever with 791c .....
12540	1056	" " Shaft Slide Block .....
12541	1056	" " Slide Block .....
12542	1056	" Point .....

## Numerical List of Parts

No.	Plate	Name
12543	1056	Looper .....
*12544	---	" Bracket, for Machine No. 36-1
12545	1055	" Cam with 465c .....
12546	1057	" " Pin .....
12546	1057	Spreader Cam Pin .....
12547	1053	Looper Lever with 193c, for Machine No. 36-1 .....
12548	1055	Looper Lever Strap, for Machine No. 36-1 .....
12549	1056	Looper Lever Strap Division Block
12550	1057	" Position Point .....
12557	1053	" Thread Tension Bracket .....
12558	1052	Needle Cam with 445c, for Machine No. 36-1 .....
12560	1056	Needle Guide, for Machine No. 36-1
12561	1052	" Slide (obsolete), for Machine No. 36-1 .....
12562	1052	Needle Slide Bar .....
12564	1056	" " Gib, for Machine No. 36-1
12565	1057	" " " Pin .....
12566	1057	" Thread Guide .....
12568	1056	" " Take-up Block, for Machine No. 36-1 .....
12569	1056	Needle Thread Take-up Eyelet .....
12570	1052	Piler, for Machine No. 36-1 .....
12571	1055	Pull-off .....
12572	1055	Return Belt Roller .....
12573	1053	Roller (lower) .....
12574	1053	" " Stud (right), for Machine No. 36-1 .....
12575	1053	Roller (lower) Stud (left) .....
12576	1055	Safety Catch .....
12577	1055	" " Bracket .....
12578	1057	" " Hinge Pin .....
12580	1052	Shaft, for Machine No. 36-1 .....
12581	1056	Spreader, for Machine No. 36-1 .....
12582	1055	" Cam with 465c .....
12584	1053	" Lever, for Machine No. 36-1
12585	1052	Starting Lever .....
12586	1056	" " Trip .....
12587	1057	" " Hinge Pin .....
12588	1057	" " Spring .....
12589	1052	Stop Lever (obsolete), for Machine No. 36-1 .....
12590	1056	Stop Lever Friction Pad (rawhide)
12591	1057	" " Hinge Pin (obsolete), for Machine No. 36-1 .....
12592	1052	Stop Lever Spring .....

## Numerical List of Parts

No.	Plate	Name
12594	1055	Tripping Lever .....
12595	1055	" " Finger .....
12596	1057	" " " Hinge Pin .....
12597	1057	" " " Spring .....
12598	1057	" " Spring .....
12599	1054	Yielding Fork (left) .....
12601	1054	" " (right) Roller .....
12602	1054	" " Spring .....
12603	1054	" " (left) Roller Stud .....
12605	---	Belt .....
12610	1072	Belt Coupling complete, Nos. 12772, two each 12773 and wood screws 3/4 in., No. 9 .....
12614	1057	Clamping Arm Spring Hook, for 12697 and 12626
12617	1086	Clamping Jaw Spur, for 12699 .....
12620	1072	Brace Angle Bolt Washer
12624	1072	" " (lower) Bolt Washer .....
12629	1072	Hanger Bolt Washer .....
12641	1072	Stop Bracket Pad (rawhide), for 12728 .....
12643	1071	Stop Bracket Pawl Spring .....
12648	1072	Starting Lever Trip Pawl Spring .....
12668	1076	Belt Compressor complete, Nos. 12669 to 12671 and three wood screws 1 in., No. 10 .....
Nos. 12669 to 12671, for 12668		
12669	1076	Belt Compressor Bracket .....
12670	1076	" " Lever .....
12671	1071	" " " Hinge Pin .....
12672	---	Clamp (stretching) Strap .....
12673	1057	Hanging Arm Latch Pin, for 12745
12674	1071	Stop Bracket Pawl Stop Pin .....
12675	1052	Feed Guide .....
12676	1052	" " Stud (eccentric), for Machine No. 36-1 .....
12677	1054	Yielding Fork (right) .....
12678	1054	" " (left) Roller .....
12679	1054	" " (right) Roller Stud .....
12680	1054	" " " Spring .....
Nos. 12681 to 12686, for 12687		
12681	1071	Driving Belt Roller Stud .....
12682	1075	Stop Stud .....
12683	1076	" " Arm with two 457c .....
12684	1076	" " Bracket with two 445c
12685	1071	" " " Hinge Pin .....
12686	1076	" " Latch Bracket .....

## Numerical List of Parts

No.	Plate	Name
12687	—	Removable Machine Stop and Belt Support complete, Nos. 191c, 1606c, 8800, 11120, 12681 to 12686, 12830, 12831, two each 180e and 12501 ..
12688	1062	Guide, to sew Ingrain, for Machine No. 36-1 .....
12689	1057	Grip Lever Spring .....
Nos. 12690 to 12692, for 12811		
12690	1077	Belt Adjusting Bracket with two 795c
12691	1079	" " Rod, length 3 ft. 7 inches
12691	1079	Hanger Bracket Stay Bar (intermediate), length 3 ft. 7 in., for 3 ft. 7 in. section .....
12692	1077	Belt Adjusting Rod Pulley, 6½ in. diameter .....
12693	1078	Brace (long), 3 ft. 7 in. section ...
12694	1078	" Angle (lower) .....
12695	1078	" " (upper) .....
12696	1076	Carpet Height Guide .....
12697	1080	Clamping Arm with 12614 .....
12698	1073	" Jaw (inside) .....
12699	1073	" " (outside) with 12617 ...
12700	1076	Driving Belt Adjusting Bracket with 611b, for 12811 .....
12705	1076	Feed Rack (each end) .....
12706	1076	" " (intermediate), 3 ft. 7 in. section .....
12707	1077	Hanger with 436c, 1517E, two each 430c, 445c and 1520j .....
12708	1077	Hanger (intermediate) with two each 430c, 445c and 1520j .....
12709	1077	Hanger Bracket .....
12714	1077	Hanging Arm with 448c .....
12715	1077	" " Latch with 12673 ...
12716	1072	" " Spur, for 12835 .....
12717	1072	" " Holder, for 12835 .....
12718	1078	Leg .....
12719	1076	Name Plate with two 448c, for 12811
12720	1076	Return Belt Adjusting Bracket with 611b, for 12811 .....
12721	1077	Starting Lever with 795c .....
12722	1073	" " Trip Pawl .....
12723	1079	" Rod (end) (left), for 3 ft. 7 in. section .....
12724	1073	Starting Rod (end) Collar with 363c
12725	1079	" " " (right), for 3 ft. 7 in. section .....

## Numerical List of Parts

No.	Plate	Name
12726	1079	Starting Rod (intermediate), for 3 ft. 7 in. section .....
12727	1073	Starting Rod (intermediate) Collar with 363c, for 12715 .....
12728	1076	Stop Bracket with 363c, 12641 and two 190b .....
12729	1076	Stop Bracket (for return machine)
12730	1071	" " Pawl .....
12731	1077	Stretching Arm with 429c, 453c, 795c and 1513j .....
12732	1077	Stretching Arm Lever .....
12733	1073	" " " Link .....
12734	1073	" Clamp (inside) .....
12735	1073	" " " Bracket with 453c .....
12736	1073	Stretching Clamp (outside) .....
12738	1071	" " (inside) Hinge Pin
12738	1071	" " (outside) Hinge Pin
12739	1079	Track Rod (end, upper) (left), length 4 ft. 7 in., for 3 ft. 7 in. section .....
12740	1079	Track Rod (intermediate, upper), length 3 ft. 7 in., for 3 ft. 7 in. section .....
12742	1079	Hanger Bracket Stay Bar (end) (left), length 3 ft. 8½ in., for 3 ft. 7 in. section .....
12743	1076	Hanger Bracket Stay Bar Coupling with two 795c .....
12744	1076	Hanger Bracket Stay Bar Coupling Bracket with 795c .....
12745	1078	Brace (short), for 3 ft. 7 in. section
12746	1062	Guide, to sew Imperial Axminster and heavy Wilton, for Machine No. 36-1 .....
12747	1052	Piler, to be used only with 12746, for Machine No. 36-1 .....
12748	1063	Guide, to sew extra thick serged edge .....
12749	1054	Looper Thread Spool Rest Disc ...
12749	1054	Needle Thread Spool Rest Disc ...
12750	1054	Looper Thread Cone Center (wood)
12750	1054	Needle Thread Cone Center (wood)
12751	1054	Looper Thread Spool Clamping Disc
12751	1054	Needle Thread Spool Clamping Disc
12753	1084	Wrench, for 873E .....
12754	1080	Tool Tray .....
12755	1063	Guide, to sew Brussels (turned edge), for Machine No. 36-1 .....
12756	1054	Looper Thread Spool Bracket .....

## Numerical List of Parts

No.	Plate	Name
12757	1054	Needle Thread Spool Bracket .....
12759	1057	Friction Wheel Latch Spring, for 12504 .....
Nos. 12760 to 12768, for 12769		
12760	1076	Clamp (stretching) Strap Eyelet
12761	1071	" " " "
Hinge Pin .....		
12762	1076	Clamp Stretching Jaw (right) .....
12763	1076	" " " (left) .....
12764	1076	" " Link .....
12765	1071	" " Hinge Pin .....
12766	1071	" " Spring .....
12767	1071	" " Hook .....
12768	1071	" " " " .....
12769	1076	Clamp (stretching) complete, Nos. 12760, 12762, 12763, 12766 to 12768, two each 12761, 12764 and 12765...
12770	1072	Belt Coupling Joint Ball, for 12772
12771	1072	" " " " Rivet, for 12772 .....
12772	—	Belt Coupling Joint complete, Nos. 12771, two each 873c and 12770, for 12610 .....
12773	1072	Belt Coupling Sleeve, for 12610 .....
12774	1057	Gauge, for 12512 and 12542 .....
12776	1053	Driving Belt Roller Support (right) with two 453c .....
Nos. 12778 to 12780, for 12789		
12778	1077	Power Transmitter Frame with three 968c .....
12779	1077	Power Transmitter Gear with 445c and 888c .....
12780	1077	Power Transmitter Gear Cover .....
12782	1077	Machine Driving Pulley, 8 in. diam., with 445c and 888c, for 12789 ...
Nos. 12784 to 12787, for 12789		
12784	1075	Power Transmitter Machine Driving Pulley Shaft .....
12785	1075	Power Transmitter Machine Driving Pulley Shaft Bushing (eccentric)
12786	1077	Power Transmitter Machine Return Pulley, 6½ in. diam., with 445c and 888c .....
12787	1075	Power Transmitter Machine Return Pulley Shaft .....

## Numerical List of Parts

No.	Plate	Name
12788	1075	Power Transmitter Pinion with 445c and 888c (obsolete) .....
12789	—	Power Transmitter complete, Nos. 12778 to 12780, 12782, 12784 to 12787, 12838 and three 145c .....
12790	1063	Guide, to sew Matting .....
12791	1063	" " " " .....
12792	1063	" " " " .....
12793	1063	" " " " .....
Nos. 12794 to 12796, for 12801		
12794	1077	Counter Shaft Driving Belt Bracket with three 363c .....
12795	1075	Counter Shaft Driving Belt Bracket Shaft .....
12796	1079	Counter Shaft Driving Belt Bracket Shaft Pulley, 8 in. diam. (grooved, loose) .....
12797	1078	Counter Shaft Driving Belt Bracket Shaft Pulley, 8 in. diam. (flat), with 909c .....
12798	1078	Counter Shaft Driving Belt Bracket Shaft Pulley, 9 in. diam. (flat), with 909c .....
12799	1078	Counter Shaft Driving Belt Bracket Shaft Pulley, 10 in. diam. (flat), with 909c .....
12800	1078	Counter Shaft Driving Belt Bracket Shaft Pulley, 12 in. diam. (flat), with 909c .....
12801	—	Counter Shaft complete, Nos. 524c, 12794 to 12796, 12805, 12810, 14044 and one length of belting 10 ft. by 1½ in., with two hooks .....
12802	1063	Guide, to sew Matting, for Machine No. 36-3 .....
12803	1063	Guide, to sew Matting, for Machine No. 36-1 .....
12804	1054	Guide, to sew Moquette (turned edge) .....
12805	1079	Counter Shaft Driving Belt Bracket Shaft Pulley, 8 in. diam. (grooved, tight), with 909c, for 12801 .....
12806	1073	Stretching Clamp (inside) Spring ..
12807	1073	" " (outside) Spring ..
12808	1073	" " Shield .....
12809	1080	Guide Rack (wood) with eleven name plates and twenty-two pins

## Numerical List of Parts

No.	Plate	Name
12810	1078	Counter Shaft Driving Belt Bracket Shaft Pulley, 11 in. diam. (flat), with 909c, for 12801 .....
12811	—	Belt Adjuster complete, Nos. 12690, 12700, 12719, 12720, two each 819c, 12691, 12692 and three 967E .....
12812	1080	Leg Brace .....
12813	1072	Brace Angle (upper) Bolt Washer..
12813	1072	Leg Brace Bolt Washer .....
12814	1064	Guide, to sew Matting .....
12815	1064	" " " " .....
Nos. 12816 to 12819, for 12820		
*12816	1075	Binding Holder Base .....
12817	1075	" " Bracket .....
*12818	1075	" " Rim .....
12819	1075	" " Supporting Arm .....
12820	1075	Binding Holder complete, Nos. 172c, 236E, 401E, 812B, 1621E, 12816 to 12819, 12821, 12822, two 402D and three 233D, for 12823 .....
12821	1075	Binding Tension Spring, for 12820..
12822	1075	" " Bracket, for 12820 .....
12823	—	Binder complete, Nos. 12820 and 12824 .....
12824	1075	Guide, for binding, for 12823 .....
12825	1079	Track Rod (end, upper) (right), length 4 ft. 7 in., for 3 ft. 7 in. section .....
12826	1079	Track Rod (intermediate, upper), length 3 ft. 7 in., for 12690, for 3 ft. 7 in. section .....
12827	1079	Track Rod (end, lower) (left and right), length 4 ft. 7 in., for 3 ft. 7 in. section .....
12828	1079	Track Rod (intermediate, lower), length 3 ft. 7 in., for 3 ft. 7 in. section .....
12829	1079	Track Rod (intermediate, lower), length 3 ft. 7 in., for 12690, for 3 ft. 7 in. section .....
12830	1079	Track Rod (lower), length 3 ft. 7 in- ches, for 12687 .....
12831	1079	Track Rod (upper), length 3 ft. 7 in- ches, for 12687 .....
12832	1079	Hanger Bracket Stay Bar (end) (right), length 3 ft. 9½ in., for 3 ft. 7 in. section .....

## Numerical List of Parts

No.	Plate	Name
12833	1052	Piler, to be used only with 12804, for Machine No. 36-1 .....
12834	1071	Clamping Arm Spring .....
12835	1072	Hanging Arm Spur Holder 12717 with 12716 .....
12836	1080	Hanger with 12614, two each 430c, 445c and 1520r .....
12837	1080	Hanger Bracket .....
12838	1082	Power Transmitter Pinion with 445c and 888c, for 12789 .....
12843	1082	Guide Holder Body, for 12845 .....
12844	1082	" " Plate, for 12845 and 12848 .....
12845	—	Guide Holder complete, Nos. 212E, 1149c, 12843 and 12844, for Ma- chine No. 36-1 .....
Nos. 12847 to 12852, for Machine No. 36-3		
12847	1082	Guide Holder Body, for 12848 .....
12848	—	Guide Holder complete, Nos. 212E, 1149c, 12844 and 12847 .....
*12849	—	Looper Bracket .....
12850	1082	" Lever with 193E .....
12851	1082	Needle Cam with 445c .....
12852	1081	" Guide .....
Nos. 12854 to 12870, for Machine No. 36-3		
12854	1081	Needle Thread Take-up Block .....
12855	1082	Piler .....
12856	1085	" to be used only with 12804 .....
12857	1081	" Connecting Rod .....
12858	1081	Roller (lower) Stud (right) .....
12859	1083	Spreader .....
12860	1083	" Connecting Rod (rack) .....
12861	1083	" " Plate .....
12862	1082	" Lever .....
12863	1083	" " Cap .....
12864	1083	" Pinion .....
12865	1083	" " Cover .....
12866	1082	Stop Lever .....
12867	1083	" " Spring Support Pin .....
12868	1085	Guide, to sew Brussels .....
12869	1081	Needle Slide Gib .....
12870	1081	Looper Lever Strap .....
12871	1082	" Thread Spool Post, 5½ in. long
12871	1082	Needle Thread Spool Post, 5½ in. long .....
12872	1081	Stop Lever Spring Support Pin, for Machine No. 36-1 .....

## Numerical List of Parts

Nos. 12873 to 12877, for Machine No. 36-3

No.	Plate	Name
12873	1085	Guide, to sew Nap Axminster (coarse) .....
12874	1085	Guide, to sew Moquette (flat seam)
12875	1085	" " " Nap Axminster (coarse)
12876	1085	" " " Wilton (for taking the fullness) .....
12877	1085	Piler, to be used only with 12873 ..
12878	—	Brace (long), for 3 ft. section track
12879	—	" (short), for 3 ft. section track
12880	—	Feed Rack (intermediate), for 3 ft. section track .....
12881	—	Hanger Bracket Stay Bar (end) (left), length 3 ft. 1½ in., for 3 ft. section track .....
12882	—	Hanger Bracket Stay Bar (end) (right), length 3 ft. 2½ in., for 3 ft. section track .....
12883	—	Hanger Bracket Stay Bar (intermediate), length 3 ft., for 3 ft. section track .....
12884	—	Starting Rod (end) (left), for 3 ft. section track .....
12885	—	Starting Rod (end) (right), for 3 ft. section track .....
12886	—	Starting Rod (intermediate), for 3 ft. section track .....
12887	—	Track Rod (end, lower) (left and right), length 4 ft., for 3 ft. section .....
12888	—	Track Rod (end, upper) (left), length 4 ft., for 3 ft. section .....
12889	—	Track Rod (end, upper) (right), length 4 ft., for 3 ft. section .....
12890	—	Track Rod (intermediate) (lower), length 3 ft., for 3 ft. section .....
12891	—	Track Rod (intermediate) (lower), length 3 ft., for 12690, for 3 ft. section .....
12892	—	Track Rod (intermediate) (upper), length 3 ft., for 3 ft. section .....
12893	—	Track Rod (intermediate) (upper), length 3 ft., for 12690, for 3 ft. section .....

Nos. 12894 to 12899, for Machine No. 36-3

12894	—	Shaft .....
12895	1081	Feed Guide Stud (eccentric) .....
*12896	—	Frame .....

## Numerical List of Parts

No.	Plate	Name
12897	1082	Needle Slide .....
12898	1082	" " " Guide Block .....
12899	1081	" " " " Stud .....
12900	1082	" Slide, for Machine No. 36-1 ..
12902	1086	Piler Connecting Rod Guide, for Machine No. 36-3 .....
12903	—	Driving Belt Bracket Shaft Pulley, 13 in. diam. (flat), with 909c ...
12904	—	Driving Belt Bracket Shaft Pulley, 14 in. diam. (flat), with 909c ...
12905	—	Driving Belt Bracket Shaft Pulley, 15 in. diam. (flat), with 909c ...
14044	1072	Counter Shaft Driving Belt Bracket Shaft Screw Washer, for 12801 ..
19221	1084	Wrench, for 611D .....
26151	1084	Screw Driver, Nos. 120090 and 120091
26346	1084	Pliers (4 in. flat nose) .....
50252 <sub>F</sub>	1081	Grip Lever Lock Regulating Screw
50252 <sub>F</sub>	1081	Looper Lever Strap Division Block Screw .....
51001c	1086	Stretching Arm Lever Link Hinge Screw (for first section) .....
*120090	—	Screw Driver Handle, for 26151 .....
*120091	—	" " " Blade, for 26151 .....
120341	1084	Tweezers (curved) .....
120346	1084	Oiler (copper plated) with 120347..
120347	1084	" Spout, 9 in. long, for 120346 ..
202244	—	Counter Shaft Driving Belt Bracket Shaft Oil Wick .....
210805	1086	Guide Rack Bolt Washer .....
210805	1086	Tool Tray Bolt Washer .....

**ILLUSTRATIONS OF PARTS**

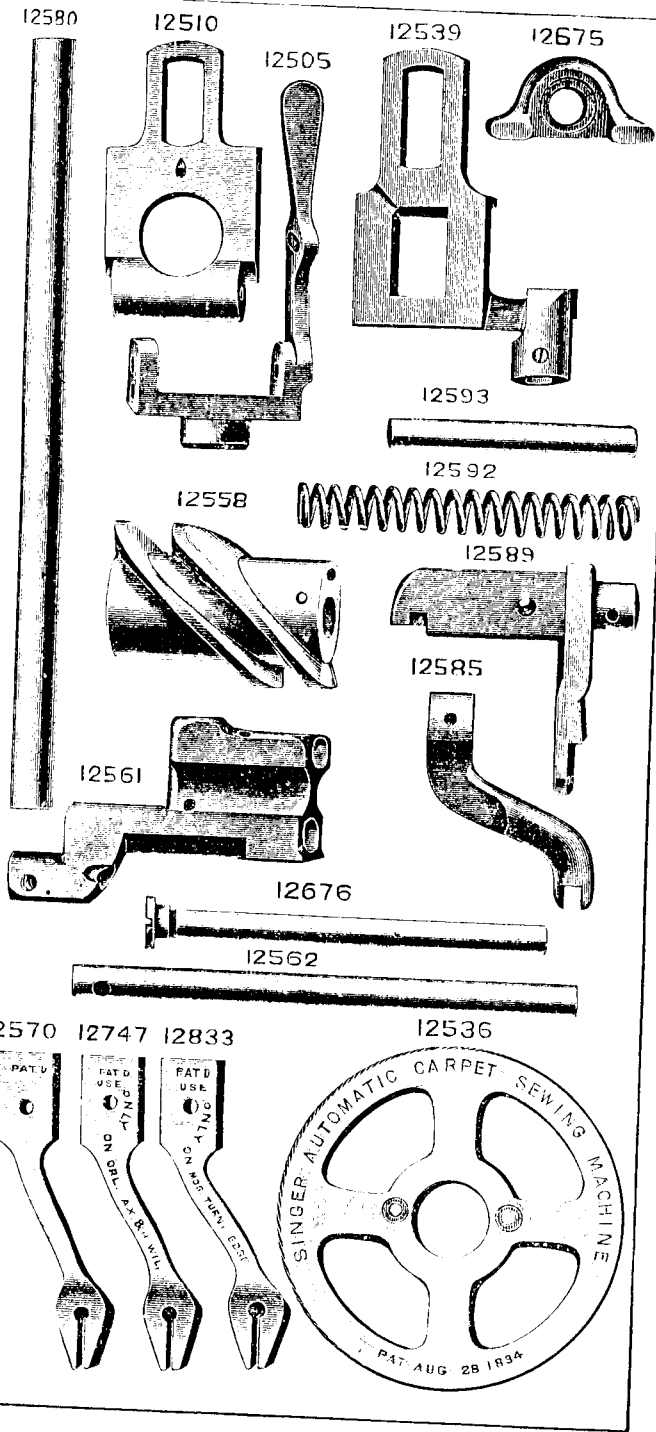
**FOR**

**MACHINES**

**Nos. 36-1 and 36-3**



PLATE 1052 - ONE HALF SIZE



ILLUSTRATIONS OF PARTS

FOR

SEWING MACHINES

No. 38-1 and 38-2

PLATE 1053—ONE-HALF SIZE

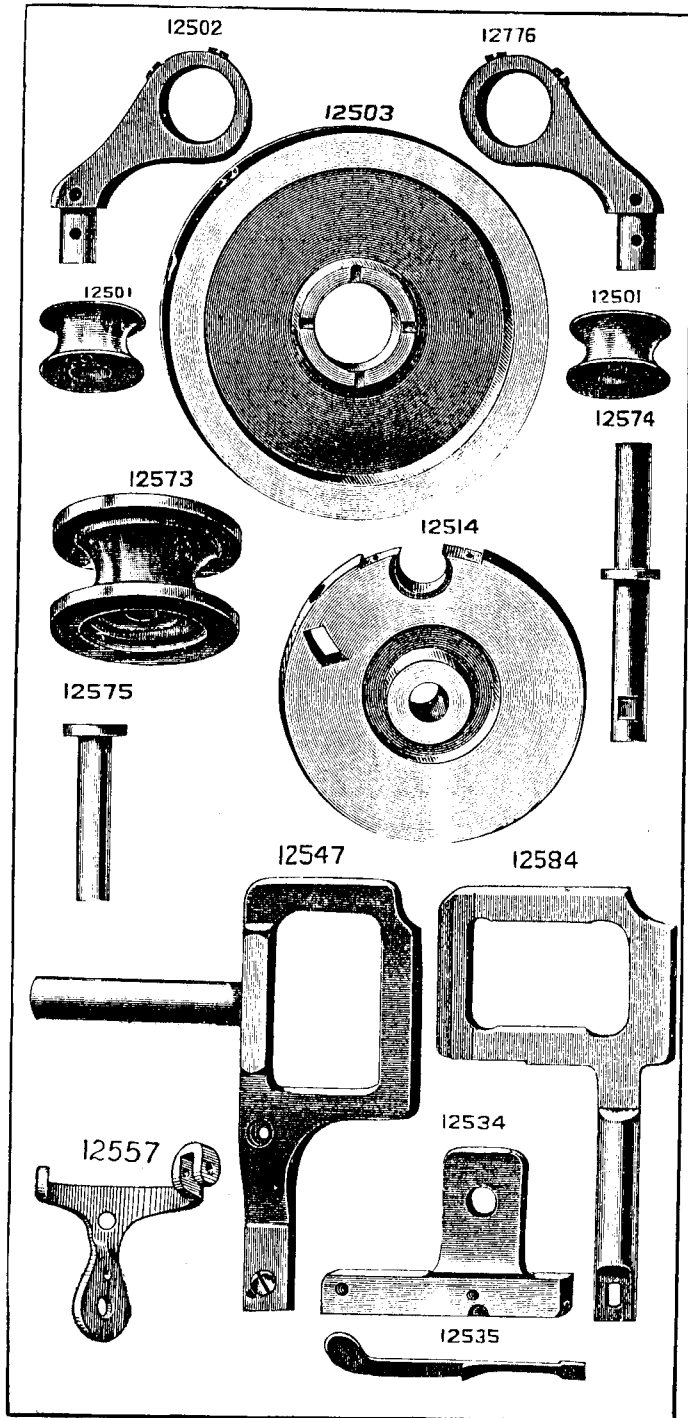


PLATE 1054—ONE-HALF SIZE

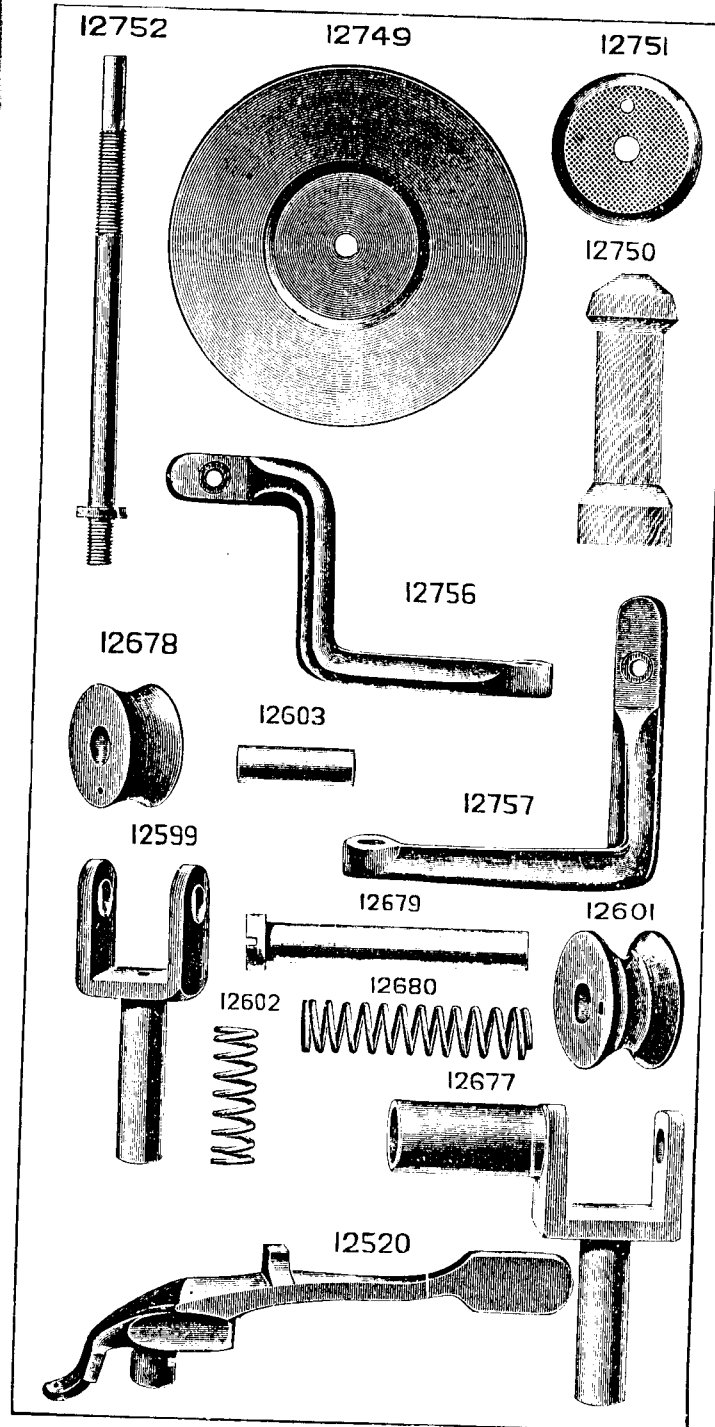


PLATE 1055—FULL SIZE

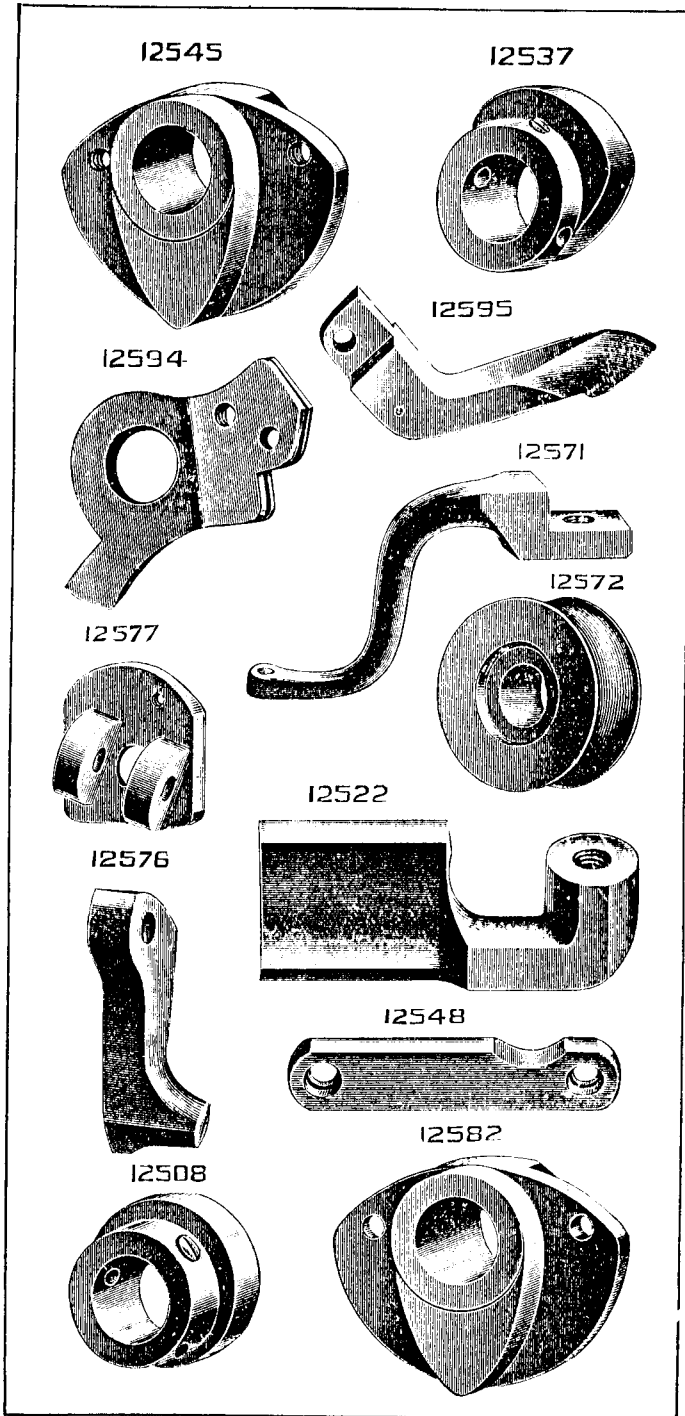


PLATE 1056—FULL SIZE

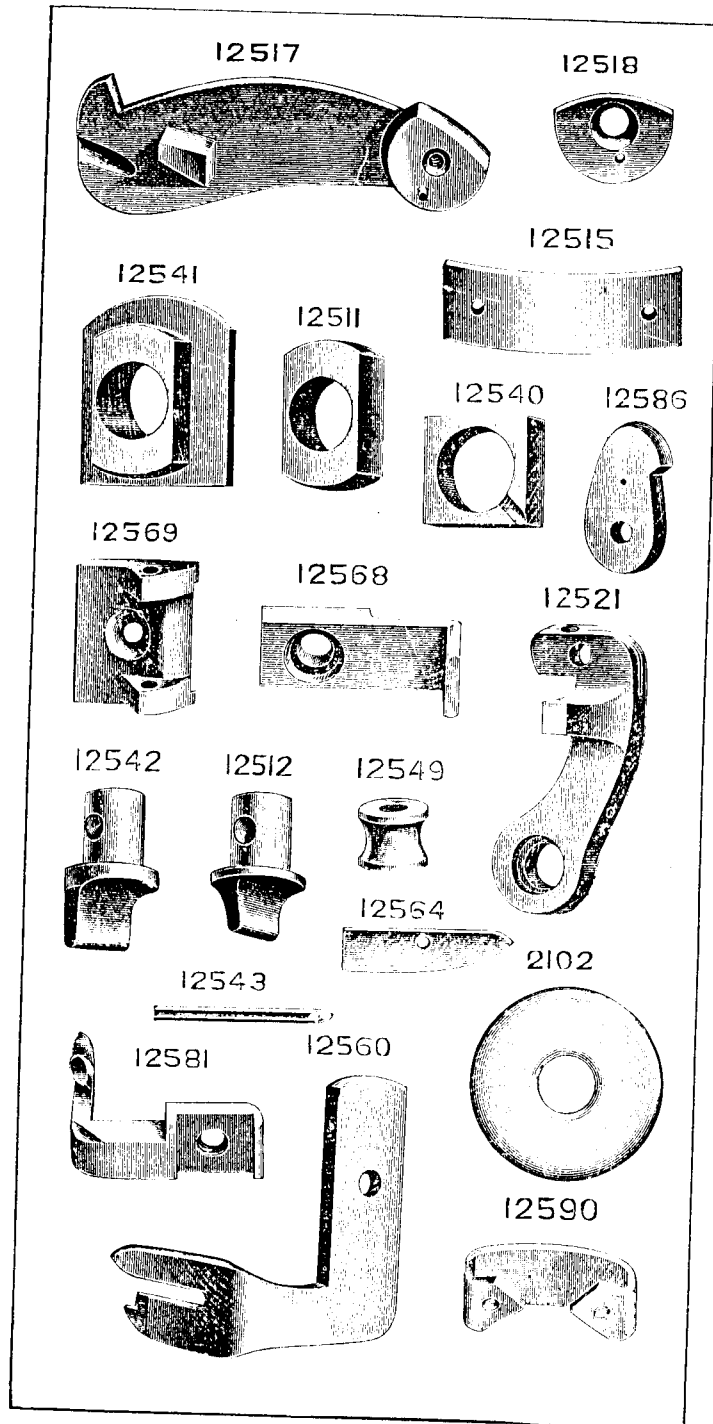


PLATE 1057—FULL SIZE

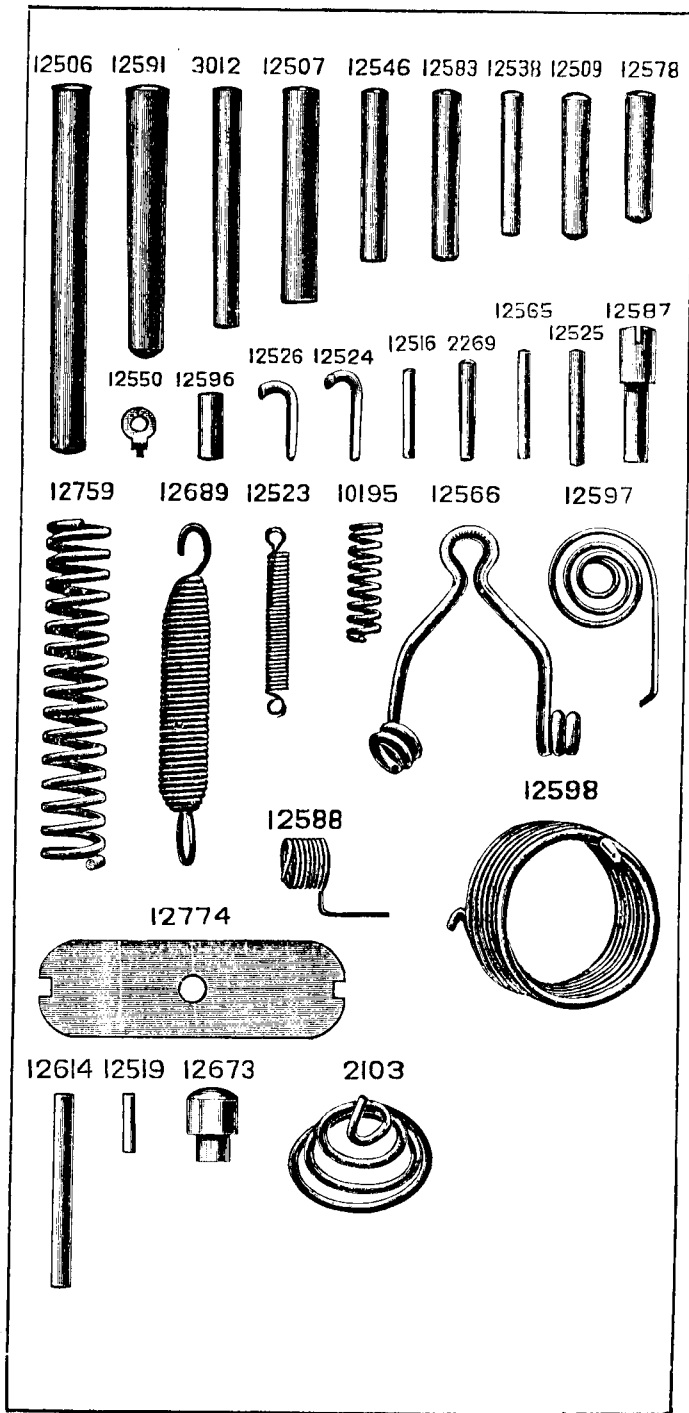


PLATE 1058—FULL SIZE

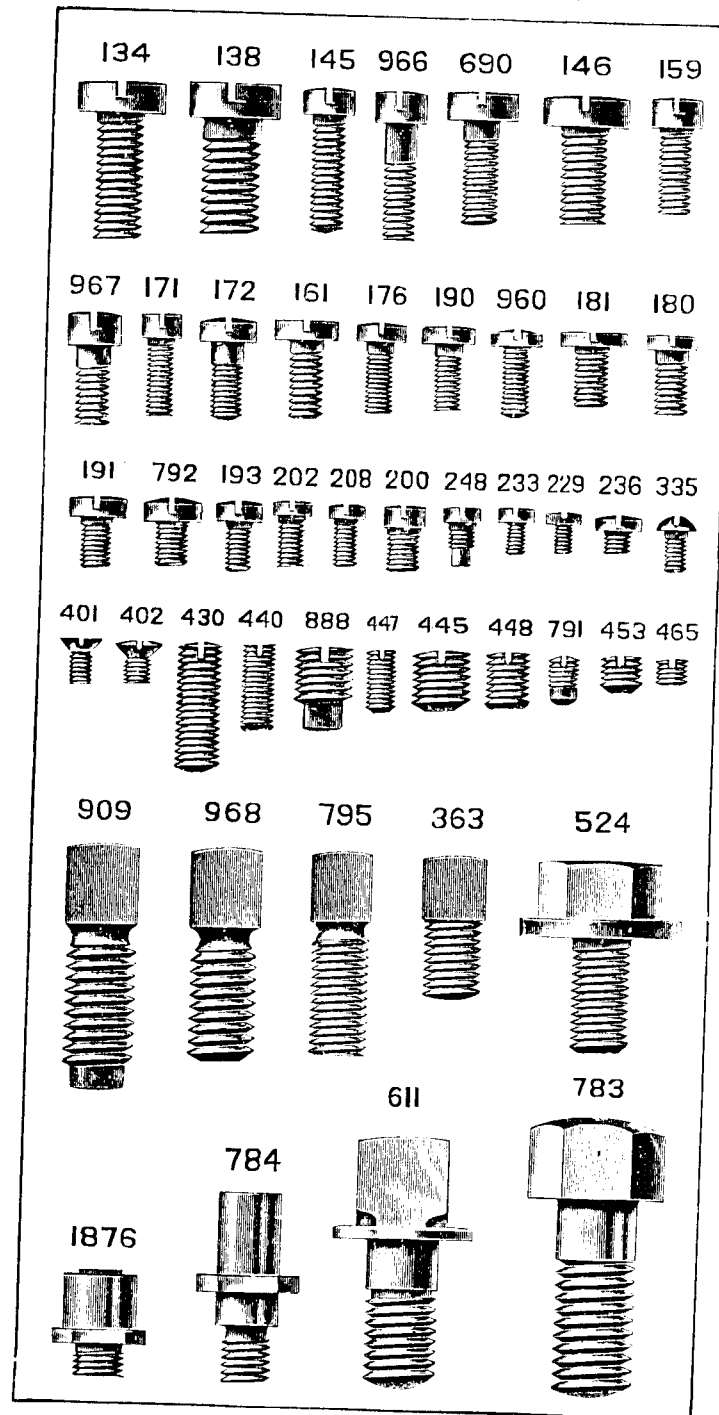


PLATE 1059—FULL SIZE

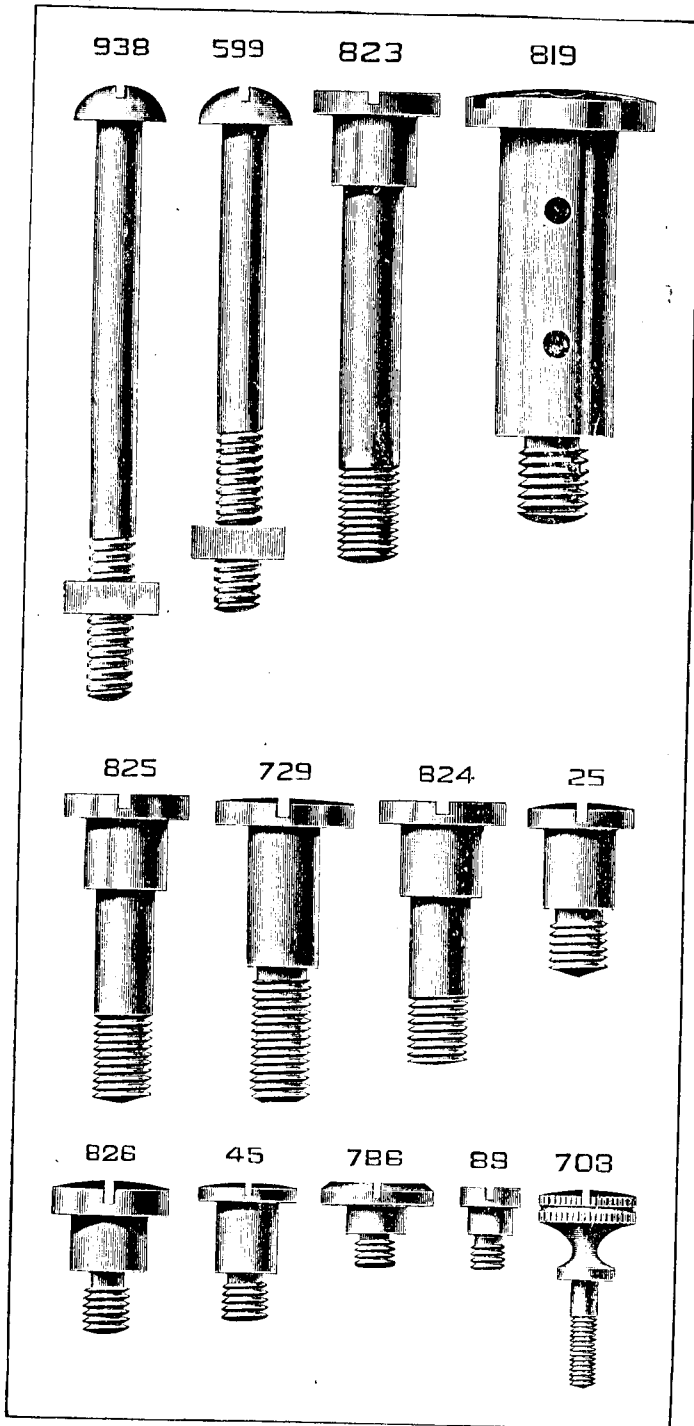


PLATE 1060—FULL SIZE

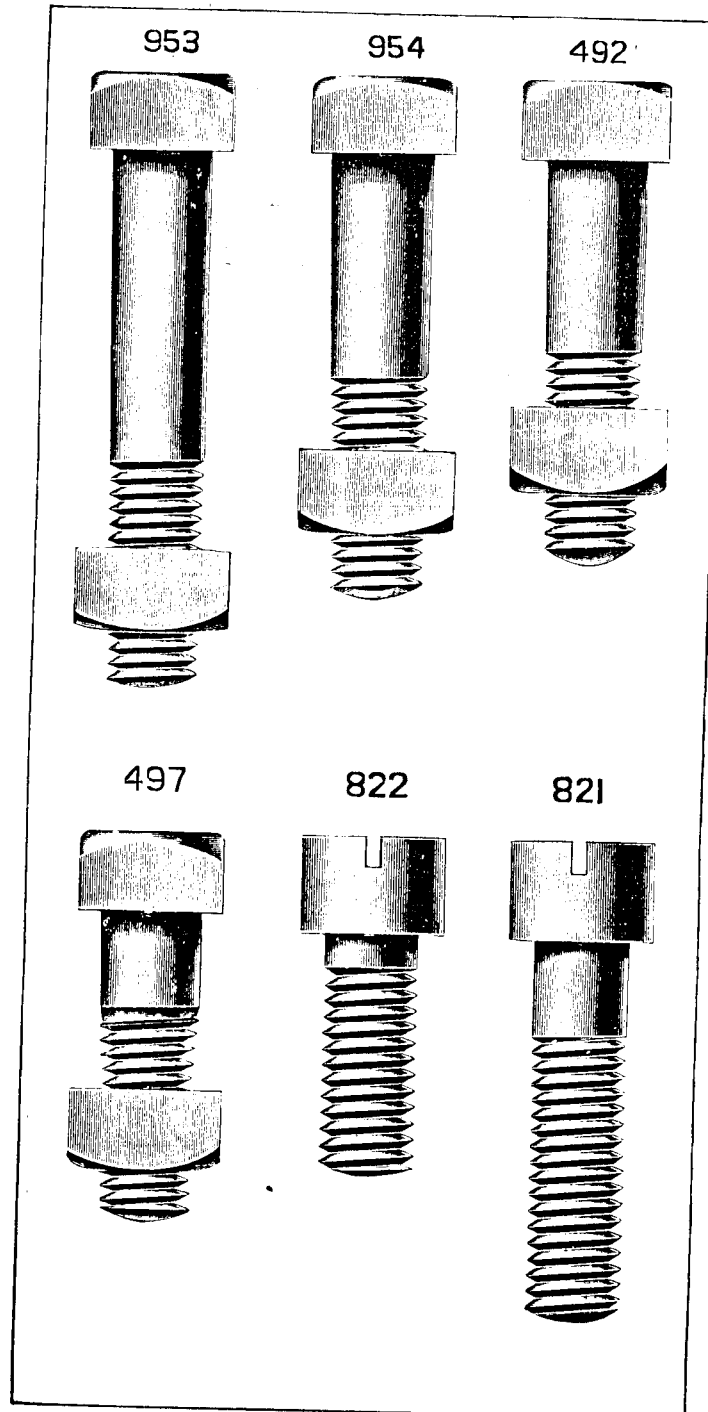
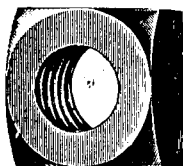
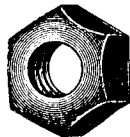


PLATE 1061—FULL SIZE

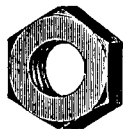
1522



1606



1608



1524



1560



1519



1520



1547



1528



956



812

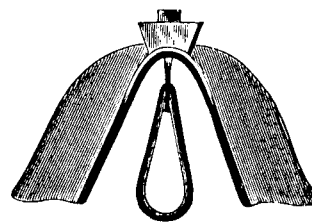


1621

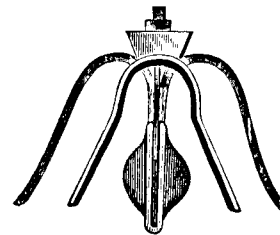


PLATE 1062—FULL SIZE

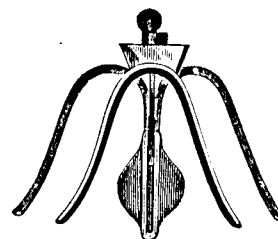
12527



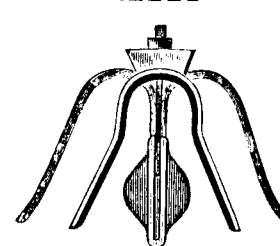
12528



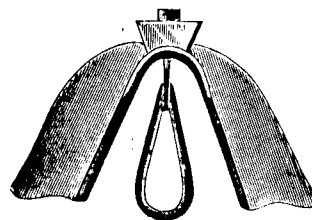
12529



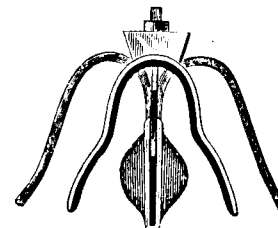
12530



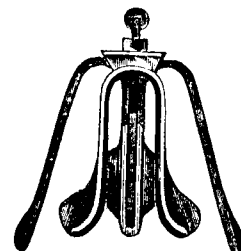
12532



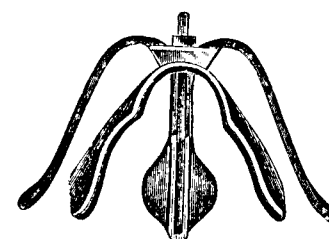
12533



12688



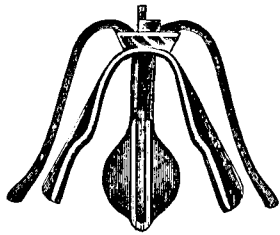
12746



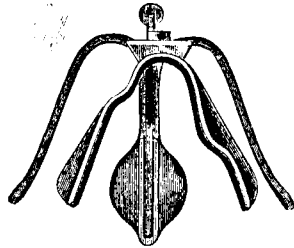
END VIEW OF GUIDES SHOWING EXACT SIZE.

PLATE 1063—FULL SIZE

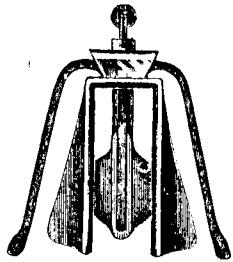
12748



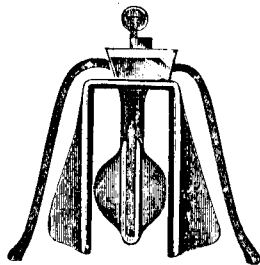
12755



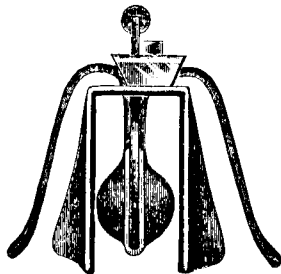
12790



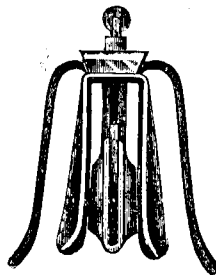
12791



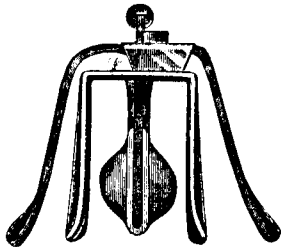
12792



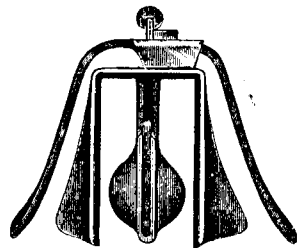
12793



12802



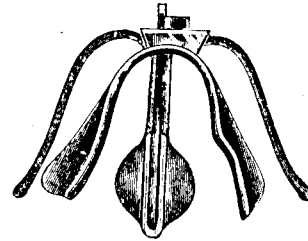
12803



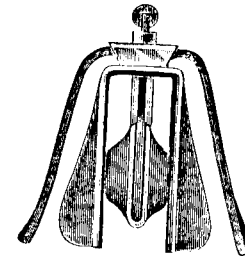
END VIEW OF GUIDES SHOWING EXACT SIZE.

PLATE 1064—FULL SIZE

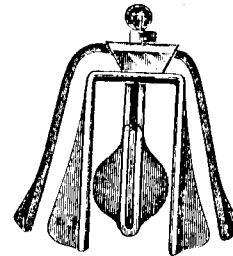
12804



12814



12815



END VIEW OF GUIDES SHOWING EXACT SIZE.

PLATE 1071—FULL SIZE

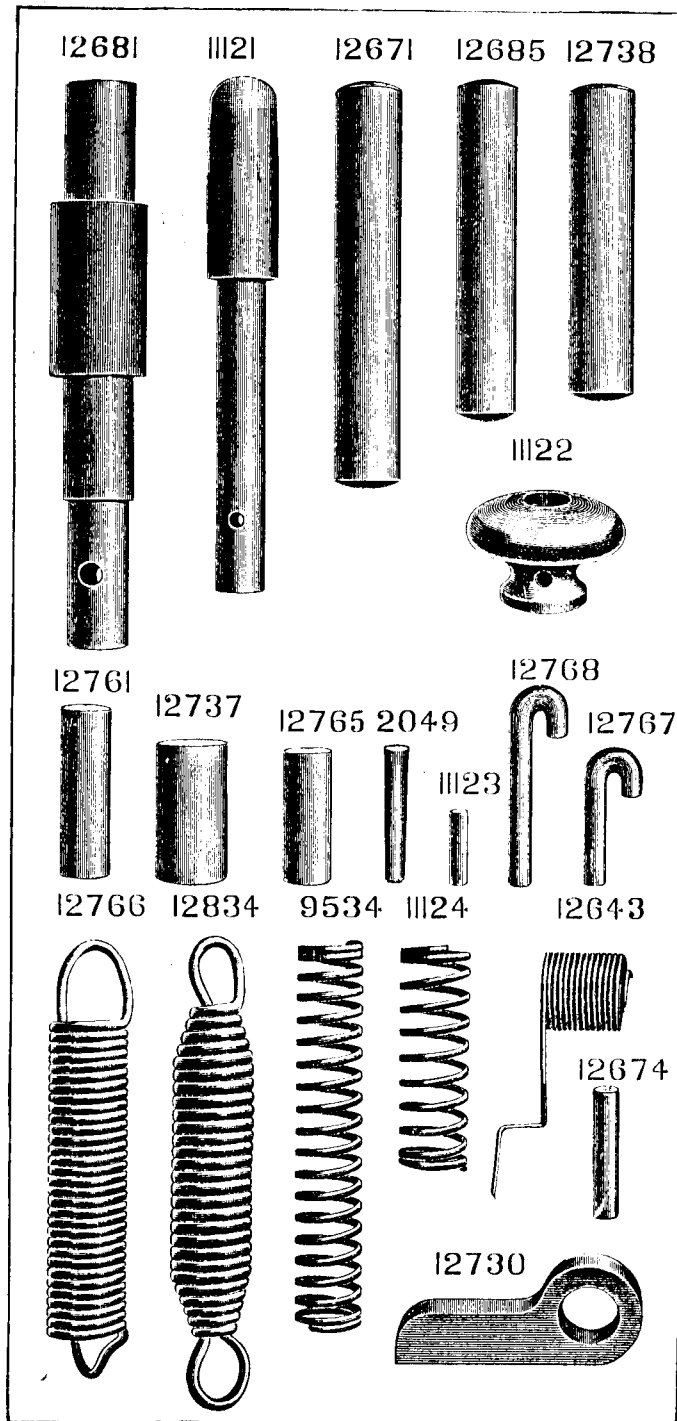


PLATE 1072—FULL SIZE

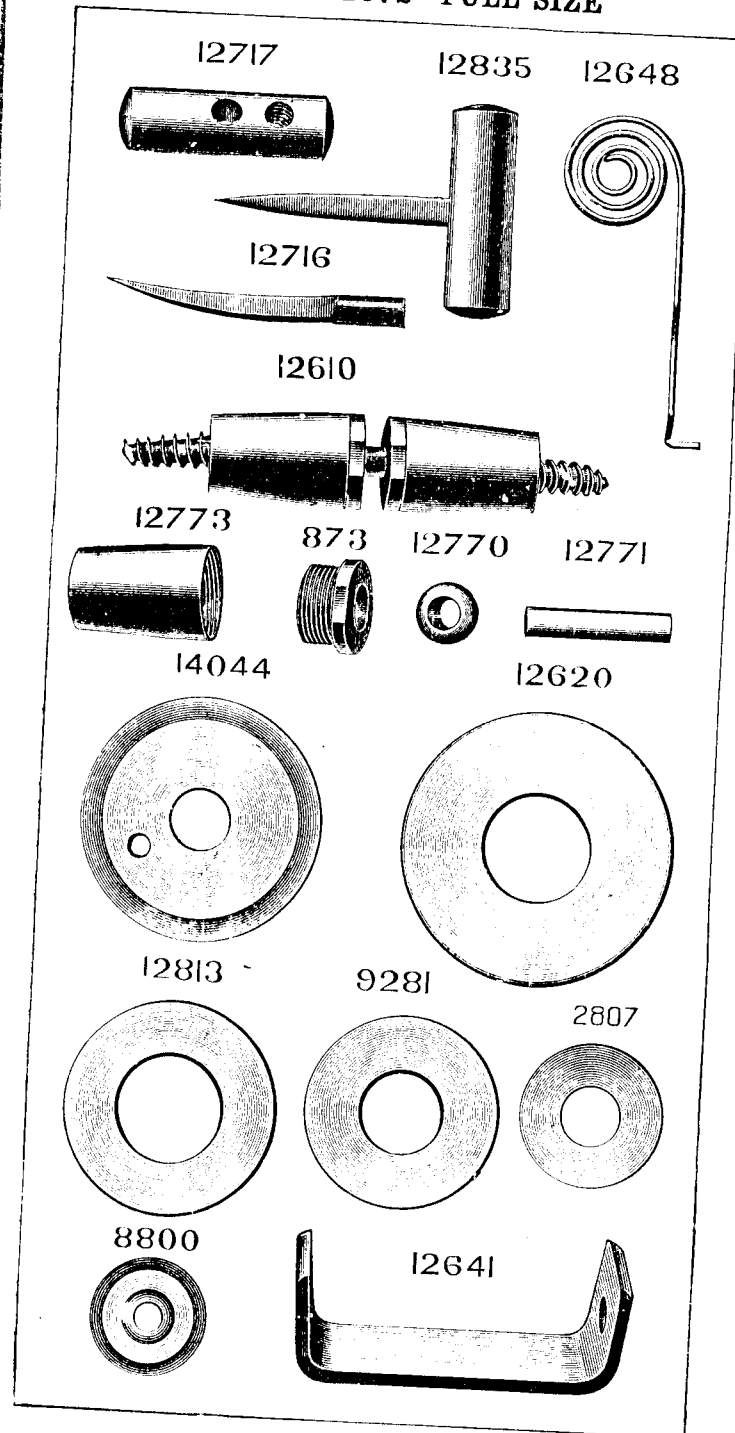




PLATE 1073—ONE-HALF SIZE

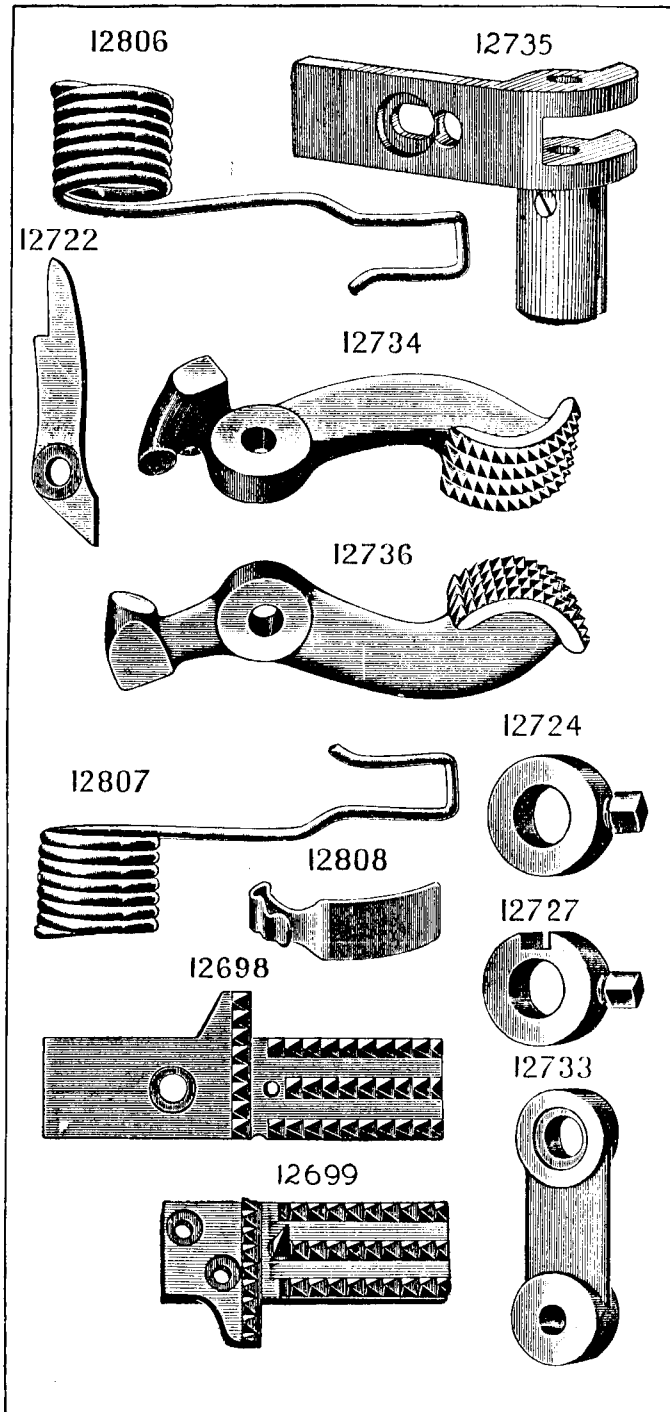


PLATE 1075—ONE-HALF SIZE

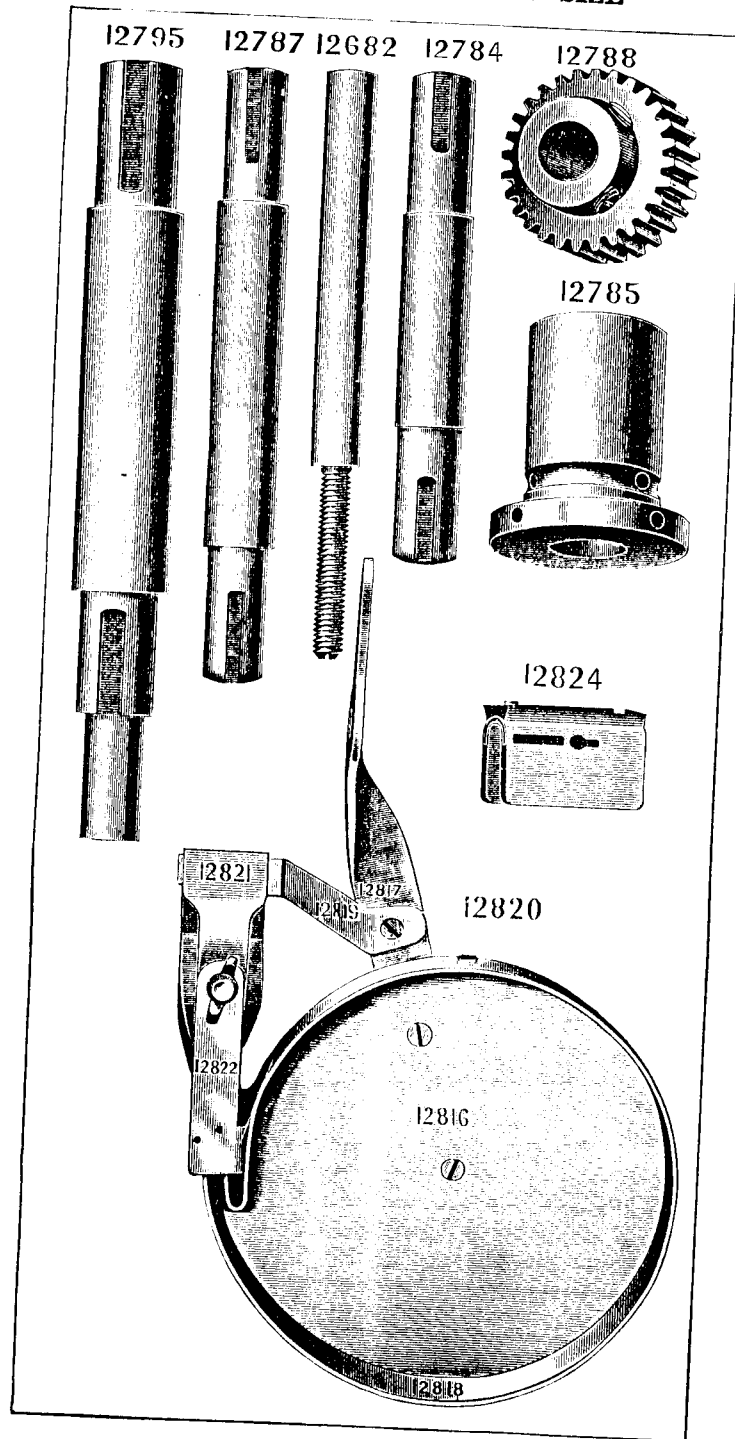


PLATE 1076—ONE-FOURTH SIZE

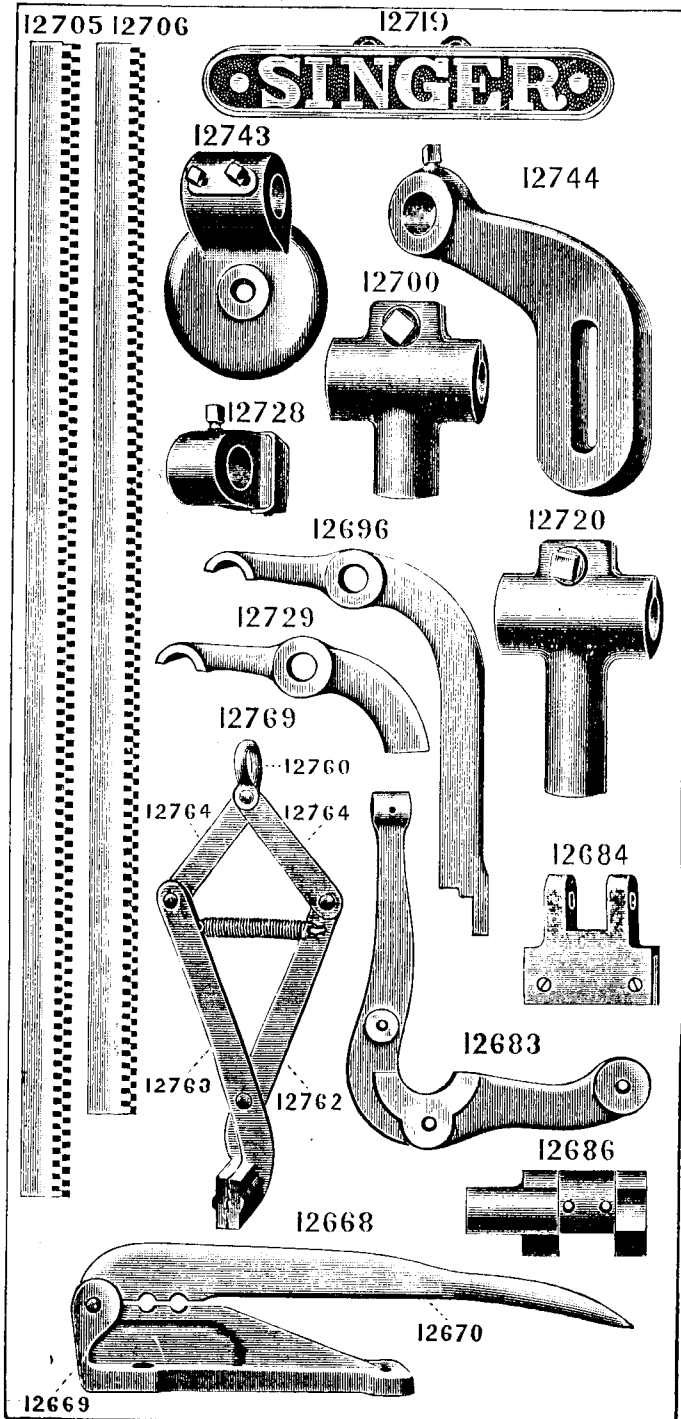


PLATE 1077—ONE-EIGHTH SIZE

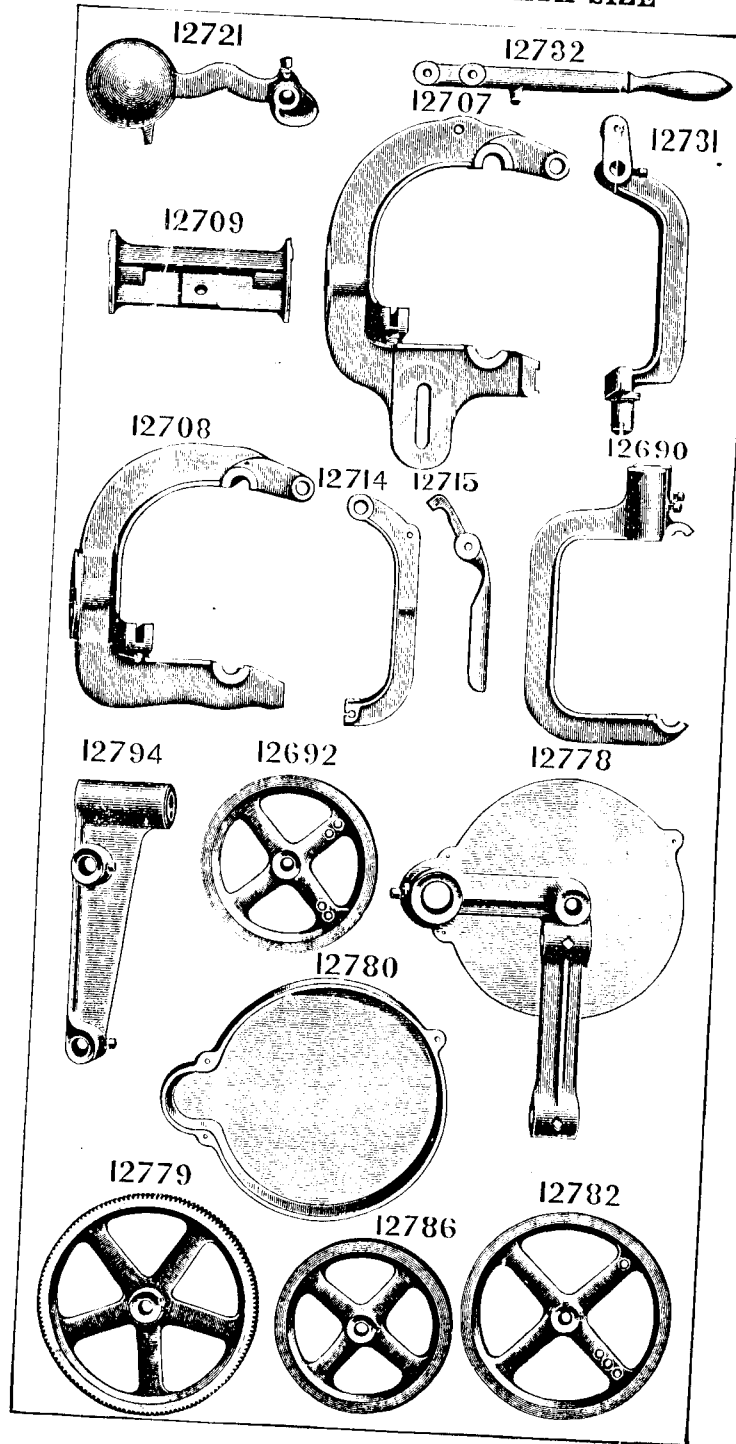


PLATE 1078—ONE-EIGHTH SIZE

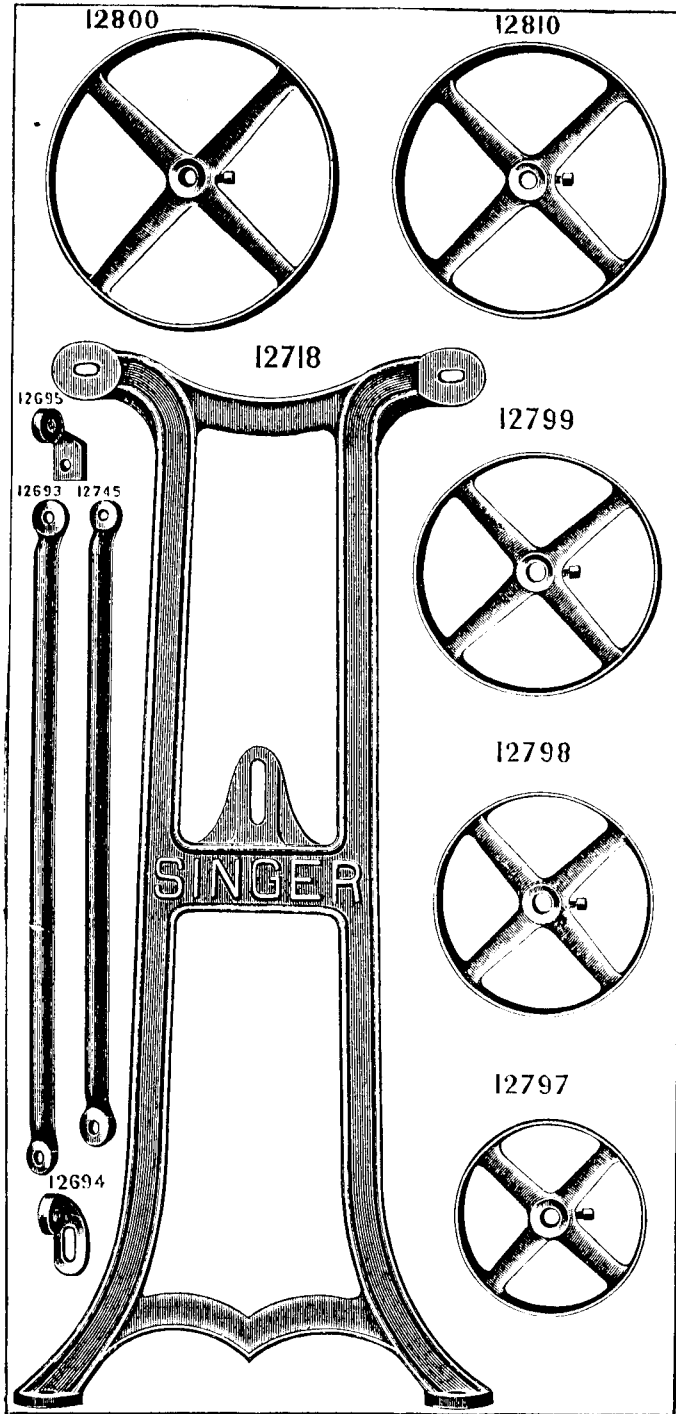


PLATE 1079—ONE-EIGHTH SIZE

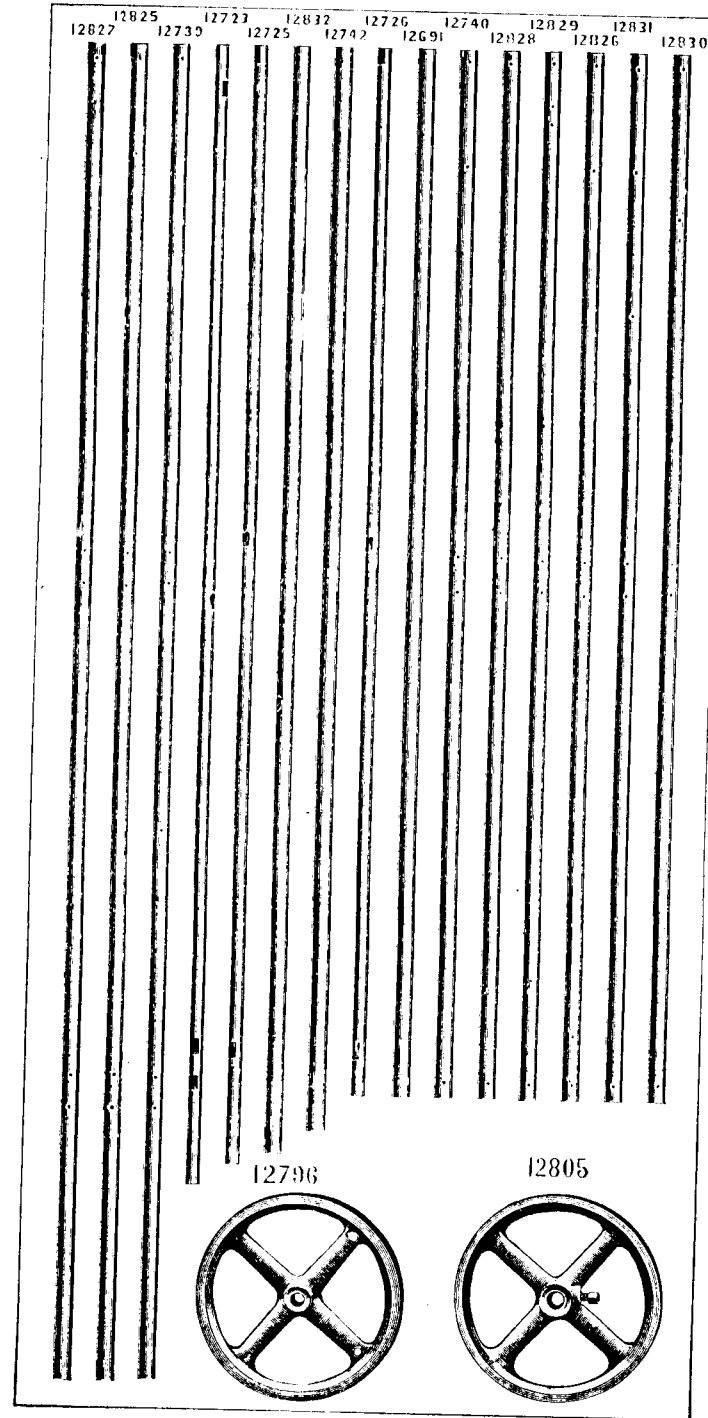


PLATE 1080—ONE-EIGHTH SIZE

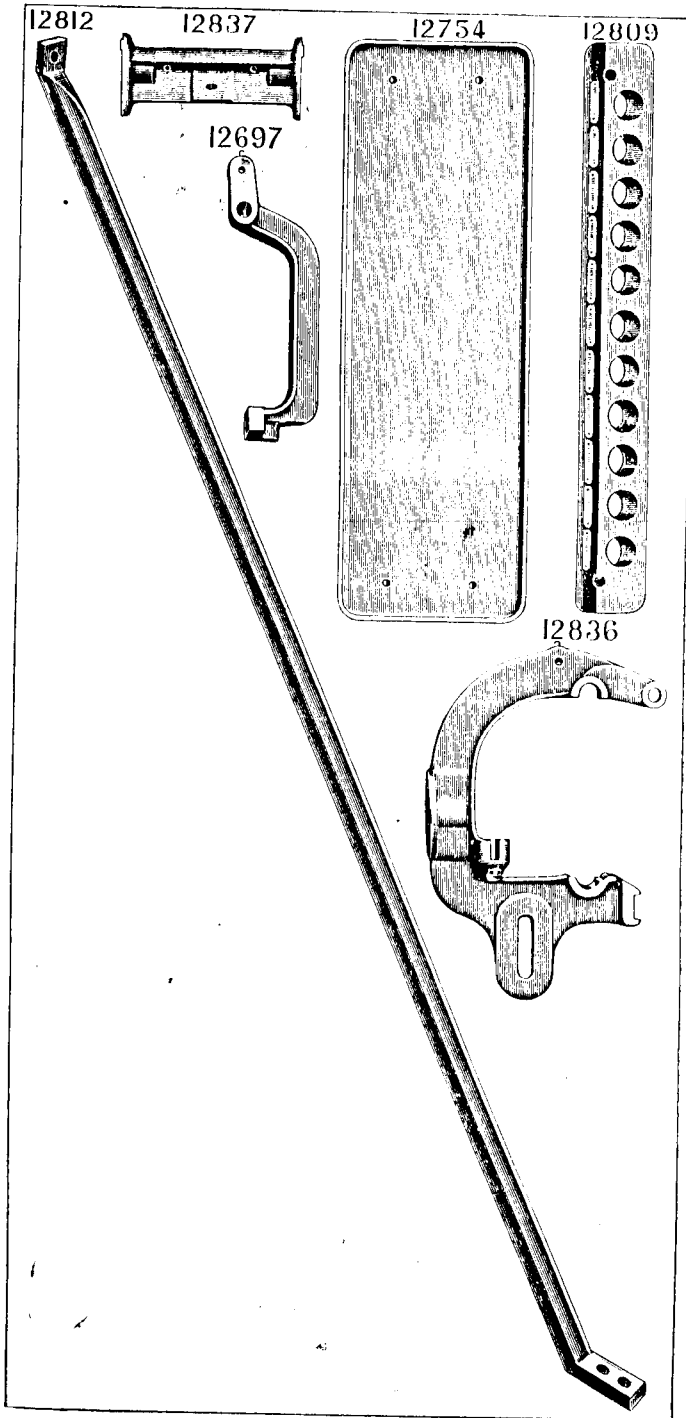


PLATE 1081—FULL SIZE

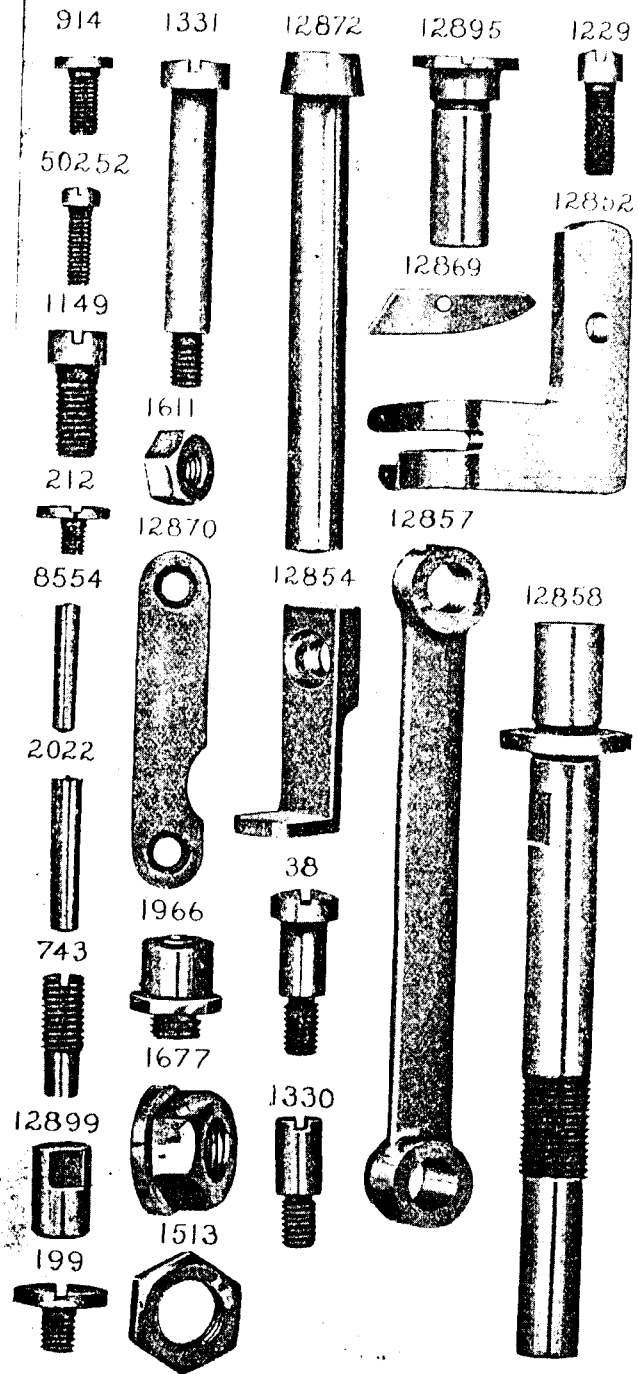


PLATE 1082—ONE-HALF SIZE

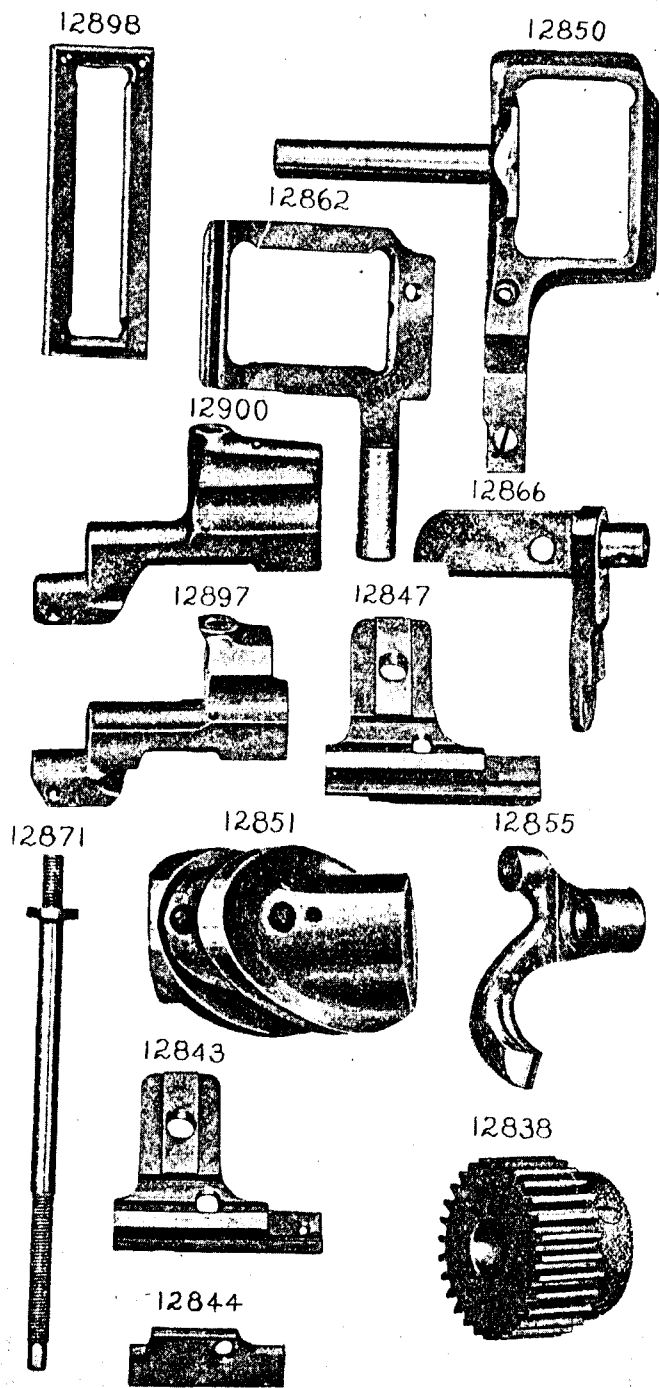


PLATE 1083—FULL SIZE

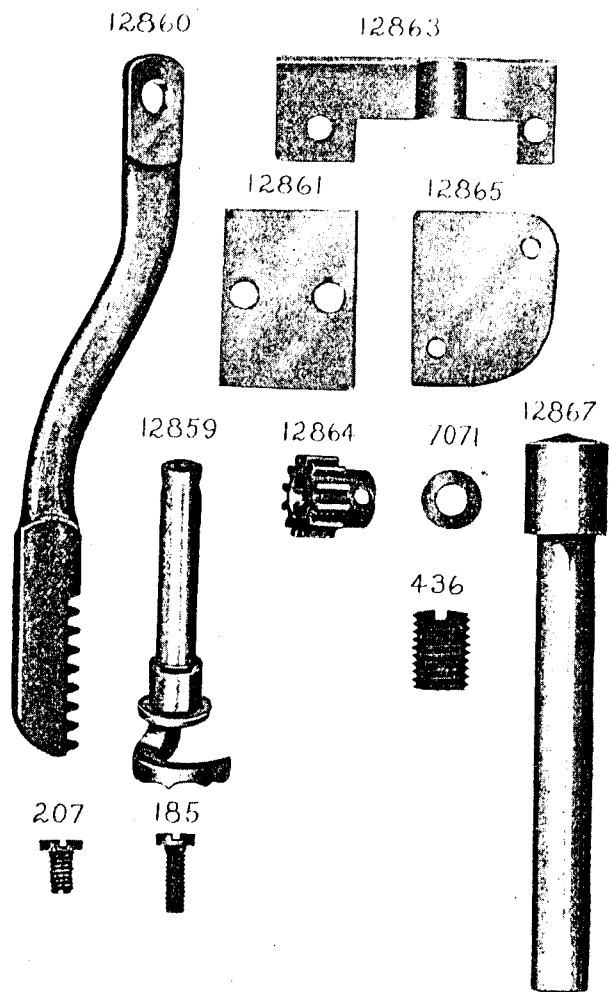


PLATE 1084—ONE-HALF SIZE

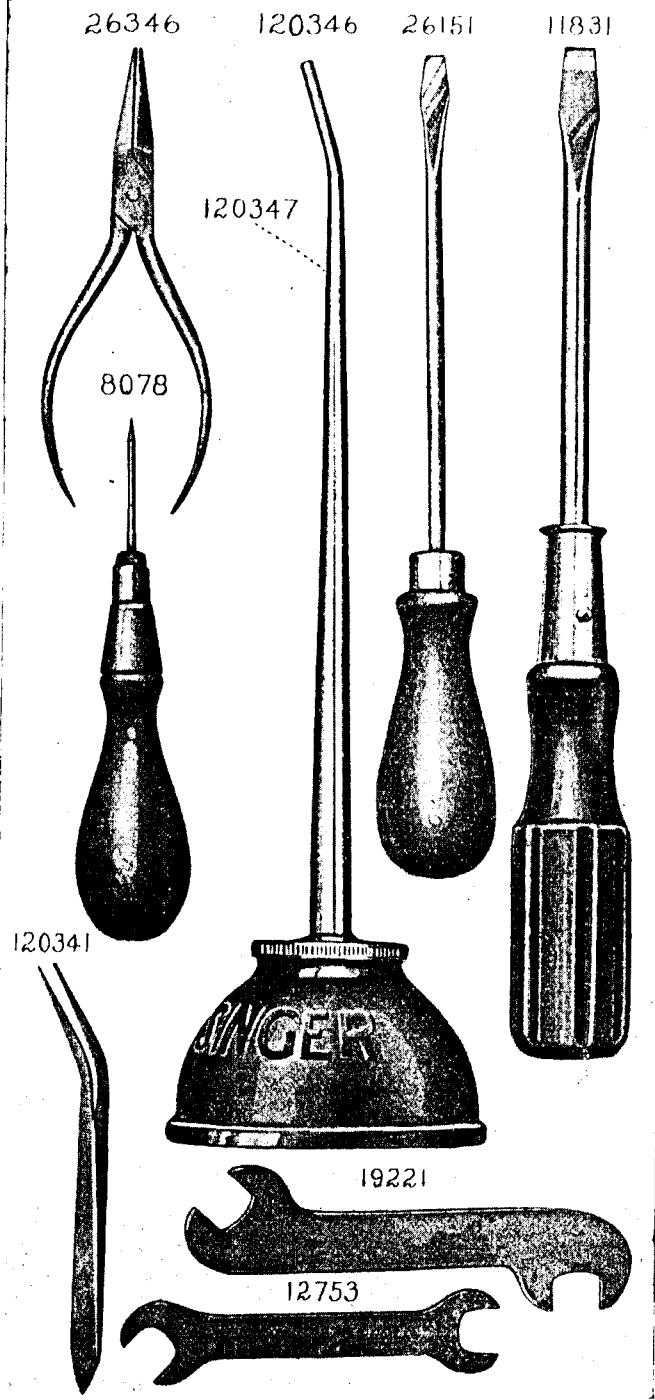


PLATE 1085—ONE-HALF SIZE

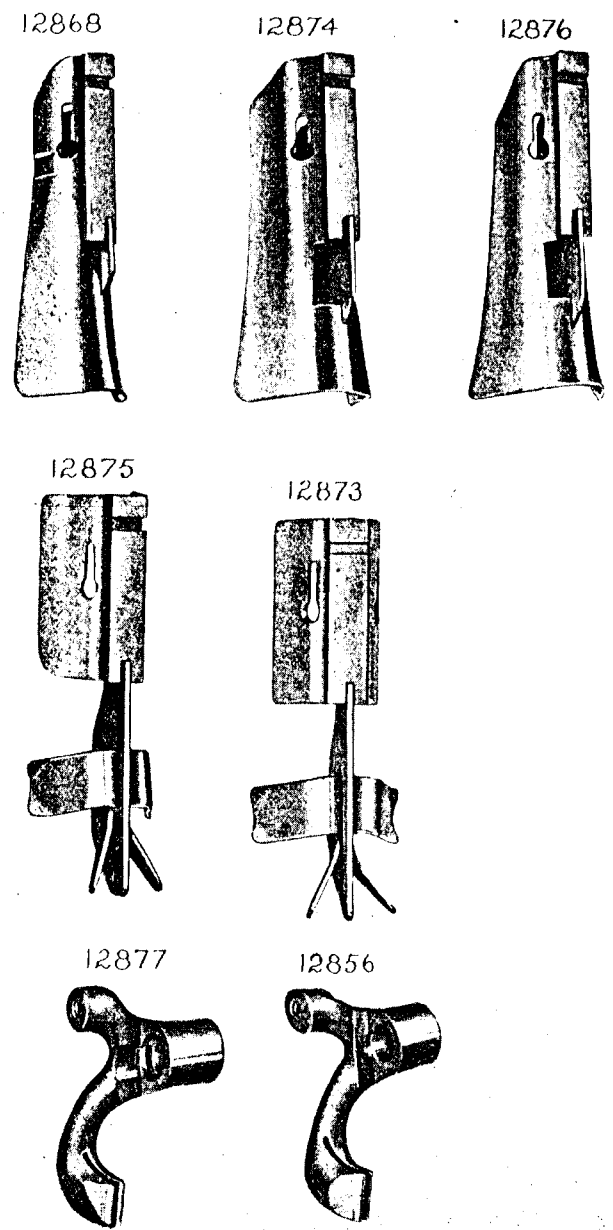


PLATE 1086—FULL SIZE

51001



12617

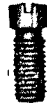


457

210805



1143



429



1517



12902

