

SINGER

245-4

Form 20353
(Rev. 658)
Printed in U. S. A.

LIST OF PARTS



SINGER^{**}

MACHINE No. 245-4

THE SINGER MANUFACTURING COMPANY

** A Trademark of THE SINGER MANUFACTURING COMPANY

INSTRUCTIONS FOR OILING

To insure easy running and prevent unnecessary wear of the parts which are in movable contact, the machine requires oiling and when in continuous use, "TYPE B" or "TYPE D" OIL, sold by Singer Sewing Machine Company, should be applied at least four times each day to all oil holes and points of contact marked "OIL", as instructed in Form 1979I.

"TYPE D" OIL should be used when an oil is desired which will produce a minimum of stain on fabrics, even after a long period of storage.

Apply a few drops of oil to the bobbin case bearings each time a bobbin case is replaced.

CAUTION: Never oil the sewing hook race through the needle hole in the throat plate. Never flood the hook with oil.

Apply "GEAR LUBRICANT" to upper and lower gear cases every 160 hours of operation, as indicated in Form 1979I.

INDEX

	Page
Accessories	16
Bobbin Winders	16
Finger Guard	18
Grease Guns	18
Knee Lifter Parts	18
Machine Base	20
Machine No. 245-4	7
Numerical List of Parts	21
Thread Unwinder	20

INSTRUCTIONS FOR ORDERING

In ordering from this list, use ONLY the part NUMBER in the FIRST column.

The number stamped on a Sewing Machine Part is in every case the number of the single part only.

Every combination of parts sent out as such has its specific number, which, although not stamped on the parts, must be used when ordering the combination.

Each number always indicates the SAME PART in whatever list it appears, or for whatever machine.

The letters after some of the numbers indicate the style of finish only, as follows:

- A—Hardened, Polished, Nickel Plated and Buffed
- B—Polished, Nickel Plated and Buffed
- C—Hardened Only
- D—Polished Only
- E—Soft, Not Polished
- F—Hardened and Polished
- G—Bright Rumbled and Nickel Plated
- H—Blued
- J—Nickel Plated Only
- K—Hardened and Nickel Plated
- L—Brass Plated
- M—Oxidized
- R—Phosphate Coating Formed on Surface of Iron or Steel
- S—Cadmium Plated
- T—Copper Plated
- U—Zinc Plated
- V—Silver Plated
- W—Polished and Nickel Plated
- X—Black Oxide for Iron and Steel
- Y—Black Nickel Plated Only
- Z—Chromium Plated
- A.A—Buffed and Chromium Plated
- A.B—Hardened, Polished, Buffed and Chromium Plated
- A.E—Hardened, Bright Rumbled and Nickel Plated
- A.F—Hardened, Bright Rumbled, Nickel Plated, Bright Rumbled and Chromium Plated
- A.G—Alumilite (Plain)
- A.H—Alumilite (Dyed) Color Must be Stated
- A.J—Polished, Nickel Plated and Chromium Plated
- A.K—Hardened, Polished, Nickel Plated and Chromium Plated
- A.L—Heat Treated for Toughness
- A.L.D—Heat Treated for Toughness and Polished
- A.L.X—Heat Treated for Toughness and Black Oxide

INSTRUCTIONS FOR ORDERING

- A.S—Black Moulded Phenolic
- A.T—Beige Moulded Phenolic
- A.U—Brown Moulded Phenolic
- A.W—Hardened then Flame Coated with Tungsten Carbide
- B.A—Chrome Nickel Satin Finish
- B.B—Hardened and Chrome Nickel, Satin Finished
- C.R—Hardened and Phosphate Coating Formed on Surface of Steel
- F.J—Hardened, Polished and Nickel Plated
- T.A—Hardened, Polished, Copper and Nickel Plated and Buffed
- T.B—Copper and Nickel Plated and Polished
- T.J—Copper and Nickel Plated Only
- T.K—Hardened, Copper and Nickel Plated
- T.L—Copper and Brass Plated
- T.M—Copper Plated and Oxidized
- X.C—Hardened and Black Oxide for Iron and Steel
- Z.A—Hardened, Polished Nickel Plated, Buffed and Chromium Plated
- Z.B—Polished, Nickel Plated, Buffed and Chromium Plated
- Z.C—Hardened and Chromium Plated
- Z.D—Polished and Chromium Plated
- Z.G—Bright Rumbled, Nickel Plated, Bright Rumbled and Chromium Plated
- Z.J—Nickel and Chromium Plated
- Z.T—Copper and Chromium Plated

These letters MUST BE USED when they appear in the list; and AFTER the number as in the list.

In this series:

1 to 1500, 50001 to 51500 and 140001 to 142,000 are screw numbers
1501 to 1800 and 51500 to 51800 are nut numbers
1801 to 2000 and 51801 to 52000 are roller numbers
2001 to 50000 and 52001 to 140000 and 142001 to 190000 are Sewing Machine Parts, 190001 and upward are numbers of Electrical Parts.

The figures in the second column refer only to the plates, illustrating the parts, and are NOT TO BE USED in ordering.

Parts marked with an asterisk (*) are furnished only when repairs are made at the factory.

7

LIST OF PARTS COMPLETE
FOR

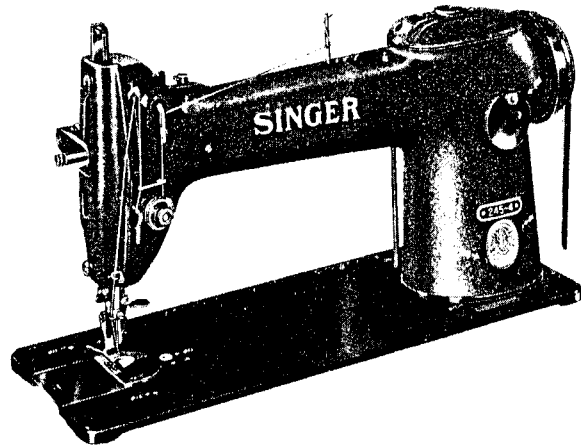

MACHINE No. 245-4

FOR SEWING AND TRIMMING LIGHT, MEDIUM AND HEAVY FABRICS. HAS VERTICAL TRIMMER THAT TRIMS FROM 1/16 INCH TO 1/4 INCH, FROM THE LINE OF STITCHING. NEEDLE BAR STROKE: 1-13/64 INCHES. PRESSER BAR LIFT 5/16 INCH. MAXIMUM STITCH: 5 TO THE INCH. SPEED: 3500 DEPENDING ON MATERIALS USED AND OPERATIONS PERFORMED.

No.	Plate	Name
*144835	-----	Arm with 11119, 144752, 144753 and 144754. NOTE: Due to the accuracy required for gear alignment, Arm cannot be supplied separately and can only be sent out as a unit, Arm and Bed assembled.
8582	24030	Arm Dowel Pin (2)
50608R	24030	Arm Hole Plug Screw (back of arm).....
68350	24030	Arm Oil Cup (spring lid) for oiling Arm Shaft (horizontal) Front Bearing.....
56006	24030	Arm Oil Cup (spring lid) Oil Pad
54897	24030	Arm Oil Cup (ball type) for oiling Arm Shaft (horizontal) Back Bearing.....
144752	24030	Arm Oil Tube for oiling Oil Wick Holder complete
144753	24030	Arm Oil Tube for oiling Arm Shaft (upright) Bearing (lower).....
144754	24030	Arm Oil Tube for oiling Rotating Hook Shaft (back) Bearing.....
11119	24030	Arm Oil Tube with 52045, for oiling Needle Bar Crank (eccentric) Sleeve.....
52045	24030	Arm Oil Tube Packing (cotton) for 11119 ..

No.	Plate	Name
140332E	24030	Arm Screw (right) (2).....
868E	24030	Arm Screw (left) (2).....
144836	24030	Arm Shaft (horizontal).....
144885	-----	Arm Shaft (horizontal) 144836 with 144839, 144884 and two 127315.....
144758	24030	Arm Shaft (horizontal) Bushing (center) with 52263 and 144759.....
52263	24030	Arm Shaft (horizontal) Bushing (center) Oil Pad (felt).....
144759	24030	Arm Shaft (horizontal) Bushing (center) Oil Wick.....
140296AL	24030	Arm Shaft (horizontal) Bushing (center) Set Screw.....
127315	24030	Arm Shaft (horizontal) Counterbalance with 858AL (2).....
858AL	24030	Arm Shaft (horizontal) Counterbalance Set Screw (2).....
144761	24030	Arm Shaft (horizontal) Flanged Bushing (back) with 52289 and 144762.....
52289	24030	Arm Shaft (horizontal) Flanged Bushing (back) Oil Pad (felt).....
144762	24030	Arm Shaft (horizontal) Flanged Bushing (back) Oil Pad Wick.....
140297AL	24030	Arm Shaft (horizontal) Flanged Bushing (back) Set Screw.....
144839	24030	Arm Shaft (horizontal) Flanged Bushing (front) with 144833, 144834 and two 52289.
52289	24030	Arm Shaft (horizontal) Flanged Bushing (front) Oil Pad (felt) (2).....
144834	24030	Arm Shaft (horizontal) Flanged Bushing (front) Oil Pad Retainer.....
44833	24030	Arm Shaft (horizontal) Flanged Bushing (front) Oil Wick.....
140331AL	24030	Arm Shaft (horizontal) Flanged Bushing (front) Set Screw.....
144E	24030	Arm Shaft (horizontal) Screw.....
144765	24030	Arm Shaft (upright).....
143014	24030	Arm Shaft (upright) Bevel Gear (lower) right hand spiral with two 1259AL.....
1259AL	24030	Arm Shaft (upright) Bevel Gear (lower) Set Screw (2).....
143015	24030	Arm Shaft (upright) Bevel Gear (upper) left hand spiral with two 1259AL.....
1259AL	24030	Arm Shaft (upright) Bevel Gear (upper) Set Screw (2).....
144767	24030	Arm Shaft (upright) Bushing (lower) with 52280 and 144768.....
52280	24030	Arm Shaft (upright) Bushing (lower) Oil Pad (felt).....
144768	24030	Arm Shaft (upright) Bushing (lower) Oil Wick (braided cotton).....
140298AL	24030	Arm Shaft (upright) Bushing (lower) Set Screw.....
144770	24030	Arm Shaft (upright) Bushing (upper) with 52280 and 144768.....

No.	Plate	Name
52280	24030	Arm Shaft (upright) Bushing (upper) Oil Pad (felt).....
144768	24030	Arm Shaft (upright) Bushing (upper) Oil Wick (braided cotton).....
140298AL	24030	Arm Shaft (upright) Bushing (upper) Set Screw.....
144771	24030	Arm Side Cover (front).....
50684W	24030	Arm Side Cover Thumb Screw.....
52239	24032	Arm Spool Pin and Thread Eyelet.....
8879	24032	Arm Spool Pin Washer (cloth).....
144773	24031	Arm Top Cover with 144777 and 144778, for 144779.....
144775	24031	Arm Top Cover with 144777 and 144778, for 144780.....
144776	24031	Arm Top Cover Gasket (cork).....
144777	24031	Arm Top Cover Oil Tube (long) with 52184 for oiling Feed Lifting Rock Shaft Connecting Rod.....
144778	24031	Arm Top Cover Oil Tube (short) with 52184 for oiling Feed Rock Shaft Connecting Rod
52184	-----	Arm Top Cover Oil Tube Packing (wick) (2).....
51369R	24031	Arm Top Cover Screw (2).....
143244	24031	Arm Top Cover Spool Pin with Spool Rest, 3-1/2 in. long for 144780.....
143376	24031	Arm Top Cover Stitch Regulator Plunger...
140317X	24031	Arm Top Cover Stitch Regulator Plunger Hole Plug Screw for plugging the Plunger hole when the Plunger is removed to prevent tampering with the Stitch Set
		NOTE: No. 140317X is not regularly furnished with this Machine.
143377	24031	Arm Top Cover Stitch Regulator Plunger Retainer.....
64519	24031	Arm Top Cover Stitch Regulator Plunger Spring.....
144779	24031	Arm Top Cover with Stitch Regulator Plunger complete, Nos. 64519, 143376, 143377 and 144773.....
		NOTE: No. 144779 is regularly furnished with this Machine.
144780	24031	Arm Top Cover with Stitch Regulator Plunger complete, when a longer spool Pin is required, Nos. 64519, 143244, 143376, 143377 and 144775.....
*144781	-----	Bed.....
		NOTE: Due to the accuracy required for gear alignment, Bed cannot be supplied separately and can only be sent out as a unit, Arm and Bed assembled.
12431	24032	Bed Slide.....
4307	24032	Bed Slide Spring.....
725X	24032	Bed Slide Spring Screw (2).....
12432	24032	Bed Slide complete, Nos. 4307, 12431 and two 725J.....

No.	Plate	Name
144827	-----	Combination of Feed and Stitch Regulator Parts Nos. 143015, 143036, 143087, 143134, 144785, 144788 and 147126.
144840	24032	Face Plate
52053	24032	Face Plate Thread Guard (lower)
226J	24032	Face Plate Thread Guard (lower) Screw ...
52170	24032	Face Plate Thread Guard (upper)
226J	24032	Face Plate Thread Guard (upper) Screw ...
144841	24032	Face Plate complete, Nos. 52053, 52170, 144840 and two 226J
51714W	24032	Face Plate Thumb Nut (2)
140373AL	24032	Face Plate Thumb Nut Screw Stud (2)
143030	24035	Feed Bar
		NOTE: No. 143030 is regularly furnished with this Machine.
51220AL	24035	Feed Bar Adjusting Screw (2)
1607C	24035	Feed Bar Adjusting Screw Lock Nut (2) ...
143185	24035	Feed Bar Body with two each 1607C and 51220AL
704C	24035	Feed Bar Body Screw
143186	24035	Feed Bar Shank
143187	24035	Feed Bar (tilting, adjustable) complete, Nos. 704C, 143185 and 143186
313C	24035	Feed Bar Screw Center (2)
56813	-----	Feed Bar Screw Center 313C with 1519J (2)
1519J	24035	Feed Bar Screw Center Nut (2)
149025	24032	Feed Dog, 9 teeth (12 teeth to the inch) for 127036 and 127040
50117AL	24032	Feed Dog Screw (2)
147125	-----	Feed Eccentric
147126	24030	Feed Eccentric 147125 with 143035
143035	-----	Feed Eccentric Body with 1375AL and two 1036AL
		NOTE: Nos. 143035 and 147125 are not supplied separately, when required order No. 147126.
1375AL	24030	Feed Eccentric Body Position Screw
1036AL	24030	Feed Eccentric Body Set Screw (2)
140256AL	24030	Feed Eccentric Stop Screw (7 stitch)
		NOTE: No. 140256AL is regularly furnished with this Machine.
140257AL	24030	Feed Eccentric Stop Screw (5-1/2 stitch) ..
140258AL	24030	Feed Eccentric Stop Screw (14 stitch)
143036	24030	Feed Lifting Eccentric and Arm Shaft (horizontal) Bevel Gear (right hand spiral) with 1259AL, 140333AL and 143088
140333AL	24030	Feed Lifting Eccentric Position Screw
1259AL	24030	Feed Lifting Eccentric Set Screw
144783	24035	Feed Lifting Rock Shaft
144784	-----	Feed Lifting Rock Shaft complete, Nos. 52265 and 144783
144785	24030	Feed Lifting Rock Shaft Connecting Rod
140230C	24030	Feed Lifting Rock Shaft Connecting Rod Hinge Screw

No.	Plate	Name
1518J	24030	Feed Lifting Rock Shaft Connecting Rod Hinge Screw Nut
52265	24035	Feed Lifting Rock Shaft Crank with 157R and 52267
157R	24035	Feed Lifting Rock Shaft Crank Clamping Screw
52266	24035	Feed Lifting Rock Shaft Crank Slide Block ..
52267	-----	Feed Lifting Rock Shaft Crank Slide Block 52266 with 125060
125060	24035	Feed Lifting Rock Shaft Crank Slide Block Stud
50191C	24035	Feed Lifting Rock Shaft Screw Center (2) ..
52097	-----	Feed Lifting Rock Shaft Screw Center 50191C with 1513J (2)
1513J	24035	Feed Lifting Rock Shaft Screw Center Nut (2)
144786	24035	Feed Rock Shaft
144787	-----	Feed Rock Shaft complete, Nos. 144786 and 144789
144788	24030	Feed Rock Shaft Connecting Rod
140230C	24030	Feed Rock Shaft Connecting Rod Hinge Screw
1518J	24030	Feed Rock Shaft Connecting Rod Hinge Screw Nut
144789	24035	Feed Rock Shaft Crank with 157J
157J	24035	Feed Rock Shaft Crank Clamping Screw
50191C	24035	Feed Rock Shaft Screw Center (2)
52097	-----	Feed Rock Shaft Screw Center 50191C with 1513J (2)
1513J	24035	Feed Rock Shaft Screw Center Nut (2)
144790	24030	Gear Case (lower) (two pieces) with 140184E, 142005 and three 145E
142005	24030	Gear Case (lower) Alemite Fitting
140184E	24030	Gear Case (lower) Plug Screw
145E	24030	Gear Case (lower) Screw (3)
144791	24030	Gear Case (upper) (two pieces) with 50668E, 50669E, 140184E and 142005
142005	24030	Gear Case (upper) Alemite Fitting
140184E	24030	Gear Case (upper) Plug Screw
50668E	24030	Gear Case (upper) Screw (long)
50669E	24030	Gear Case (upper) Screw (short)
127026	24033	Knife (narrow)
127027	24033	Knife (wide)
620AL	24033	Knife Adjusting Screw
144842	24033	Knife Bar with 2301
24431	24033	Knife Bar Crank with 191C
1162C	24033	Knife Bar Crank Coupling Pin
1564J	24033	Knife Bar Crank Coupling Pin Head
2297	24033	Knife Bar Crank Coupling Pin Spring
2022	24033	Knife Bar Crank Pin
191C	24033	Knife Bar Crank Set Screw
24432	-----	Knife Bar Crank complete, Nos. 1162C, 1564J, 2297 and 24431
127028	24033	Knife Bar Driving Crank (forked)
16564	24033	Knife Bar Driving Crank Bracket

No.	Plate	Name
127029	24033	Knife Bar Driving Crank Bracket complete, Nos. 2022, 16564, 24432 and 127028.....
647C	24033	Knife Bar Driving Crank Bracket Screw (2)
144843	24033	Knife Bar Lifting Spring
144844	24033	Knife Bar Lifting Spring Case
144849	24033	Knife Bar Lifting Spring Guide with 144846 and 144847
144846	24033	Knife Bar Lifting Spring Guide Bracket.....
228J	24033	Knife Bar Lifting Spring Guide Bracket Screw
144847	24033	Knife Bar Lifting Spring Guide Pin.....
2301	24033	Knife Bar Stop Pin
144848	-----	Knife Bar complete, Nos. 228J, 24109, 52108, 144842, 144849 and three 50117AL.
52108	24033	Knife Holder with 620AL, 2291 and two 223J
24109	24033	Knife Holder Handle
50117AL	24033	Knife Holder Handle Screw.....
50117AL	24033	Knife Holder Screw (2).....
223J	24033	Knife Screw (2)
2291	24033	Knife Screw Washer.....
143363	24031	Machine Pulley (disc power) "V" belt groove (outside diam. of belt groove 2.9") with two 51283AL
51283AL	24031	Machine Pulley Set Screw (2)
127135	24034	Needle Bar (hollow) with 140239AL
127137	-----	Needle Bar (hollow) 127135 with 127136 ...
127279	24034	Needle Bar Bushing (lower)
1133AL	24034	Needle Bar Bushing (lower) Set Screw.....
52111	24034	Needle Bar Bushing (upper)
127231	24034	Needle Bar Connecting Link with 52207....
144819	-----	Needle Bar Connecting Link 127231 with 143057
775E	24034	Needle Bar Connecting Link Cap Screw....
52207	24034	Needle Bar Connecting Link Lubricating Pad (wood)
143057	24034	Needle Bar Connecting Stud with 140706C.
140706C	24034	Needle Bar Connecting Stud Clamping Screw
143058	24034	Needle Bar Connecting Stud Slide Block....
144883	-----	Needle Bar Crank (eccentric) with 1036AL, 1037AL, 1065AL and 140659AL.....
144884	24030	Needle Bar Crank (eccentric) 144883 with 127032
*127032	-----	Needle Bar Crank (eccentric) Sleeve.....
1065AL	24030	Needle Bar Crank Position Screw
140659AL	24030	Needle Bar Crank Position Screw Clamping Screw
127136	24034	Needle Bar Thread Guide
140239AL	24034	Needle Set Screw.....
56015	24030	Oil Tube for 144793
144793	24030	Oil Tube Bracket with 56015, for oiling Arm Shaft (upright) Bearing (upper)
50156AL	24030	Oil Tube Bracket Screw.....
143197	24030	Oil Wick for oiling Thread Take-up Lever, Needle Bar Connecting Link Thread Take-up Link and Thread Take-up Lever Hinge Bearing for 144818 (2)

No.	Plate	Name
144818	24030	Oil Wick Holder complete, Nos. 144796 and two 143197.....
144796	24030	Oil Wick Holder Cap for 144818.....
140232J	24030	Oil Wick Holder Screw.....
12391	24034	Presser Bar (hollow).....
143385	24034	Presser Bar Bushing (lower).....
52338	24034	Presser Bar Guide Bracket with 223C and 453AL
453AL	24034	Presser Bar Guide Bracket Set Screw.....
2062	24034	Presser Bar Lifter.....
15486	24034	Presser Bar Lifter Hinge Stud.....
448AL	24034	Presser Bar Lifter Hinge Stud Set Screw ...
12327	24034	Presser Bar Lifting and Releasing Lever Bracket.....
127108	24034	Presser Bar Spring
11170	24034	Presser Bar Spring Washer
127033	24034	Presser Foot for 1/16" to 11/64" trim, in steps of 1/64"
		NOTE: No. 127033, 1/8" trim and No. 127034, 3/16" trim, are sent with this machine unless other trims are specified on order.
127034	24034	Presser Foot for 3/16" trim to 1/2" trim, in steps of 1/64"
140390AL	24034	Presser Foot Screw
50373W	24034	Pressure Regulating Thumb Screw.....
144828	24034	Rotating Hook with three 1253AL
144829	-----	Rotating Hook 144828 with 270083 and four 1053E.....
144830	-----	Rotating Hook 144829 with 40274, 143346 and three 1367E.....
144832	24034	Rotating Hook 144830 with 52237.....
40264	24034	Rotating Hook Bobbin (3)
52235	24034	Rotating Hook Bobbin Case
52236	-----	Rotating Hook Bobbin Case 52235 with 591F, 1380E and 40394
40392	24034	Rotating Hook Bobbin Case Latch
125320	24034	Rotating Hook Bobbin Case Latch Lever
2974	24034	Rotating Hook Bobbin Case Latch Lever Fulcrum Pin.....
2975	24034	Rotating Hook Bobbin Case Latch Spring....
592E	24034	Rotating Hook Bobbin Case Latch Stop Screw
40393	24034	Rotating Hook Bobbin Case Hinge, Nos. 2974, 40392 and 125320.....
143346	24034	Rotating Hook Bobbin Case Holder
52018	24035	Rotating Hook Bobbin Case Holder Position Bracket.....
704J	24035	Rotating Hook Bobbin Case Holder Position Bracket Screw.....
591F	24034	Rotating Hook Bobbin Case Tension Regulating Screw
40394	24034	Rotating Hook Bobbin Case Tension Spring..
1380E	24034	Rotating Hook Bobbin Case Tension Spring Screw
52237	24034	Rotating Hook Bobbin Case complete, Nos. 592E, 2975, 40393 and 52236

No.	Plate	Name
40274	24034	Rotating Hook Section.....
1367E	24034	Rotating Hook Section Screw (3).....
1253AL	24034	Rotating Hook Set Screw (3).....
144797	24035	Rotating Hook Shaft
144798	24035	Rotating Hook Shaft Bevel Gear (left hand spiral) with two 1259AL
1259AL	24035	Rotating Hook Shaft Bevel Gear Set Screw (2)
144800	24035	Rotating Hook Shaft Bushing (back) with 52280 and 144801.....
52280	24035	Rotating Hook Shaft Bushing (back) Oil Pad (felt)
144801	24035	Rotating Hook Shaft Bushing (back) Oil Wick (braided cotton).....
140261AL	24035	Rotating Hook Shaft Bushing (back) Set Screw
144803	24035	Rotating Hook Shaft Bushing (front) with 144801 and two 52280
52280	24035	Rotating Hook Shaft Bushing (front) Oil Pad (felt) (2)
144801	24035	Rotating Hook Shaft Bushing (front) Oil Wick (braided cotton).....
142008	24035	Rotating Hook Shaft Bushing (front) Oil Cup.....
140261AL	24035	Rotating Hook Shaft Bushing (front) Set Screw
270083	24034	Rotating Hook Thread Guard.....
1053E	24034	Rotating Hook Thread Guard Screw (4).....
52115	24034	Slack Thread Regulator
223C	24034	Slack Thread Regulator Set Screw.....
143085	24030	Stitch Regulator.....
143134	-----	Stitch Regulator 143085 with 140549E, 143086 and 143378
143086	24030	Stitch Regulator Locking Slide
143087	24030	Stitch Regulator Locking Slide Ratchet Wheel
143088	-----	Stitch Regulator Locking Slide Ratchet Wheel Pin
143378	24030	Stitch Regulator Locking Slide Spring.....
140549E	24030	Stitch Regulator Locking Slide Spring Screw.....
2102	24032	Tension Disc (2)
1560C	24032	Tension Regulating Thumb Nut.....
32572	24032	Tension Releasing Disc
43944	24032	Tension Releasing Lever.....
12398	24032	Tension Releasing Lever Hinge Pin
12329	24032	Tension Releasing Lever Spring
32574	24032	Tension Releasing Pin.....
2103	24032	Tension Spring.....
50304C	24032	Tension Stud
52098	-----	Tension Stud 50304C with 1560C
50305C	24032	Tension Stud Set Screw
52397	24032	Tension complete, Nos. 2103, 32572, 32574, 52083, 52098, 52394 and two 2102.....
143135	24032	Thread Guard (side of arm).....
52454	24032	Thread Retainer
624AL	24032	Thread Retainer Set Screw.....

No.	Plate	Name
144852	-----	Thread Take-up complete, Nos. 143097, 144808 and 144853.....
52021	24034	Thread Take-up Crank
144853	-----	Thread Take-up Crank 52021 with 775E, 143058 and 144819.....
1036AL	24030	Thread Take-up Crank Position Screw.....
1037AL	24030	Thread Take-up Crank Set Screw
144807	-----	Thread Take-up Lever with 52130.....
52023	24034	Thread Take-up Lever Hinge Stud.....
143096	24034	Thread Take-up Lever Link.....
143097	24034	Thread Take-up Lever Link Hinge Stud.....
435AL	24034	Thread Take-up Lever Link Hinge Stud Set Screw.....
52130	24034	Thread Take-up Lever Thread Eyelet Bushing.....
144808	-----	Thread Take-up Lever complete, Nos. 52023, 143096 and 144807.....
52394	24032	Thread Take-up Spring
52083	24032	Thread Take-up Spring Regulator with 50305C
443AL	24032	Thread Take-up Spring Regulator Set Screw
5729	24032	Throat Plate Body.....
142032	24032	Throat Plate Cutting Bar for 1/16" to 1/4" Trimming margin, for 127036
	NOTE:	No. 142032, 3/16" Trimming margin is sent with this Machine unless another margin is specified on order. When ordering state Trimming margin required.
52131	-----	Throat Plate Cutting Bar for 1/16" to 1/4" Trimming margin, for 127040
	NOTE:	When ordering No. 52131 or 142032, state required distance of trimmed edge from seam. When ordering state Trimming margin required.
578D	24032	Throat Plate Cutting Bar Screw (2).....
127035	24032	Throat Plate Slide
578D	24032	Throat Plate Slide Adjusting Screw.....
127036	24032	Throat Plate (small needle hole) complete, for 1/16" to 1/4" trim, in steps of 1/64", for 127025, Nos. 5729, 127035, 142032 and three 578D
	NOTE:	No. 127036, 1/8" Trimming margin is sent with this Machine, unless another margin is specified on order. When ordering state size of trim required.
127040	-----	Throat Plate (large needle hole) complete for 1/16" to 1/4" trim, in steps of 1/64", for 127025, Nos. 5729, 52131, 127035 and three 578D
	NOTE:	When ordering No. 127036 or 127040, state required distance of trimmed edge from seam. When ordering state size of trim required.
691AL	24032	Throat Plate Screw (2).....
144809	24023	Drip Pan with four 1" wire nails

ACCESSORIES

No.	Plate	Name
12361	----	Machine Hinge Connection (2).....
41400	24012	Machine Rest Pin, 4" long (wood).....
120342	24012	Oiler (copper plated) with 120343.....
120343	24012	Oiler Spout, 3-1/2" long.....
26026	24012	Screw Driver (large).....
26485	24012	Screw Driver (small).....
8909	24012	Wrench for 1513 and 1518.....
8908	24012	Wrench for 1519.....

BOBBIN WINDERS

BOBBIN WINDER
(Swinging Automatic, Right Hand)
For V-Belt Drive

No.	Plate	Name
259428	23253	Brake (leather).....
259429	23253	Brake Clamp.....
200113F	23253	Brake Clamp Screw.....
259662	23253	Bobbin Winder and Tension Bracket Base...
225453	23253	Frame with 202277 and 259660.....
225454	23253	Frame Hinge Pin.....
202277	23253	Frame Oil Packing (wick).....
259660	23253	Frame Oil Well Washer.....
225455	23253	Frame Spring.....
225456	23253	Frame Spring Plunger.....
259461	23253	Pulley with 200380C.....
200380C	23253	Pulley Set Screw.....
225381	23253	Spindle.....
225444	23253	Stop Latch.....
200056E	23253	Stop Latch Screw.....
225458	23253	Stop Latch Thumb Lever.....
225459	23253	Stop Latch Thumb Lever Hinge Stud.....
225459	23253	Stop Latch Thumb Lever Joint Stud.....
202478	23253	Stop Latch Trip Lever.....
200299X	23253	Stop Latch Trip Lever Hinge Screw.....
225461	23253	Tension Bracket with 201499X.....
200082D	23253	Tension Bracket Screw.....
228026	23253	Tension Bracket Screw Washer.....
2102	23253	Tension Disc (2).....
13710	23253	Tension Spring.....
201499X	23253	Tension Stud.....
201572X	23253	Tension Stud Thumb Nut.....
225462	23253	Tension Bracket complete, Nos. 13710, 201572X, 225461 and two 2102.....

No.	Plate	Name
259462	23253	Bobbin Winder complete, for "V" belt, Nos. 200056E, 200082D, 200113F, 200299X, 202478, 225381, 225444, 225453, 225454, 225455, 225456, 225458, 225462, 228026, 259428, 259429, 259461, 259662 and two each 225459 and wood screws 3/4" No. 12 R. H.....

BOBBIN WINDER
(For Round Belt)

No.	Plate	Name
259428	23253	Brake (leather).....
259429	23253	Brake Clamp.....
200113F	23253	Brake Clamp Screw.....
259430	23253	Bobbin Winder and Tension Bracket Base...
225453	23253	Frame with 202277 and 259660.....
225454	23253	Frame Hinge Pin.....
202277	23253	Frame Oil Packing (wick).....
259660	23253	Frame Oil Well Washer.....
225455	23253	Frame Spring.....
225456	23253	Frame Spring Plunger.....
225368	23253	Pulley with 200380C.....
200380C	23253	Pulley Set Screw.....
225381	23253	Spindle.....
225444	23253	Stop Latch.....
200056E	23253	Stop Latch Screw.....
225458	23253	Stop Latch Thumb Lever.....
225459	23253	Stop Latch Thumb Lever Hinge Stud.....
225459	23253	Stop Latch Thumb Lever Joint Stud.....
202478	23253	Stop Latch Trip Lever.....
200299X	23253	Stop Latch Trip Lever Hinge Screw.....
225461	23253	Tension Bracket with 201499X.....
200082D	23253	Tension Bracket Screw.....
228026	23253	Tension Bracket Screw Washer.....
2102	23253	Tension Disc (2).....
13710	23253	Tension Spring.....
201499X	23253	Tension Stud.....
201572X	23253	Tension Stud Thumb Nut.....
225462	23253	Tension Bracket complete, Nos. 13710, 201572X, 225461 and two 2102.....
259431	23253	Bobbin Winder complete, Nos. 200056E, 200082D, 200113F, 200299X, 202478, 225368, 225381, 225444, 225453, 225454, 225455, 225456, 225458, 225462, 228026, 259428, 259429, 259430 and two each 225459 and wood screws 3/4" No. 12 R. H.B.

FINGER GUARD

No.	Plate	Name
121356	24034	Finger Guard.....

GREASE GUNS

No.	Plate	Name
160907	-----	Grease Gun (5 oz. capacity) for fitting No. 142005.....
121588	24036	Grease Gun (1/2 lb. capacity) for fitting No. 142005.....

KNEE LIFTER PARTS

KNEE LIFTER
For Power Table

No.	Plate	Name
144810	24035	Bell Crank.....
144811	24035	Bell Crank Bracket.....
158R	24035	Bell Crank Bracket Screw (2).....
143104	24035	Bell Crank Hinge Pin.....
144812	-----	Bell Crank complete, Nos. 143104, 144810 and 144811.....
143107	24035	Lifting Lever with 448AL.....
143108	24035	Lifting Lever Connecting Rod.....
1611J	24035	Lifting Lever Connecting Rod Nut.....
1611J	24035	Lifting Lever Connecting Rod Nut Lock Nut.....
143109	24035	Lifting Lever Connecting Rod Swivel.....
802X	24035	Lifting Lever Hinge Screw.....
12241	24034	Lifting Lever Link.....
766E	24034	Lifting Lever Link Hinge Screw.....
16586	24035	Lifting Lever Pin.....
448AL	24035	Lifting Lever Pin Set Screw.....
146610	24035	Lifting Lever Spring.....
2763	22338	Rock Shaft.....
139633	-----	Rock Shaft 2763 with 2770, 6337 and 139623.....
127312	22338	Rock Shaft Hanger (back) with two wood screws 1" No. 10 F. H.....
12242	22338	Rock Shaft Hanger (front) with two wood screws 1" No. 10 F. H.....
2765	22338	Rock Shaft Knee Arm with 1509E.....
2766	22338	Rock Shaft Knee Arm Hub with 356C.....
356C	22338	Rock Shaft Knee Arm Hub Set Screw.....
1509E	-----	Rock Shaft Knee Arm Lock Nut.....
2768	-----	Rock Shaft Knee Arm complete, Nos. 2765, 2766 and 2767.....
2767	22338	Rock Shaft Knee Arm Plate with 356C.....

No.	Plate	Name
356C	22338	Rock Shaft Knee Arm Plate Set Screw.....
6337	22338	Rock Shaft Lifting Bracket with two 356C.....
139623	22338	Rock Shaft Lifting Bracket Hook.....
356C	22338	Rock Shaft Lifting Bracket Hook Set Screw.....
356C	22338	Rock Shaft Lifting Bracket Set Screw.....
2770	22338	Rock Shaft Stop Dog with 140219C.....
140219C	22338	Rock Shaft Stop Dog Set Screw.....
139624	22338	Rock Shaft complete, Nos. 2768, 12242, 127312 and 139633.....
144854	-----	Knee Lifter complete, Nos. 766E, 802X, 12241, 16586, 139624, 143107, 143108, 143109, 144812, 146610 and two each 158R and 1611J.....

KNEE LIFTER

For Foot Power and Individual Motor Stand

No.	Plate	Name
144810	24035	Bell Crank.....
144811	24035	Bell Crank Bracket.....
158R	24035	Bell Crank Bracket Screw (2).....
143104	24035	Bell Crank Hinge Pin.....
144812	-----	Bell Crank complete, Nos. 143104, 144810 and 144811.....
143107	24035	Lifting Lever with 448AL.....
143108	24035	Lifting Lever Connecting Rod.....
1611J	24035	Lifting Lever Connecting Rod Nut.....
1611J	24035	Lifting Lever Connecting Rod Nut Lock Nut.....
143109	24035	Lifting Lever Connecting Rod Swivel.....
802X	24035	Lifting Lever Hinge Screw.....
12241	24034	Lifting Lever Link.....
766E	24034	Lifting Lever Link Hinge Screw.....
16586	24035	Lifting Lever Pin.....
448AL	24035	Lifting Lever Pin Set Screw.....
146610	24035	Lifting Lever Spring.....
2763	22338	Rock Shaft.....
139633	-----	Rock Shaft 2763 with 2770, 6337 and 139623.....
7539	22338	Rock Shaft Hanger with two wood screws 1" No. 10 F. H. (2).....
2765	22338	Rock Shaft Knee Arm with 1509E.....
2766	22338	Rock Shaft Knee Arm Hub with 356C.....
356C	22338	Rock Shaft Knee Arm Hub Set Screw.....
1509E	-----	Rock Shaft Knee Arm Lock Nut.....
2768	-----	Rock Shaft Knee Arm complete, Nos. 2765, 2766 and 2767.....
2767	22338	Rock Shaft Knee Arm Plate with 356C.....
356C	22338	Rock Shaft Knee Arm Plate Set Screw.....
6337	22338	Rock Shaft Lifting Bracket with two 356C.....
139623	22338	Rock Shaft Lifting Bracket Hook.....
356C	22338	Rock Shaft Lifting Bracket Hook Set Screw.....
356C	22338	Rock Shaft Lifting Bracket Set Screw.....
2770	22338	Rock Shaft Stop Dog with 140219C.....

No.	Plate	Name
140219C	22338	Rock Shaft Stop Dog Set Screw.....
139625	22338	Rock Shaft complete, Nos. 2768, 139633 and two 7539.....
144855	-----	Knee Lifter complete, Nos. 766E, 802X, 12241, 16586, 139625, 143107, 143108, 143109, 144812, 146610 and two each 158R and 1611J.....

MACHINE BASE

19219	22309	Bed Frame Cushion (leather) (4).....
158C	22309	Bed Frame Cushion Screw (8).....
19220	22309	Bed Frame Cushion Spring (4).....
19226	22309	Bed Frame Hinge Connection (2).....
19398	-----	Bed Frame Hinge Connection 19226 with 211E and 19397 (2).....
19397	22309	Bed Frame Hinge Connection Cap (2).....
211E	22309	Bed Frame Hinge Connection Cap Screw (2).....
16555	22309	Bed Frame Hinge Plate (2).....
14010	22309	Bed Frame Hinge Plate Rivet (6).....
20067	22309	Bed Frame with two each 16555, 19398, four each 19219, 19220, six each 14010, wood screws 1-1/4" No. 12 and eight 158C.....

THREAD UNWINDER

FOR TWO SPOOLS OR TWO LARGE CONES OF THREAD

No.	Plate	Name
228764	24037	Spool Pin (2).....
228766	24037	Spool Rest with 201254C.....
150203	24037	Spool Rest Cushion (felt) (2).....
228767	24037	Spool Rest Rod.....
201254C	24037	Spool Rest Set Screw.....
228768	24037	Spool Stand.....
228769	24037	Thread Guide (2).....
228770	24037	Thread Guide Holder.....
228774	24037	Thread Guide Rod.....
228776	24037	Thread Unwinder complete, Nos. 228766, 228767, 228768, 228770, 228774, two each 150203, 228764, 228769 and three wood screws 7/8" No. 12.....
27739	24037	Thread Cone (wood) for large cones.....
225390	24037	Thread Cone Holder for inverted cones.....

NOTE: Nos. 27739 and 225390 are used with but not included in 228776.

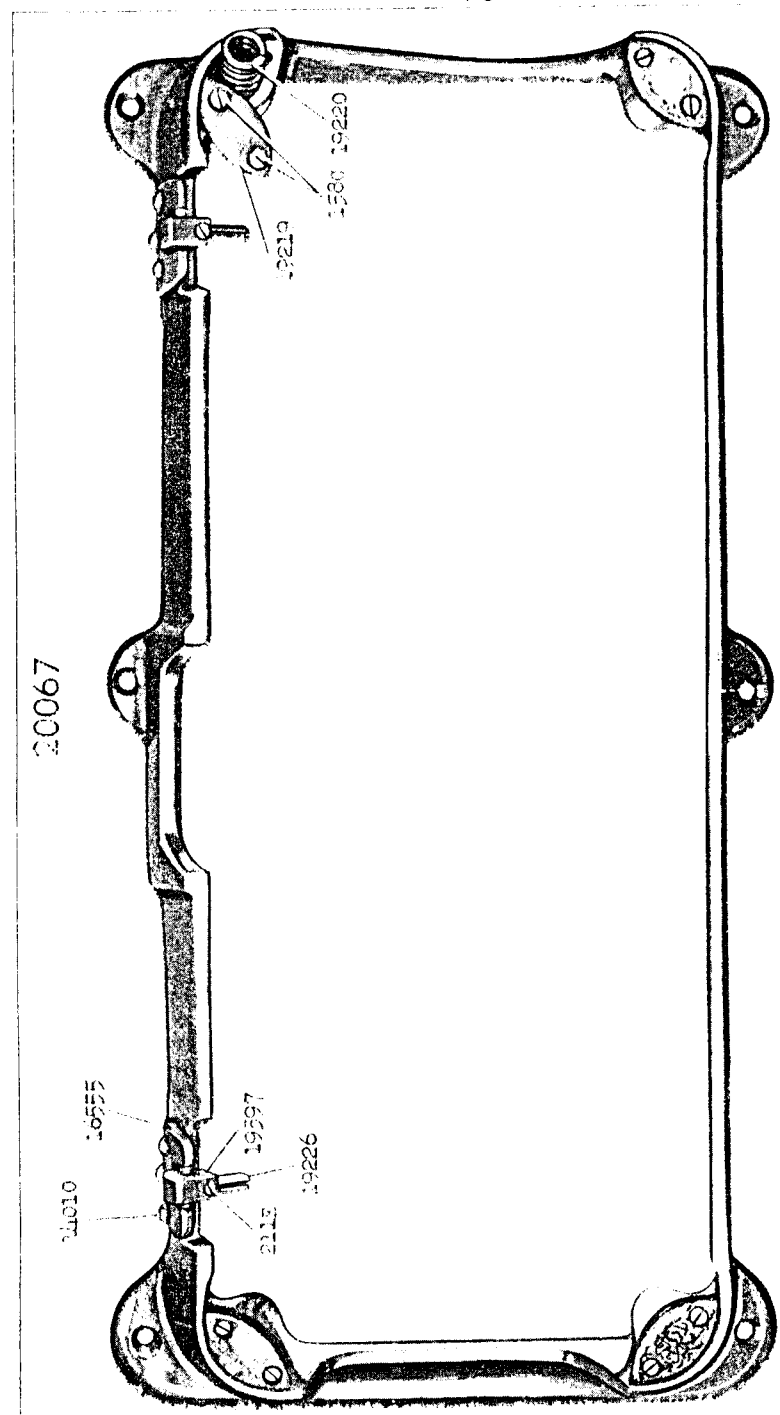

22338 - 1/3

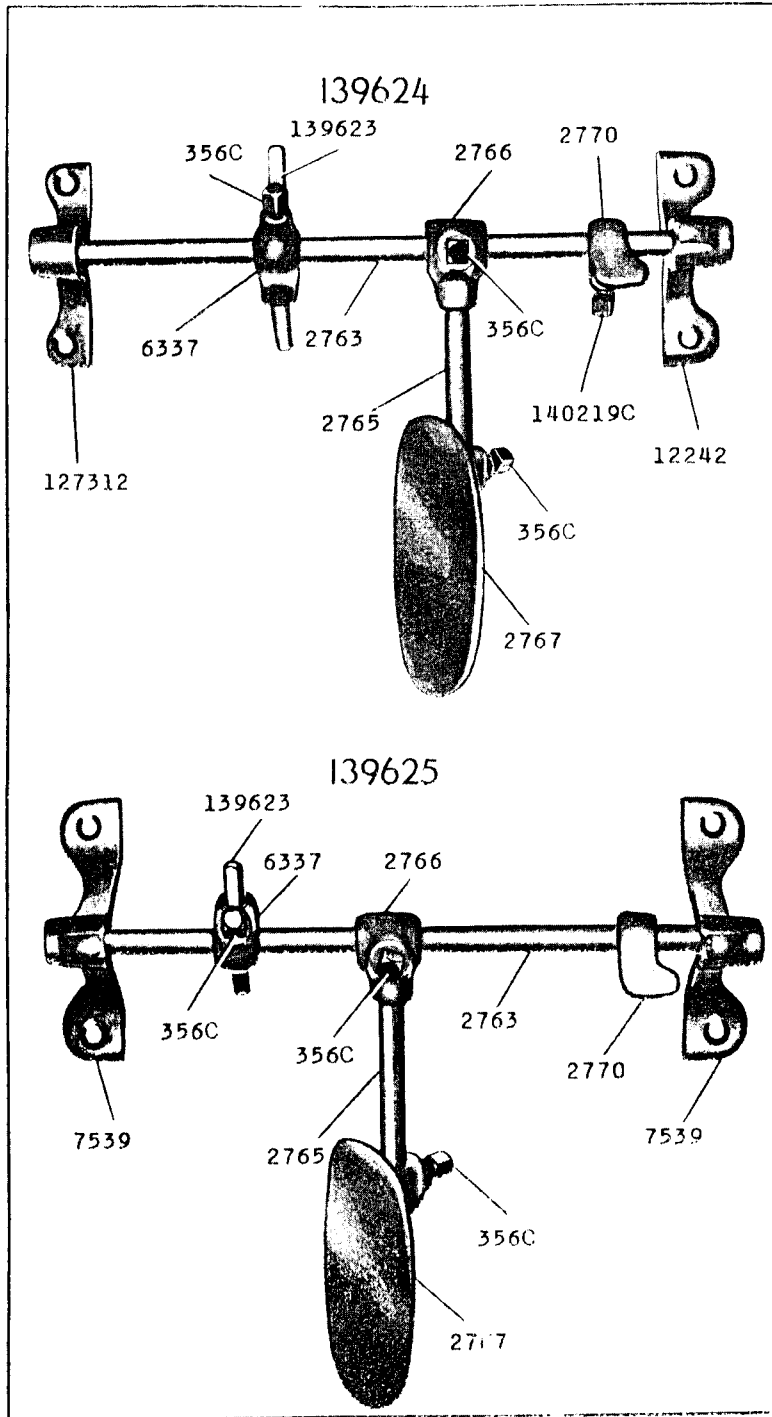

23253 - 3/8

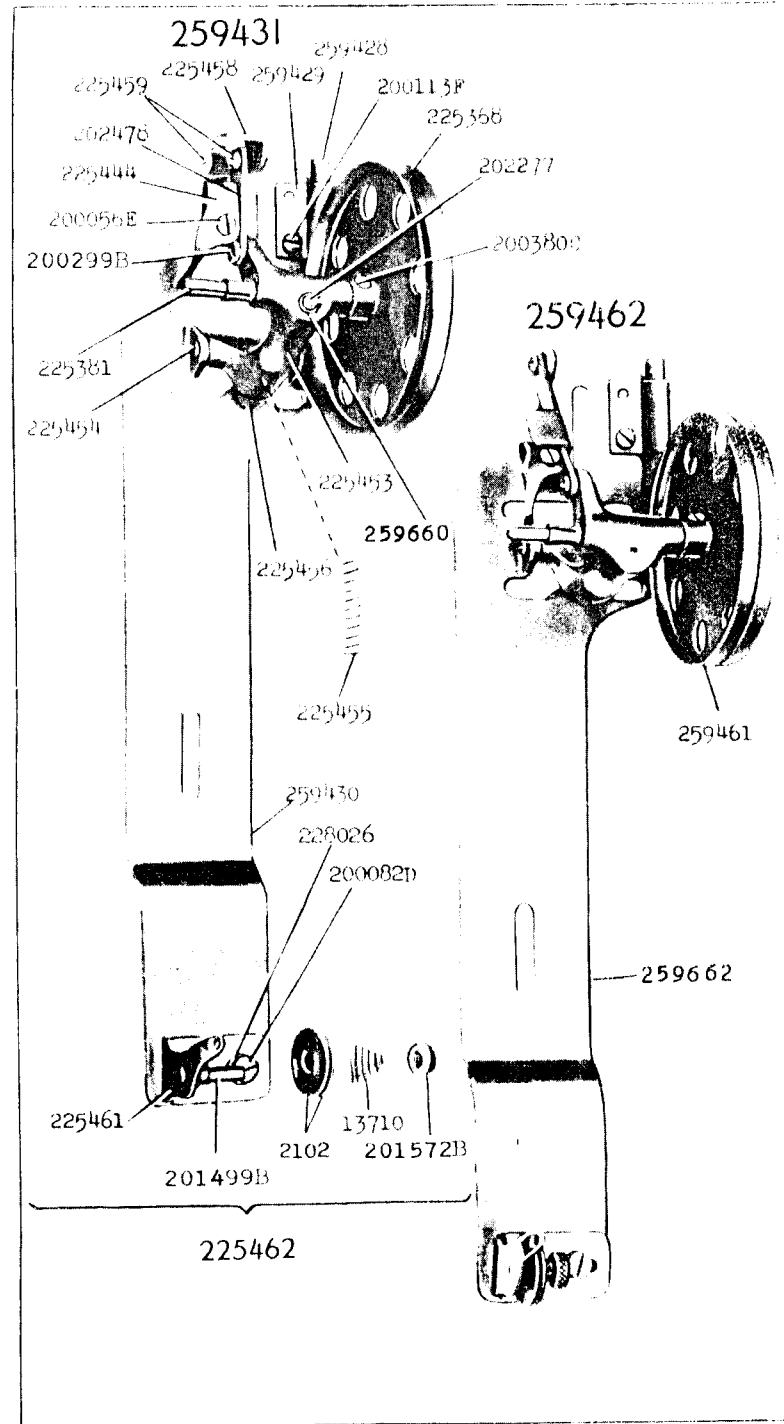

24012 - 2/3

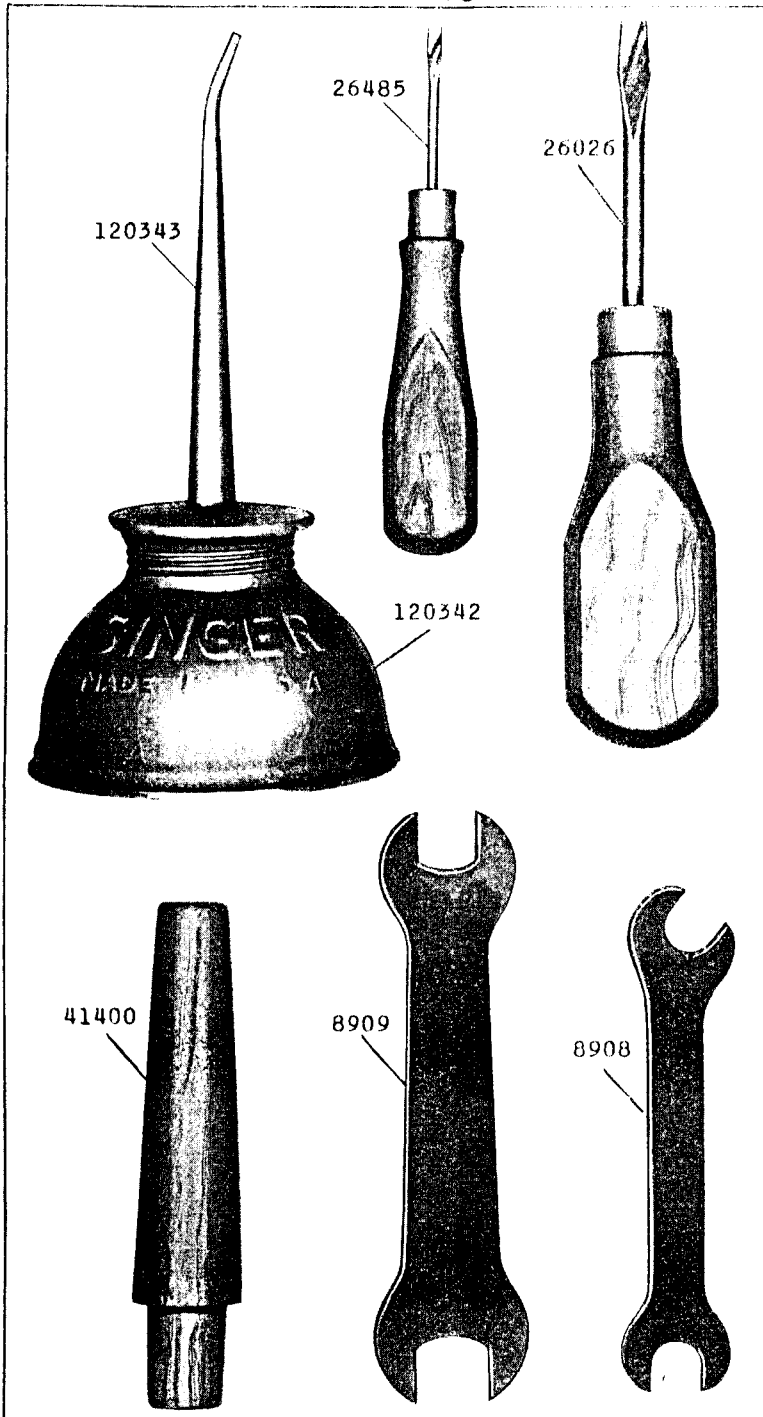

24023 - 1/3

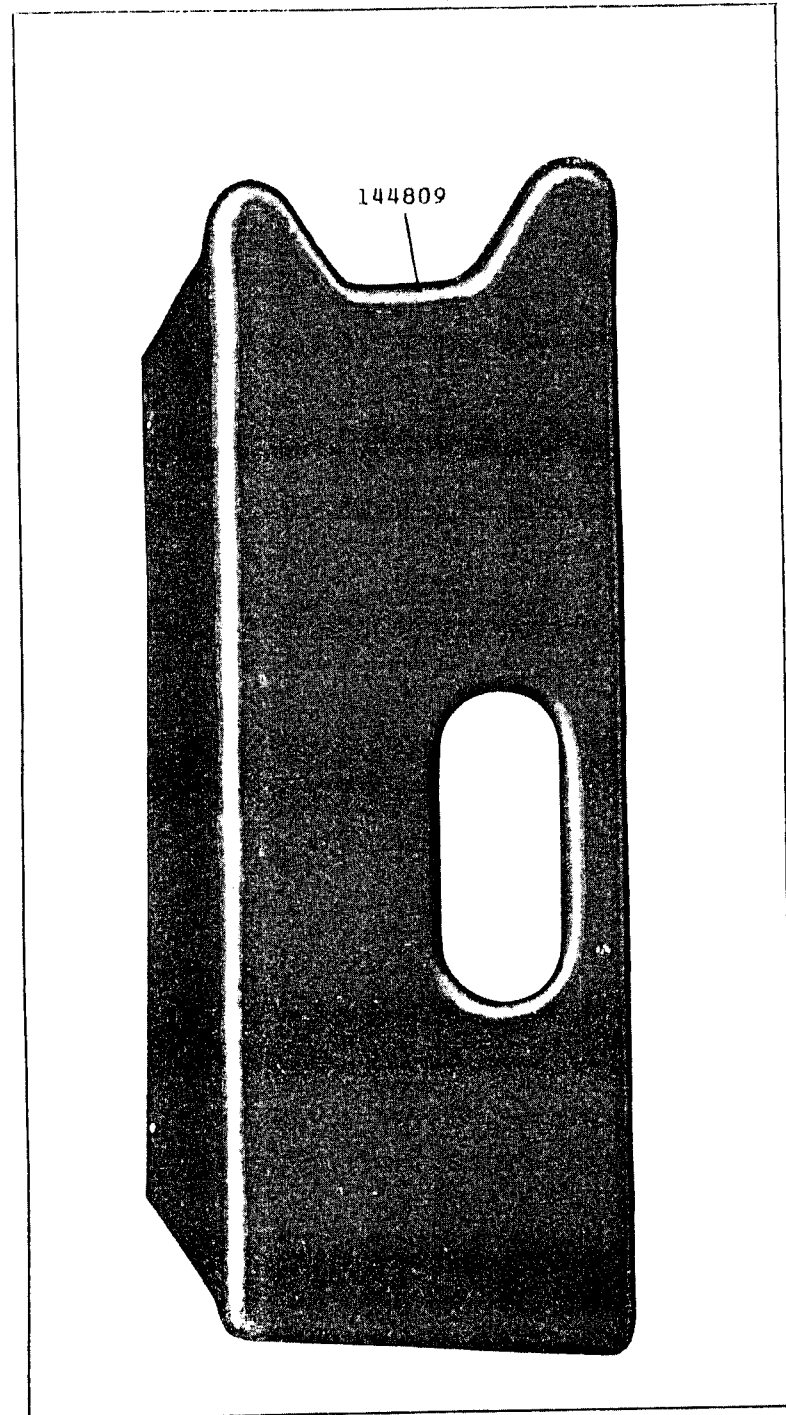

24030-1/3

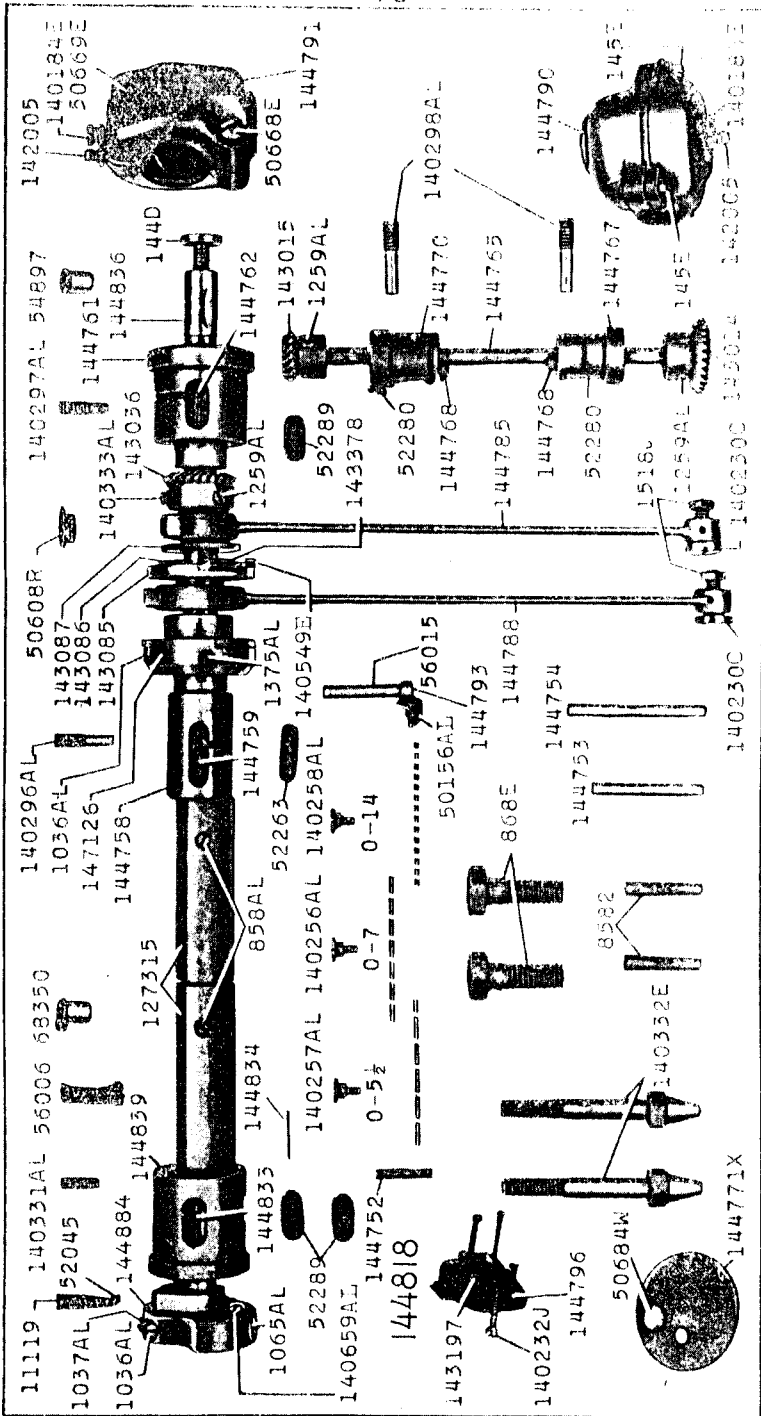

24031-1/2

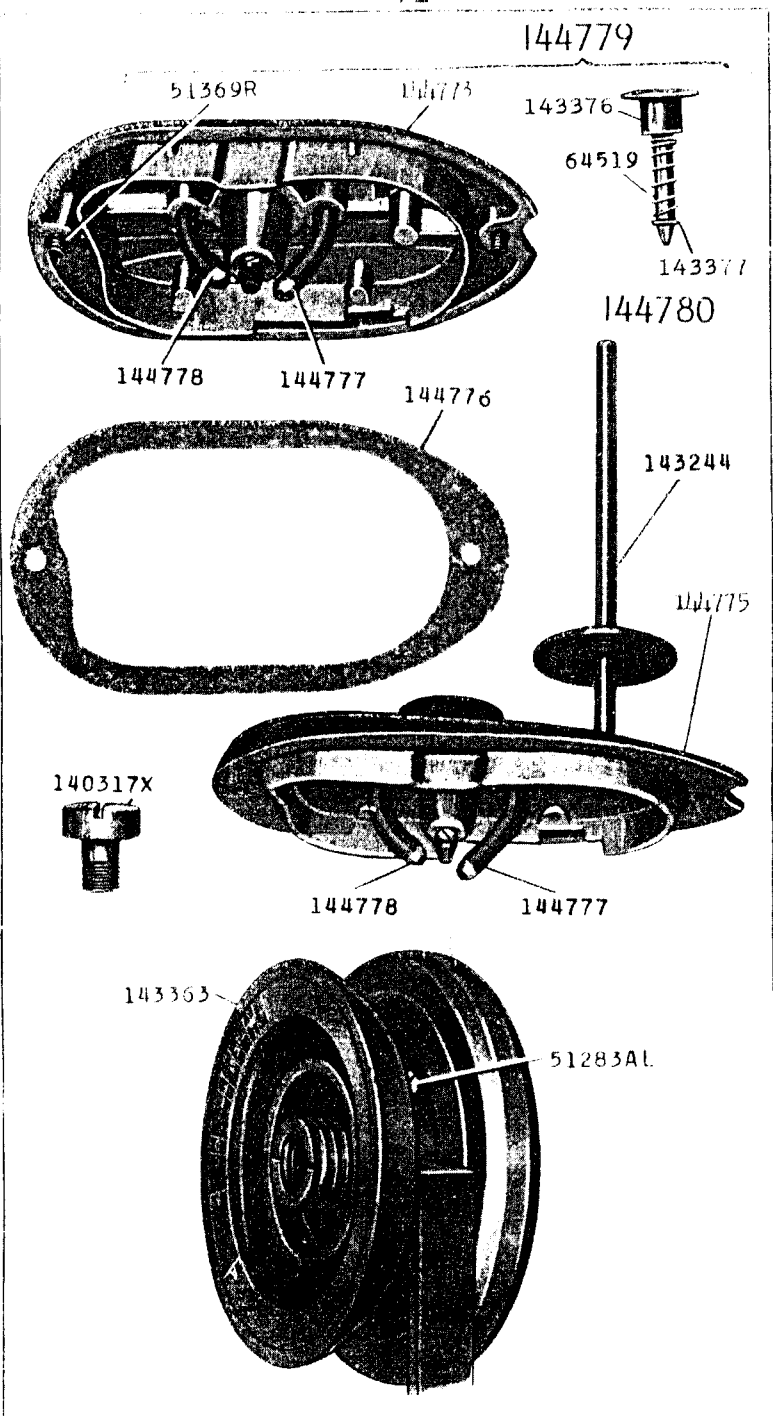

24032-1/2

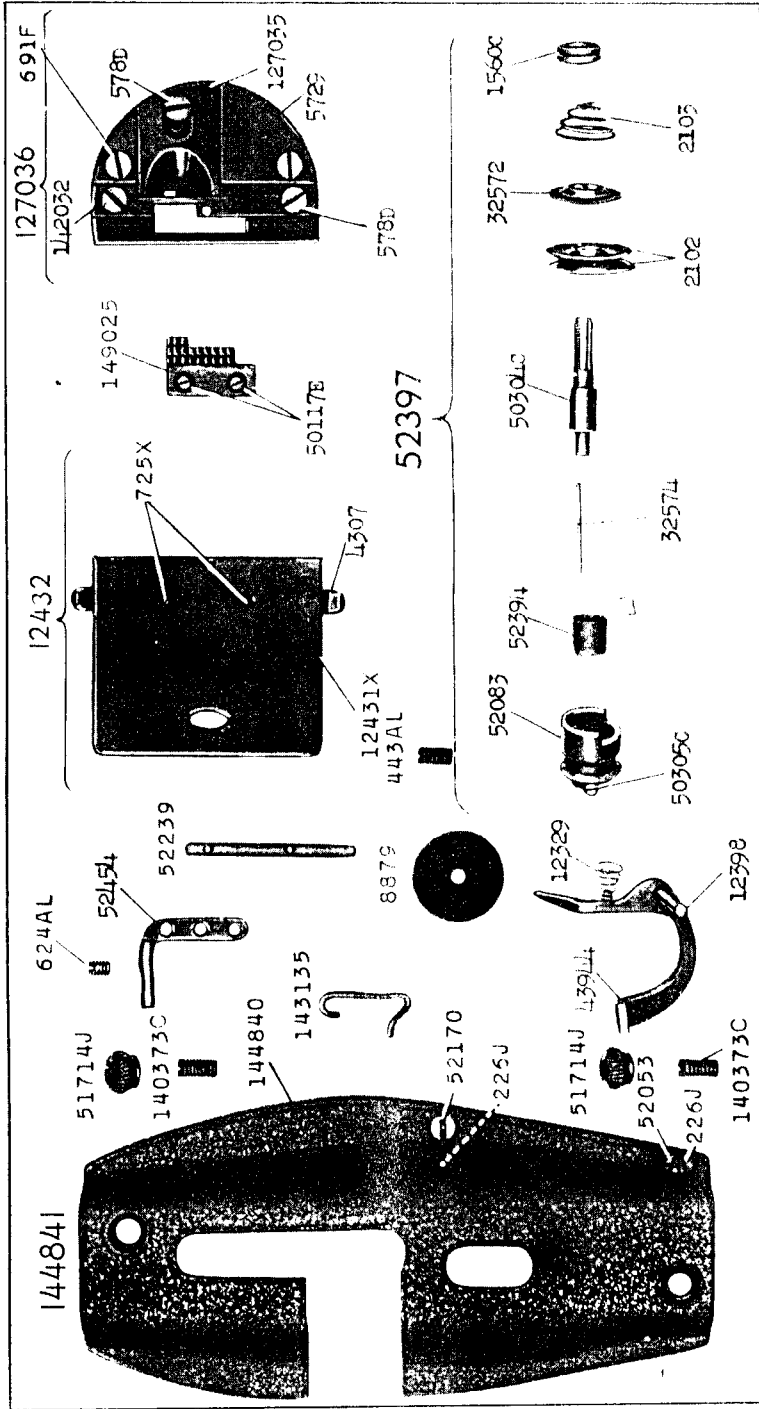

24033-2/3

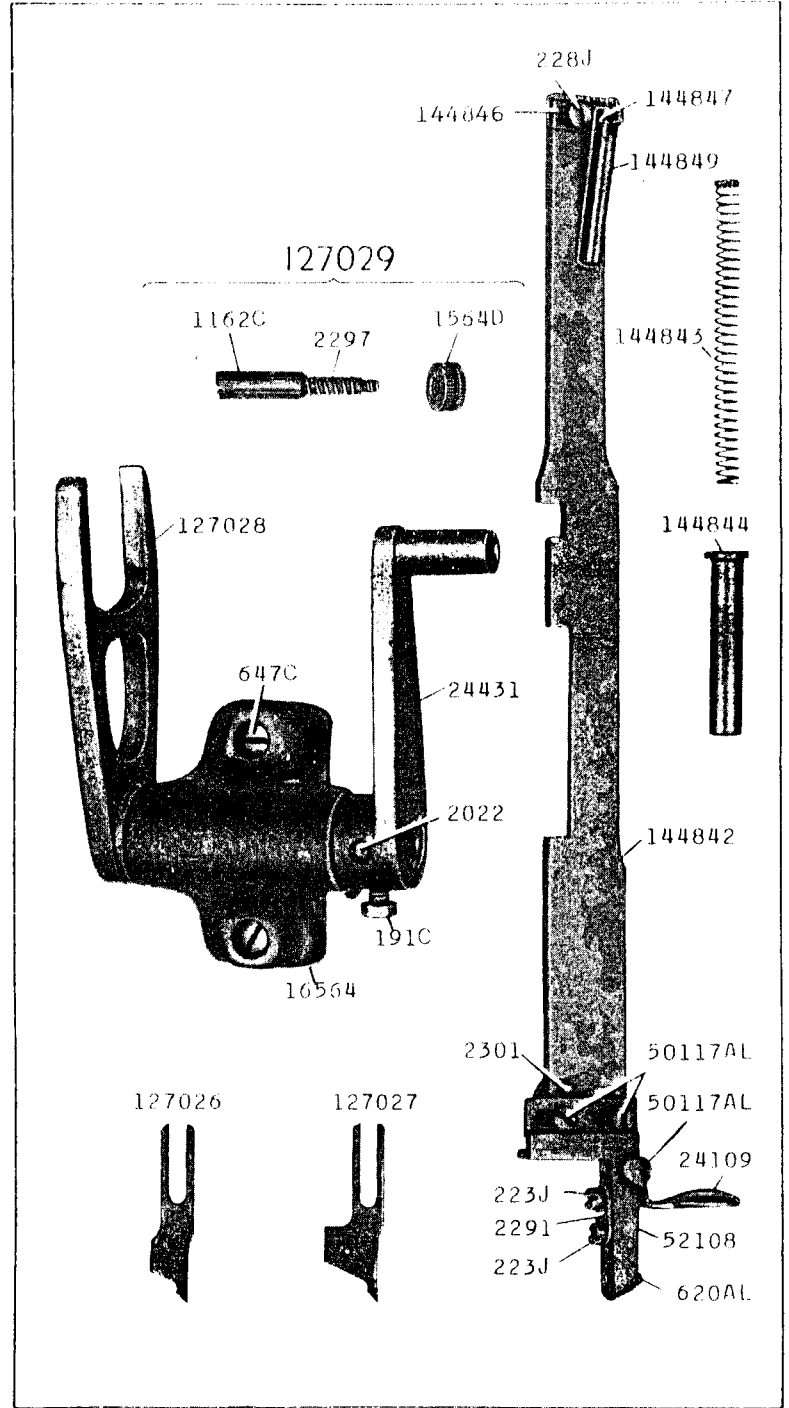

24034-1/2

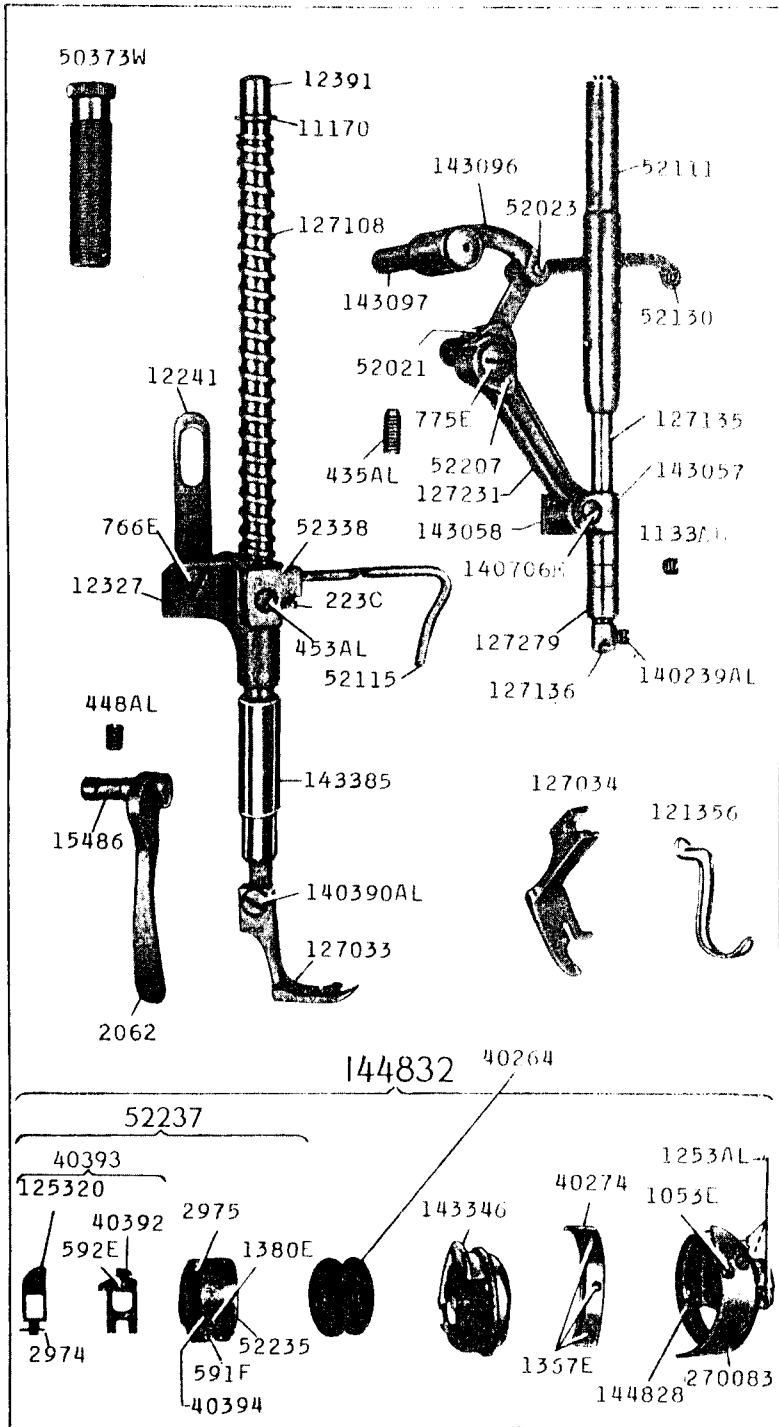

24035-1/3

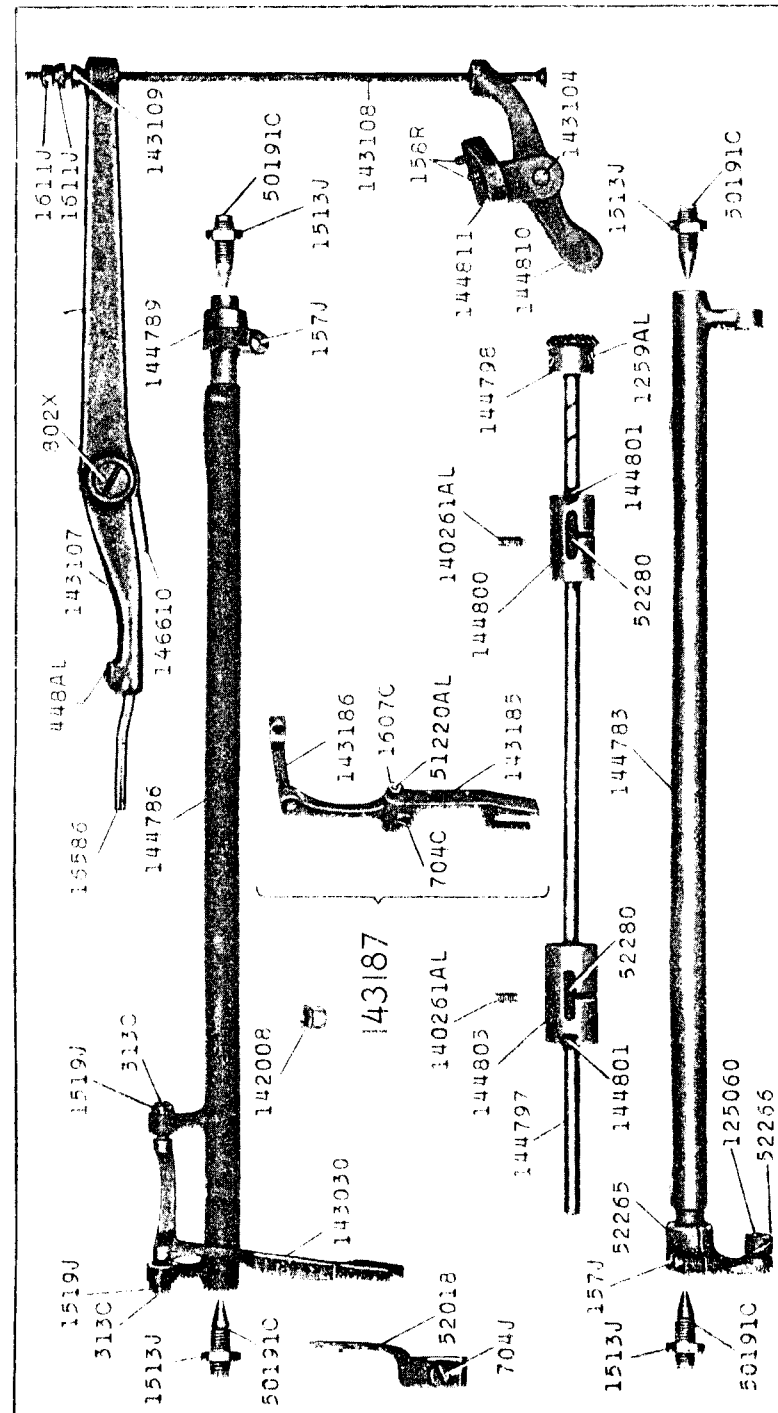

24036-1/2

121588

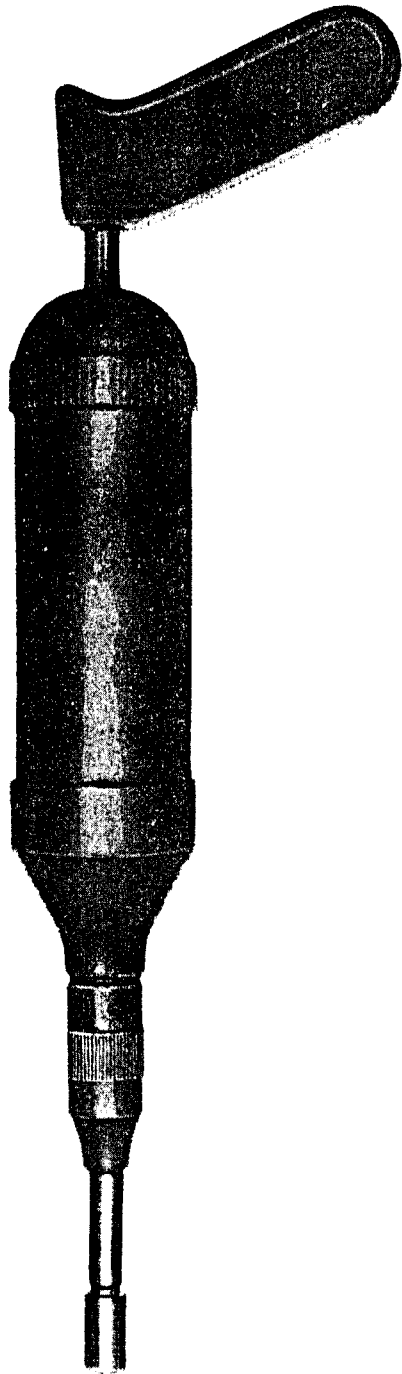

24037-1/6

228776

