

MACHINE PARTS CHART
for
SINGER*

16U288

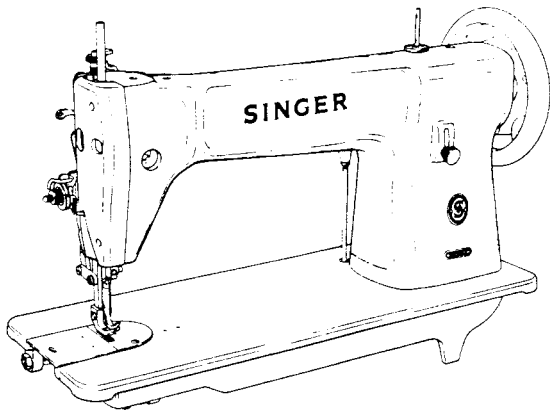

SINGER*

16U288

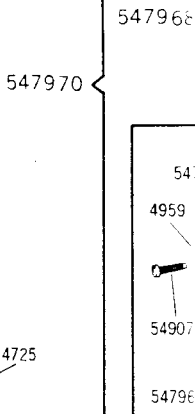
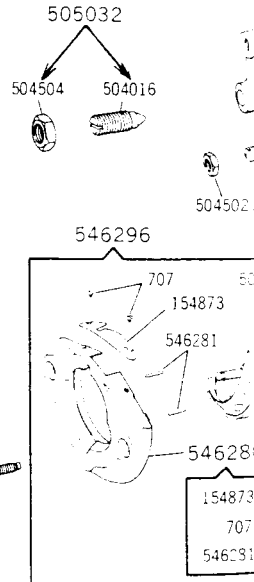
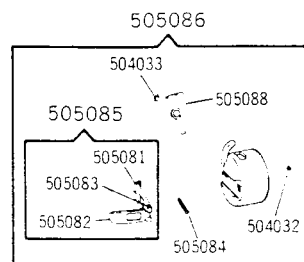
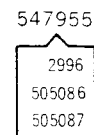
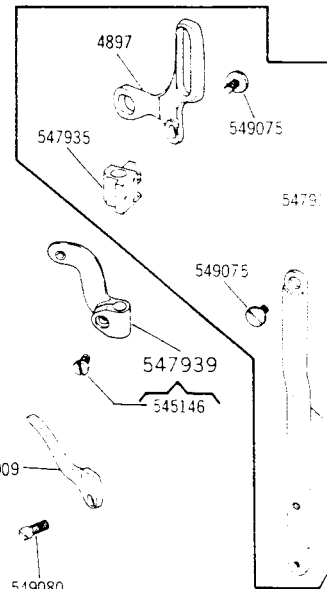
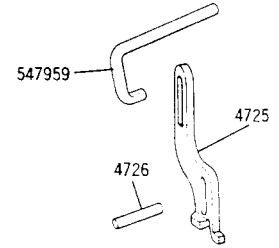
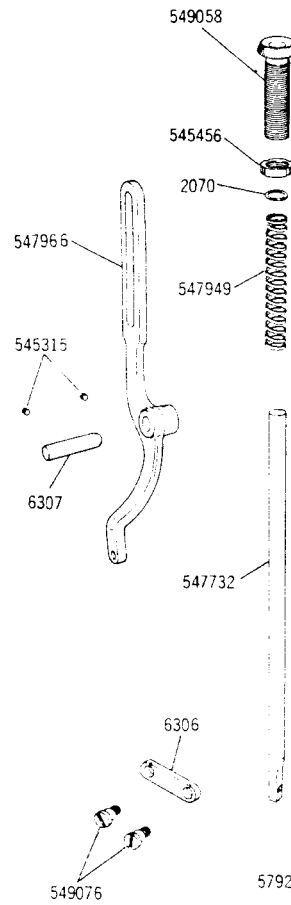
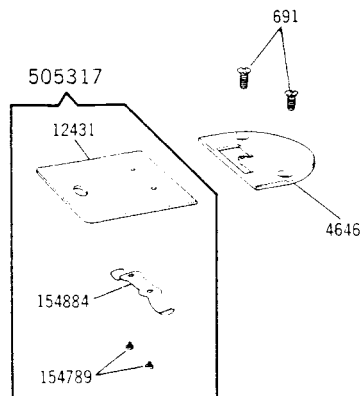
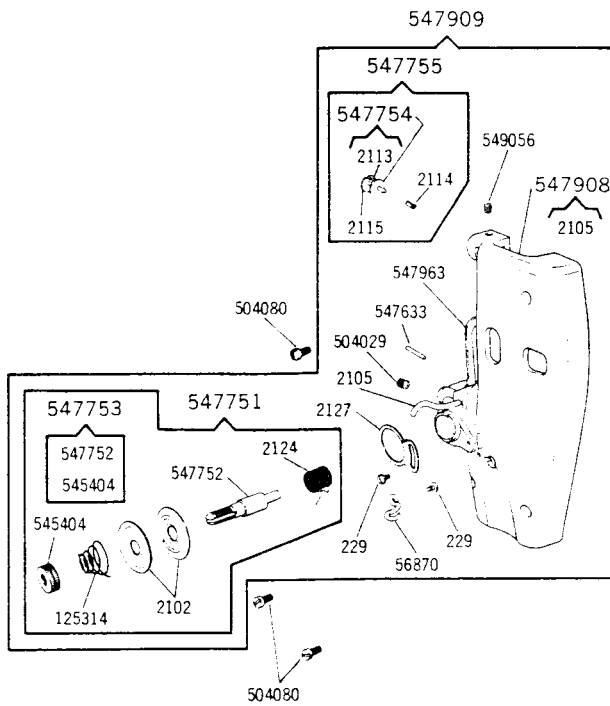

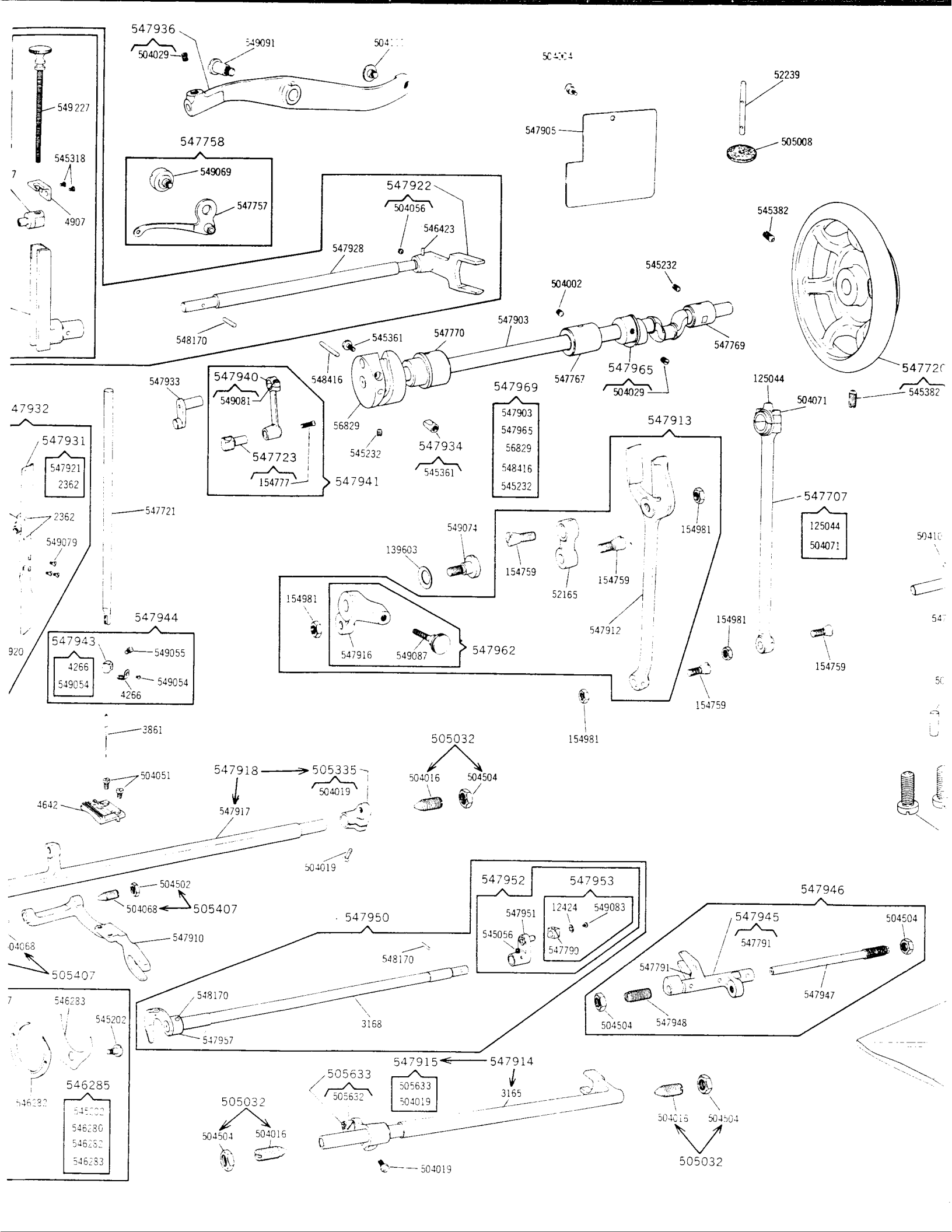

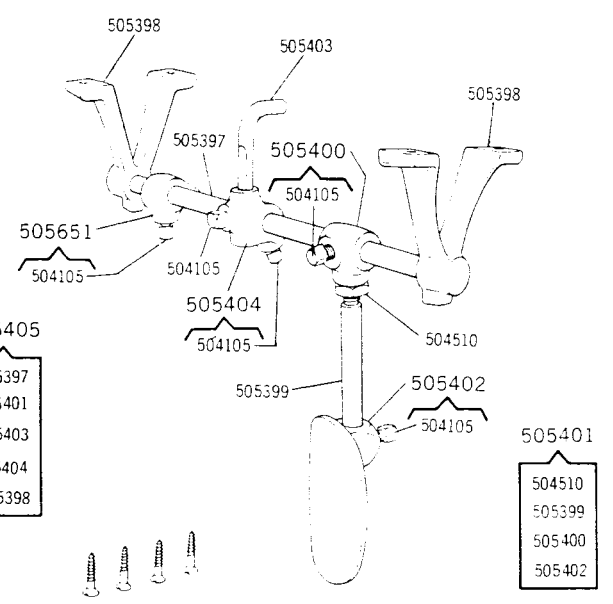
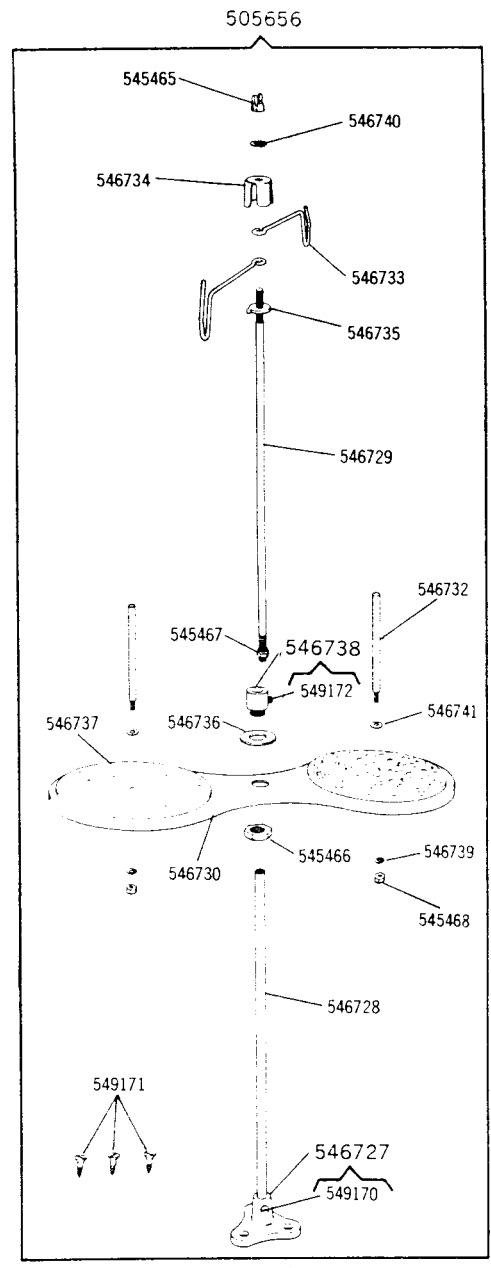
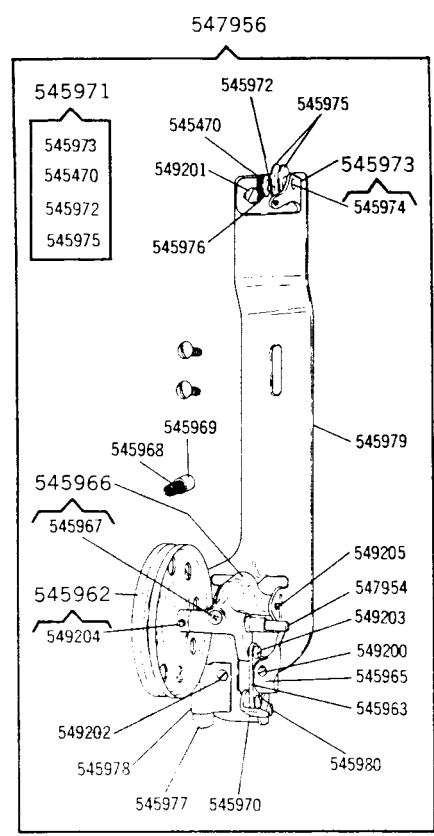
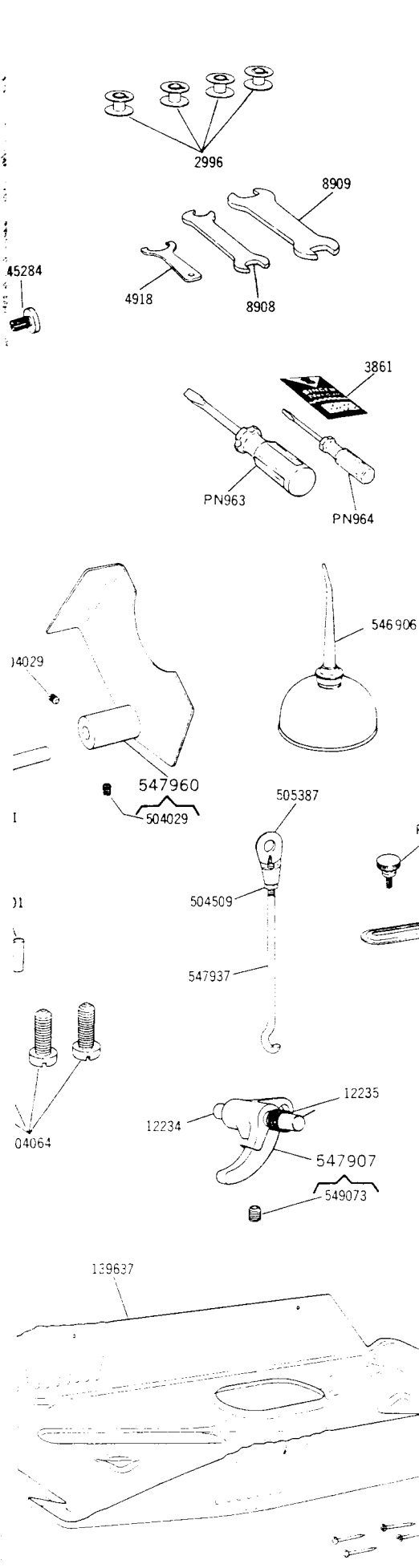

NUMERICAL LIST OF PARTS FOR MACHINE 16U288

PART NO.	DESCRIPTION	PART NO.	DESCRIPTION	PART NO.	DESCRIPTION
229 (809)	Face Plate Thread Guard Screw	154884	Shuttle Race Slide Spring	505086	Shuttle Bobbin Case complete, Nos. 504032 (805), 505084, 505085, 504033 (806) and 505088
229 (809)	Thread Take-up Spring Regulator Plate Adjusting Screw	154981 (819)	Crank Connecting Rod Hinge Screw Nut	505087	Shuttle (body)
691 (850)	Throat Plate Screw (2)	154981 (819)	Feed (lower) Connecting Link Hinge Screw Nut (2)	505088	Shuttle Tension Spring
707 (809)	Shuttle Race Cap Screw (2)	154981 (819)	Feed (lower) Forked Connection Hinge Screw Nut	505317	Shuttle Race Slide complete, Nos. 12431, 154884 and two 154789 (809)
2070	Lifting Presser Bar Spring Washer	504002 (850)	Arm Shaft Bushing (intermediate) Set Screw	505335	Feed (lower) Rock Shaft Crank with 504019 (808)
2102	Tension Disc (2)	504004 (852)	Arm Side Cover Thumb Screw	505387	Lifting Lever Connecting Rod Joint
2105	Tension Thread Guard	504016 (850)	Feed (lower) Lifting Rock Shaft Screw Center (2)	505407	Feed (lower) Bar Screw Center 504068 (803) with 504502 (819)
2113	Thread Retaining Disc Steady Pin	504016 (850)	Feed (lower) Rock Shaft Screw Center (2)	505632	Feed (lower) Lifting Rock Shaft Crank Block
2114	Thread Retaining Spring	504019 (808)	Feed (lower) Lifting Rock Shaft Crank Clamping Screw	505633	Feed (lower) Lifting Rock Shaft Crank Block Stud with 505632
2115	Thread Retaining Stud	504019 (808)	Feed (lower) Rock Shaft Crank Clamping Screw	545056 (833)	Oscillating Shaft Crank Set Screw
2124	Thread Take-up Spring	504029 (833)	Belt Safety Guard Set Screw (2)	545146 (809)	Lifting Presser Bar Bracket Clamping Screw
2127	Thread Take-up Spring Regulator Plate	504029 (833)	Feed (lower and upper) Cam Set Screw	545202 (850)	Shuttle Race Back Spring Thumb Screw
2362	Feed (upper) Bar Hinge Bracket Rivet (2)	504029 (833)	Lifting Lever Hook Set Screw	545232 (833)	Arm Shaft Bushing back Set Screw
2996	Shuttle Bobbin	504029 (833)	Tension Screw Stud Set Screw	545232 (833)	Thread Take-up Cam Set Screw
3165	Feed (lower) Lifting Rock Shaft	504032 (805)	Shuttle Bobbin Case Latch Stop Screw	545284 (802)	Arm Shaft Screw
3168	Oscillating Shaft	504032 (805)	Shuttle Tension Regulating Screw	545314 (810)	Lifting Presser Foot Screw
4266	Needle Clamp Thread Guide	504051 (850)	Feed Dog Screw (2)	545314 (810)	Feeding Foot Screw
4642	Feed Dog 15 teeth, 16 teeth to the inch	504056 (833)	Feed (upper) Forked Connection Set Screw	545315 (803)	Feed (upper) Lever Hinge Pin Set Screw (2)
4646	Throat Plate (large needle hole, for 4642)	504064 (805)	Arm Screw (4)	545318 (810)	Feed (upper) Regulator Thumb Screw Stop Bracket Screw (2)
4725	Lifting Presser Bar Lifting Bracket	504068 (803)	Feed (lower) Bar Screw Center (2)	545361 (803)	Guide Bar Driving Crank Wedge Screw
4726	Lifting Presser Bar Lifting Bracket Guide Pin	504071 (833)	Crank Connecting Rod Cap Screw (2)	545382 (850)	Machine Pulley Set Screw (2)
4897	Lifting Presser Bar Lifting Bell Crank	504080 (851)	Face Plate Screw (3)	545404 (856)	Tension Regulating Thumb Nut
4907	Feed (upper) Regulator Thumb Screw Stop Bracket	504100 (809)	Lifting Lever Connecting Rod Joint Hinge Screw	545456 (851)	Pressure Regulating Thumb Screw Lock Nut
4909	Lifting Presser Bar Lifter	504101 (830)	Belt Safety Guard Shaft Set Screw	546280	Shuttle Race with 154873 and two each 707 (809) and 546281
4959	Feed (upper) Regulator Thumb Screw Stud (brass)	504502 (819)	Feed (lower) Bar Screw Center Nut (2)	546281	Shuttle Race Back Position Pin (2)
5792	Lifting Presser foot	504504 (819)	Feed (lower) Rock Shaft Screw Center Nut (2)	546282	Shuttle Race Back
6306	Feed (upper) Bar Connecting Link	504504 (819)	Oscillating Rock Shaft Hinge Pin Bushing Nut	546283	Shuttle Race Back Spring
6307	Feed (upper) Lever Hinge Pin	504504 (819)	Oscillating Rock Shaft Hinge Pin Nut	546285	Shuttle Race complete, Nos. 545202 (850), 546280, 546282 and 546283
12234	Bell Crank Shaft	504504 (819)	Feed (lower) Lifting Rock Shaft Screw Center Nut (2)	546296	Shuttle Race 546285 and 505087
12235	Bell Crank Spring	504509 (809)	Lifting Lever Connecting Rod Lock Nut	546423	Feed (upper) Forked Connection Pin
12424	Oscillating Shaft Crank Slide Block Cap Screw Washer	505001	Arm Dowel Pin (2)	547633	Tension Releaser Hinge Pin
12431	Shuttle Race Slide	505008	Arm Spool Pin Washer (felt)	547707	Crank Connecting Rod with 125044 and two 504071 (833)
52165	Feed (lower) Connecting Link	505032	Feed (lower) Rock Shaft Screw Center 504016 (850) with 504504 (819)	547720	Machine Pulley with two 545382 (850)
52239	Arm Spool Pin and Thread Eyelet	505032	Feed (lower) Lifting Rock Shaft Screw Center 504016 (850) with 504504 (819)	547721	Needle Bar
56829	Thread Take-up Cam	505081	Shuttle Bobbin Case Latch	547723	Needle Bar Connecting Stud with 154777 (850)
56870	Face Plate Thread Guard	505082	Shuttle Bobbin Case Latch Lever	547732	Lifting Presser Bar
56896	Feeding Foot	505083	Shuttle Bobbin Case Latch Lever Fulcrum Pin	547751	Tension complete, Nos. 125314, 2124, 547753 and two 2102
125044	Crank Connecting Rod Oil Pad felt	505084	Shuttle Bobbin Case Latch Spring	547752	Tension Screw Stud
125314	Tension Spring	505085	Shuttle Bobbin Case Hinge Nos. 505081, 505082 and 505083		
139603	Feed (lower) Regulator Hinge Screw Friction Washer				
154759 (850)	Crank Connecting Rod Hinge Screw				
154759 (850)	Feed (lower) Connecting Link Hinge Screw (2)				
154759 (850)	Feed (lower) Forked Connection Hinge Screw				
154777 (850)	Needle Bar Connecting Stud Set Screw				
154788 (819)	Shuttle Race Screw (2)				
154789 (809)	Shuttle Race Slide Spring Screw (2)				
154873	Shuttle Race Cap				

NUMERICAL LIST OF PARTS FOR MACHINE 16U288

PART NO.	DESCRIPTION	PART NO.	DESCRIPTION
547753	Tension Screw Stud 547752 with 545404 (856)	547941	Needle Bar Connecting Link 547940 with 547723
547754	Thread Retaining Disc with 2113	547943	Needle Clamp with 4266 and 549054 (851)
547755	Thread Retainer Guide complete, Nos. 547754, 2114 and 2115	547944	Needle Clamp 547943 with 549055 (858)
547757	Thread Take-up Lever with Roller and Roller Stud	547945	Oscillating Rock Shaft with 547791
547758	Thread Take-up Lever 547757 with 549069 (851)	547946	Oscillating Rock Shaft 547945 with 547947, 547948 and two 504504 (819)
547767	Arm Shaft Bushing (intermediate)	547947	Oscillating Rock Shaft Hinge Pin
547769	Arm Shaft Bushing (back)	547948	Oscillating Rock Shaft Hinge Pin Bushing
547770	Arm Shaft Bushing (front)	547949	Lifting Presser Bar Spring
547790	Oscillating Shaft Crank Slide Block	547950	Oscillating Shaft 3168 with 547952, 547957 and two 548170
547791	Oscillating Rock Shaft Oil Pad (felt)	547951	Oscillating Shaft Crank
547903	Arm Shaft	547952	Oscillating Shaft Crank complete, Nos. 545056 (833), 547951 and 547953
547905	Arm Side Cover	547953	Oscillating Shaft Crank Slide Block complete, Nos. 549083 (809), 12424 and 547790
547907	Bell Crank with 549073 (810)	547955	Shuttle 1-11/16 in. diam. Nos. 2996, 505086 and 505087
547908	Face Plate with 2105	547957	Shuttle Driver
547909	Face Plate complete, Nos. 2127, 547633, 547963, 56870, 504029 (833), 547751, 547755, 547908, 549056 (833) and two 229 (809)	547959	Lifting Lever Hook
547910	Feed (lower) Bar	547960	Belt Safety Guard with two 504029 (833)
547912	Feed (lower) Forked Connection	547961	Belt Safety Guard Shaft
547913	Feed (lower) Forked Connection complete, Nos. 547912, 52165, 547962 and two each 154759 (850) and 154981 (819)	547962	Feed (lower) Regulator 547916 with 549087 (851)
547914	Feed (lower) Lifting Rock Shaft complete, Nos. 3165 and 547915	547963	Tension Releaser
547915	Feed (lower) Lifting Rock Shaft Crank with 505633 and 504019 (808)	547965	Feed (lower and upper) Cam with 504029 (833)
547916	Feed (lower) Regulator	547966	Feed (upper) Lever
547917	Feed (lower) Rock Shaft	547967	Feed (upper) Regulator
547918	Feed (lower) Rock Shaft complete, Nos. 547917 and 505335	547968	Feed (upper) Regulator complete, Nos. 4907, 4959, 547967, 547927, 549227 (851), 549078 (850) and two 545318 (810)
547920	Feed (upper) Bar	547969	Arm Shaft 547903 with 547965, 56829, 548416 and 545232 (833)
547921	Feed (upper) Bar Hinge Bracket	547970	Feed (upper) Shaft 547928 with 547922, 547968, 548170 and 546423
547922	Feed (upper) Forked Connection with 504056 (833)	548170	Feed (upper) Regulator Pin
547927	Feed (upper) Regulator Slide Block	548170	Oscillating Shaft Crank Pin
547928	Feed (upper) Shaft	548170	Shuttle Driver Pin
547931	Guide Bar with 547921 and two 2362	548416	Thread Take-up Cam Pin
547932	Guide Bar complete, Nos. 4897, 547920, 547931, 547935, two 549075 (809) and three 549079 (803)	549054 (851)	Needle Clamp Thread Guide Screw
547933	Guide Bar Driving Crank	549055 (858)	Needle Clamp Screw
547934	Guide Bar Driving Crank Wedge with 545361 (803)	549056 (833)	Thread Retaining Stud Set Screw
547935	Guide Bar Lifting Bracket	549058 (851)	Pressure Regulating Thumb Screw
547936	Lifting Lever with 504029 (833)	549069 (851)	Thread Take-up Lever Hinge Screw
547937	Lifting Lever Connecting Rod	549073 (810)	Bell Crank Set Screw
547939	Lifting Presser Bar Bracket with 545146 (809)	549074 (803)	Feed (lower) Regulator Hinge Screw
547940	Needle Bar Connecting Link with 549081 (803)	549075 (809)	Feed (upper) Bar Cap Screw
		549075 (809)	Lifting Presser Bar Lifting Bell Crank Hinge Cap Screw

PART NO.	DESCRIPTION
549076 (806)	Feed (upper) Bar Connecting Link Hinge Screw (2)
549078 (850)	Feed (upper) Regulator Thumb Screw Lock Screw
549079 (803)	Guide Bar Lifting Bracket Screw (3)
549080 (803)	Lifting Presser Bar Lifter Screw
549081 (803)	Needle Bar Connecting Link Adjusting Screw
549083 (809)	Oscillating Shaft Crank Slide Block Cap Screw
549087 (851)	Feed (lower) Regulator Thumb Screw
549091 (850)	Lifting Lever Hinge Screw
549227 (851)	Feed (upper) Regulator Thumb Screw

ACCESSORIES

PN966	Cloth Guide
PN967 (852)	Cloth Guide Screw
139637	Drip Pan with Wire Nail (4)
545926	Machine Hinge Connection (2)
20022	Machine Rest (felt) (4) with Wire Nail (4)
41400	Machine Rest Pin (wood) 3-1/8 in. long
3861(16x63)	Needle (6)
546906	Oiler (filled with Singer Type "B" Oil)
PN963	Screw Driver (large)
PN964	Screw Driver (small)
2996	Shuttle Bobbin (4)
8908	Wrench (for 504502)
8909	Wrench (for 154981 and 504504)
4918	Wrench (for 545456)

KNEE LIFTER PARTS

505397	Rock Shaft
505405	Rock Shaft complete, Nos. 505397, 505401, 505403, 505404 and two 505398 and four Wood Screws 1/2 in. No. 9
505398	Rock Shaft Hanger (2)
505399	Rock Shaft Knee Arm
505401	Rock Shaft Knee Arm complete, Nos. 504510 (809), 505399, 505400 and 505402
504510 (809)	Rock Shaft Knee Arm Clamping Nut
505400	Rock Shaft Knee Arm Hub with 504105 (809)
504105 (809)	Rock Shaft Knee Arm Hub Set Screw
505402	Rock Shaft Knee Plate with 504105 (809)

NUMERICAL LIST OF PARTS FOR MACHINE 16U288

PART NO.	DESCRIPTION
504105 (809)	Rock Shaft Knee Plate Set Screw
505403	Rock Shaft Lifting Arm
505404	Rock Shaft Lifting Arm Hub with two 504105 (809)
504105 (809)	Rock Shaft Lifting Arm Hub Set Screw
504105 (809)	Rock Shaft Lifting Arm Set Screw
505651	Rock Shaft Stop Dog with 504105 (809)
504105 (809)	Rock Shaft Stop Dog Set Screw
	Wood Screw 1" No. 9 (4)

BOBBIN WINDER

547956	Universal Bobbin Winder complete, Nos. 545962, 545963, 545965, 545966, 545968, 545969, 545970, 545971, 545976, 545977, 545978, 545979, 547954, 549200 (819), 549201 (819), 549202 (819), 549203 (819), 549205 and two 545980 with two 5.5 x 19 Wood Screws
545979	Bobbin Winder and Tension Bracket Base
545977	Bobbin Winder Brake
545978	Bobbin Winder Brake Clamp
549202 (819)	Bobbin Winder Brake Clamp Screw
545966	Bobbin Winder Frame with 545967
549205	Bobbin Winder Frame Hinge Pin
545967	Bobbin Winder Frame Oil Cup
545968	Bobbin Winder Frame Spring
545969	Bobbin Winder Frame Spring Plunger
545962	Bobbin Winder Pulley with 549204 (819)
549204 (819)	Bobbin Winder Pulley Set Screw
547954	Bobbin Winder Spindle
545965	Bobbin Winder Stop Latch
549200 (819)	Bobbin Winder Stop Latch Screw
545970	Bobbin Winder Stop Latch Thumb Lever
545980	Bobbin Winder Stop Latch Thumb Lever Hinge Stud (2)
545963	Bobbin Winder Stop Latch Trip Lever
549203 (819)	Bobbin Winder Stop Latch Trip Lever Hinge Screw
545973	Bobbin Winder Tension Bracket with 545974
545971	Bobbin Winder Tension complete, Nos. 545470 (819), 545972, 545973 and two 545975
549201 (819)	Bobbin Winder Tension Bracket Screw
545976	Bobbin Winder Tension Bracket Screw Washer
545975	Bobbin Winder Tension Disc (2)
545972	Bobbin Winder Tension Spring
545974	Bobbin Winder Tension Stud

PART NO.	DESCRIPTION
545470 (819)	Bobbin Winder Tension Stud Thumb Nut
	Wood Screw 5.5 x 19 (2)

THREAD UNWINDER

505656	Thread Unwinder (for two spools) complete, Nos. 545465 (856), 545466 (856), 545467 (856), 546727, 546728, 546729, 546730, 546734, 546735, 546736, 546738, 546740, three 549171 and two each 545468 (856), 546732, 546733, 546737, 546739 and 546741
546732	Thread Unwinder Spool Pin (2)
545468 (856)	Thread Unwinder Spool Pin Nut (2)
546739	Thread Unwinder Spool Pin Spring Washer (2)
546741	Thread Unwinder Spool Pin Washer (2)
546738	Thread Unwinder Spool Rest Bushing with 549172 (850)
545466 (856)	Thread Unwinder Spool Rest Bushing Nut
546736	Thread Unwinder Spool Rest Bushing Nut Washer
549172 (850)	Thread Unwinder Spool Rest Bushing Set Screw
546737	Thread Unwinder Spool Rest Felt (2)
546730	Thread Unwinder Spool Rest (for two spools)
546728	Thread Unwinder Spool Rest Rod lower
549170 (828)	Thread Unwinder Spool Rest Rod lower Set Screw
546729	Thread Unwinder Spool Rest Rod upper
545467 (856)	Thread Unwinder Spool Rest Rod upper Nut
546727	Thread Unwinder Spool Stand with 549170 (828)
546733	Thread Unwinder Thread Guide (2)
545465 (856)	Thread Unwinder Thread Guide Lock Nut
546740	Thread Unwinder Thread Guide Lock Nut Spring Washer
546734	Thread Unwinder Thread Guide Position Cup
546735	Thread Unwinder Thread Guide Rod Washer
549171	Wood Screw No. 10 x 1 inch (3)