

Form 18627
September, 1932
PRINTED IN U. S. A.

LIST OF PARTS



SINGER** MACHINES

Nos. 147-60 and 147-61

THE SINGER MANUFACTURING COMPANY

**A Trade Mark of THE SINGER MANUFACTURING COMPANY

INSTRUCTIONS FOR OILING

To ensure easy running and prevent unnecessary wear of the parts which are in movable contact, the machine requires oiling and when in continuous use, "TYPE B" or "TYPE D" OIL, sold by Singer Sewing Machine Company, should be applied at least twice each day to all oil holes marked "OIL".

"TYPE D" OIL should be used when an oil is desired which will produce a minimum of stain on fabrics, even after a long period of storage.

The letter "o", marked on oil pipe couplings must always be at the top. This is to insure that the oil spoon, attached to the inner end of each coupling, is open side up to receive the oil.

INDEX

	PAGE
ACCESSORIES.....	37
BELT GUARD.....	37
BENCH STAND.....	37
FITTINGS FOR 147-60 MACHINE (LAP SEAM FELLER No. 120906).....	35
FITTINGS FOR 147-61 MACHINE (LAP SEAM FELLER No. 120848).....	36
FOOT LIFTER PARTS.....	38
KNEE LIFTER PARTS.....	38
LAP SEAM FELLERS.....	37
MACHINE NO. 147-60.....	7
" " 147-61.....	21
" BASE.....	39
NUMERICAL LIST OF PARTS.....	41
THREAD UNWINDER.....	39

INSTRUCTIONS FOR ORDERING

In ordering from this list, use **ONLY** the part NUMBER in the **FIRST** column.

The number stamped on a Sewing Machine Part is in every case the number of the single part only.

Every combination of parts sent out as such has its specific number, which, although not stamped on the parts, must be used when ordering the combination.

Each number always indicates the **SAME PART** in whatever list it appears, or for whatever machine.

The letters after some of the numbers indicate the style of finish only, as follows:

- A—Hardened, Polished, Nickel Plated and Buffed
- B—Polished, Nickel Plated and Buffed
- C—Hardened Only
- D—Polished Only
- E—Soft, Not Polished
- F—Hardened and Polished
- H—Blued
- J—Nickel Plated Only
- K—Hardened and Nickel Plated
- L—Brass Plated
- M—Oxidized
- N—Japanned, Dull
- P—Japanned, Bright
- R—Merlized
- T—Copper Plated
- T. A.—Hardened, Polished, Copper and Nickel Plated and Buffed
- T. B.—Copper and Nickel Plated and Polished
- T. J.—Copper and Nickel Plated Only
- T. K.—Hardened, Copper and Nickel Plated
- T. M.—Copper Plated and Oxidized
- T. L.—Copper and Brass Plated
- U—Zinc Plated
- V—Silver Plated
- W—Polished and Nickel Plated
- Z—Chromium Plated
- Z. B.—Polished, Nickel Plated, Buffed and Chromium Plated
- Z. J.—Nickel and Chromium Plated

These letters **MUST BE USED** when they appear in the list; and **AFTER** the number **as** in the list.

In this series:

- 1 to 1500 and 50001 to 51500 are Screw Numbers
- 1501 to 1800 and 51501 to 51800 are Nut Numbers
- 1801 to 2000 and 51801 to 52000 are Roller Numbers
- 2001 to 50000 and 52001 and upward are numbers of Machine Parts

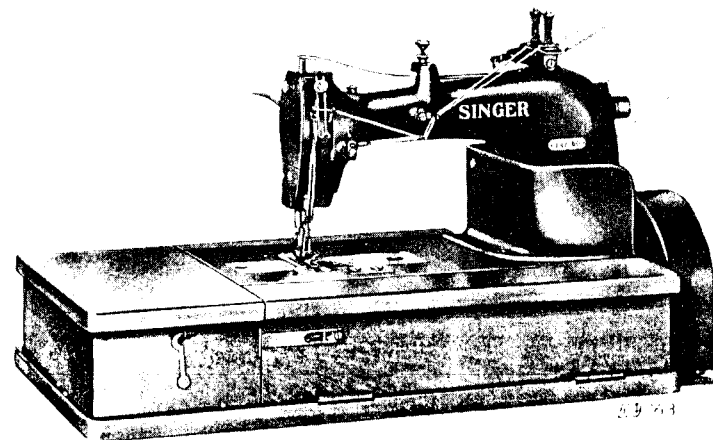
The figures in the second column refer only to the plates, illustrating the parts, and are **NOT TO BE USED** in ordering.

Parts marked with an asterisk (*) are furnished only when repairs are made at factory.

When ordering parts which differ as to **Gauge** (the distance between seams) the Gauge, as well as the **Number must be given** on order.

LIST OF PARTS COMPLETE

FOR



MACHINE No. 147-60

FOR LAP SEAMING SHIRT SLEEVES OF LIGHT WEIGHT MATERIALS AND WORK OF A SIMILAR NATURE. TWO NEEDLES, TWO LOOPERS. GAUGES $\frac{3}{8}$ IN. TO $\frac{1}{2}$ IN. SHORT NEEDLE BAR AND LOOPER STROKE.

THE LOOPERS ARE ARRANGED SO THAT THEY MAY BE THROWN OUT OF POSITION FOR CONVENIENCE IN THREADING. AN IMPROVED OILING SYSTEM AUTOMATICALLY OILS ALL OF THE PRINCIPAL BEARINGS OF THE MACHINE. BALANCE WHEEL NO. 64259. DIAMETER OF BELT GROOVE 2 INCHES. SPEED 4300.

NO.	PLATE	NAME
*68427	—	Arm, upper and lower (solid) with 948J, 68483 and four 131022.....
68428	9917	Arm Bottom Cover.....
68429	9917	" " " Gasket (cork).....
1057 _E	20503	" " " Screw.....
68350	9922	" Oil Cup for oiling Arm Rock Shaft Front Bearing.....
68430	9922	Arm Oil Cup for filling oil reservoir....
54648	9922	" " " Oil Pad (braided cotton) for 68350.....
68431	9916	Arm Rock Shaft.....
68432	—	" " " 68431 with 1235 _F and 68439.....

NO.	PLATE	NAME
1309c	20504	Arm Rock Shaft Adjusting Screw.....
131056	20504	“ “ “ “ “ Washer
68433	9916	“ “ “ Bushing (back).....
68434	——	“ “ “ “ “ 68433 with 52045.....
68435	9916	Arm Rock Shaft Bushing (back) Cap
131095	9916	“ “ “ “ “ “ Washer (fibre).....
52045	9922	Arm Rock Shaft Bushing (back) Oil Pad (wick).....
446c	20503	Arm Rock Shaft Bushing (back) Set Screw.....
68436	9916	Arm Rock Shaft Bushing (intermediate)
68437	——	“ “ “ “ “ “ 68436 with 52045.....
52045	9922	Arm Rock Shaft Bushing (intermediate) Oil Pad (wick).....
423c	20503	Arm Rock Shaft Bushing (intermediate) Set Screw.....
131072	9916	Arm Rock Shaft Crank back (ball bear- ing, solid) with two 50083c.....
50083c	20503	Arm Rock Shaft Crank (back) Set Screw.....
68439	9916	Arm Rock Shaft Crank (front) with 443c and 853c.....
2117	20504	Arm Rock Shaft Crank (front) Pin.....
443c	20503	“ “ “ “ “ Set Screw
54105	9916	“ “ “ Flanged Bushing (front).....
52045	9922	Arm Rock Shaft Flanged Bushing (front) Oil Pad (wick).....
453c	20503	Arm Rock Shaft Flanged Bushing (front) Set Screw.....
1235f	20503	Arm Rock Shaft Oil Plug Screw.....
42365	9922	“ “ “ “ Pad (braided cot- ton) for oiling Back Bearing.....
54969	9922	Arm Rock Shaft Oil Pad (braided cot- ton) for oiling Intermediate Bearing.
68446	20508	Arm Rotary Shaft.....

NOTE: When No. 68440 is required for repairs, the
Looper Driving Shaft and Feed Lifting Eccentric
must be returned to the factory to be
adjusted to the new part.

68441	——	Arm Rotary Shaft 68440 with 640E, 54450, 68459, 68470, 68482 and 131016.....
-------	----	--

NO.	PLATE	NAME
68442	20501	Arm Rotary Shaft Bushing (front).....
761E	20503	“ “ “ “ “ Set Screw.....
68443	9917	Arm Rotary Shaft Bushing (intermediate)
68444	——	“ “ “ “ “ “ 68443 with 41128.....
41128	9922	Arm Rotary Shaft Bushing (intermediate) Oil Pad (braided cotton).....
422c	20503	Arm Rotary Shaft Bushing (intermediate) Set Screw (long).....
50084c	20503	Arm Rotary Shaft Bushing (intermediate) Set Screw (short).....
54450	20501	Arm Rotary Shaft Collar with two 1258c.....
1258c	9925	Arm Rotary Shaft Collar Set Screw....
68445	9917	“ “ “ Flanged Bushing
68446	——	“ “ “ “ “ “ 68445 with 42367.....
42367	9922	Arm Rotary Shaft Flanged Bushing Oil Pad (braided cotton).....
159E	20503	Arm Rotary Shaft Flanged Bushing Screw.....
42367	9922	Arm Rotary Shaft Front Bearing Oil Pad lower (braided cotton).....
54218	9922	Arm Rotary Shaft Front Bearing Oil Pad upper (braided cotton).....
57974	9922	Arm Rotary Shaft Oil Pad (braided cotton) for oiling Back Bearing.....
56006	9922	Arm Rotary Shaft Oil Pad (braided cotton) for oiling Intermediate Bear- ing.....
144D	20503	Arm Rotary Shaft Screw.....
68447	9917	“ Side Cover.....
68448	9917	“ “ “ Gasket (cork).....
1057J	20503	“ “ “ Screw.....
64259	20508	Balance Wheel, 2 in. pulley, with two 51283c.....
51283c	20503	Balance Wheel Set Screw.....
68449	20508	Cloth Plate.....
68368	9918	“ “ Slide (left).....
131050	9918	“ “ “ “ Spring.....
725J	20503	“ “ “ “ “ Screw....
131051	——	Cloth Plate Slide (left) complete, Nos. 68368, 131050 and two 725J.....
54055	20507	Cloth Plate Slide (right) for 54056.....
54057	20507	“ “ “ “ “ 54058.....
68166	20507	“ “ “ “ “ 68167.....

NO.	PLATE	NAME
131206	20507	Cloth Plate Slide (right) for 131207....
38419	20504	" " " " Spring.....
725J	20503	" " " " " Screw..
54056	—	Cloth Plate Slide (right) complete for 68450, Nos. 38419, 54055 and two 725J.....
54058	—	Cloth Plate Slide (right) complete for 131114, Nos. 38419, 54057 and two 725J.....
68167	—	Cloth Plate Slide (right) complete for 131031, Nos. 38419, 68166 and two 725J.....
131207	—	Cloth Plate Slide (right) complete for 131208, Nos. 38419, 131206 and two 725J.....
68450	—	Cloth Plate complete, to be used with Throat Plates Nos. 131033 and 131172 when $\frac{3}{2}$ in. to $\frac{5}{2}$ in. gauges are required, and Throat Plates Nos. 131017 and 131173 for $\frac{3}{8}$ in. to $\frac{1}{4}$ in. gauges, Nos. 54056, 68449 and 131051
131031	—	Cloth Plate complete, to be used with Throat Plates Nos. 131017 and 131173 when $\frac{9}{32}$ in. and $\frac{5}{16}$ in. gauges are required, Nos. 68167, 68449 and 131051.....
131114	—	Cloth Plate complete, to be used with Throat Plates Nos. 131094 and 131149 when $\frac{1}{2}$ in. and $\frac{3}{8}$ in. gauges are required, Nos. 54058, 68449 and 131051.....
131208	—	Cloth Plate complete, to be used with Throat Plates Nos. 131163 and 131166 when $\frac{1}{2}$ in. to $\frac{1}{2}$ in. gauges are required, Nos. 68449, 131051 and 131207.....
1011F	20503	Cloth Plate Screw (left).....
50396F	20503	" " " (right).....
131130	20508	" " Thread Guard.....
389F	20503	" " " " Screw (lower)
50473F	20503	" " " " " (upper)
68452	9916	Crank Connecting Rod (rod only).....
*68453	—	" " " Cap (lower)....
896E	20503	" " " " " Screw
*54018	—	" " " " " (upper)....
1057E	20503	" " " " " Screw

NO.	PLATE	NAME
*68454	—	Crank Connecting Rod End Bearing (lower).....
*68455	—	Crank Connecting Rod End Bearing (upper).....
68456	9916	Crank Connecting Rod Head (lower), Nos. 68453, 68454 and two 896E....
68457	9916	Crank Connecting Rod Head (upper), Nos. 54018, 68455 and two 1057E....
1722E	20503	Crank Connecting Rod Nut (lower)....
1723E	20503	" " " " (upper)....
68458	9916	" " " complete, Nos. 1722E, 1723E, 68452, 68456 and 68457
68459	—	Crank Connecting Rod 68458 with 131072.....
68460	9918	Face Plate (lower half).....
68461	9918	" " " " Gasket (cork)..
330D	20503	" " " " Screw.....
68462	9918	" " (upper half).....
29234	20504	" " " " Position Plate
1053E	20504	" " " " " " Screw.....
286D	20503	Face Plate (upper half) Thumb Screw..
68463	9918	Feed Bar.....
68464	9918	Feed Bar complete, Nos. 50429c, 54648, 68463, 68467 and two 207E.....
131197	9918	Feed Bar Hinge Pin (eccentric).....
59343	9925	" " " " Collar with 735c...
735c	9925	" " " " " Set Screw...
54648	9922	" " Oil Pad (braided cotton)....
134258	9918	" " Slide Block.....
134259	9918	" " " " 134258 with 68495 and 134260.....
68495	9922	Feed Bar Slide Block Oil Pad (wick)...
134260	9922	" " " " " Retainer
68467	9918	" " Wearing Plate.....
207E	20503	" " " " " Screw.....
68468	9918	" " Connecting Rod with 1057E, 68469 131090, 134260 and two 896E.....
68470	—	Feed Connecting Rod 68468 with 68474
*68469	—	" " " Cap.....
896E	20503	" " " " Screw.....
1057E	20503	" " " Clamping Screw
68471	9918	" " " Cover.....
176J	20503	" " " " Screw....
131090	9922	" " " Oil Pad (wick)...
134260	9922	" " " " " Retainer

NO.	PLATE	NAME
131032	20510	Feed Dog, 17 teeth (16 teeth to the inch) for $\frac{3}{32}$ in. to $\frac{5}{32}$ in. gauges, for 131033 and 131172.....
68472	20511	Feed Dog, 16 teeth (16 teeth to the inch) for $\frac{1}{16}$ in. to $\frac{1}{8}$ in. gauges, with row of teeth between the needles, for 131017 and 131173.....
131093	20512	Feed Dog, 16 teeth (16 teeth to the inch) for $\frac{1}{12}$ in. and $\frac{3}{8}$ in. gauges, for 131094 and 131149.....
131160	20513	Feed Dog, 16 teeth (16 teeth to the inch) for $\frac{3}{8}$ in. to $\frac{1}{2}$ in. gauges, for 131163 and 131166.....
157J	20503	Feed Dog Screw, when stationary Needle Guard is used.....
50073J	20503	Feed Dog Screw, when movable Needle Guard is used.....
50429c	20503	Feed Dog Stop Screw.....
*68473	—	“ Eccentric.....
*54455	—	“ “ Body.....
51061c	20503	“ “ “ Set Screw.....
7071	9925	“ “ Clamping Washer.....
217J	20503	“ “ “ “ Screw.....
68474	9918	Feed Eccentric (adjustable) complete, Nos. 217J, 1103c, 7071, 54455, 68473 and two 51061c.....
1103c	20503	Feed Regulating Screw.....
131195	20502	“ Rocking Frame with two 453c....
131196	—	“ “ “ 131195 with 59343, 68464 and 131197.....
57234	20502	Feed Rocking Frame Hinge Pin.....
57235	20501	“ “ “ “ “ Bushing.....
453c	20503	“ “ “ “ “ “ Set Screw.....
453c	20503	Feed Rocking Frame Hinge Pin Set Screw.....
68476	9919	Looper (back) closed eye, for lap seam felling.....
131131	9919	Looper (back) closed eye, for general work.....
NOTE: When ordering Nos. 68476 or 131131, state gauge of machine for which required.		
452c	9919	Looper (back) Set Screw.....
68477	9919	“ (front) closed eye, for lap seam felling.....

NO.	PLATE	NAME
131132	9919	Looper (front) closed eye, for general work.....
NOTE: When ordering Nos. 68477 or 131132, state gauge of machine for which required.		
1120c	9919	Looper (front) Set Screw.....
54027	9919	“ Carrier with two 175E.....
175E	9919	“ “ Adjusting Screw.....
54227	9919	“ “ Connection.....
54228	9919	“ “ “ Shaft.....
128419	9922	“ “ “ “ Oil Pad (braided cotton).....
68478	9919	Looper Carrier Connection Shaft Sleeve (eccentric).....
51263D	9919	Looper Carrier Connection Shaft Sleeve Cap Screw.....
68479	9919	Looper Carrier Driver with 68480 and four 175E.....
*68480	—	Looper Carrier Driver Cap.....
175E	9919	“ “ “ “ Screw.....
68481	20502	“ Driving Shaft and Feed Lifting Eccentric with two 64315.....
NOTE: When No. 68481 is required for repairs, the Arm Rotary Shaft must be returned to the factory to be adjusted to the new part.		
68482	—	Looper Driving Shaft and Feed Lifting Eccentric 68481 with 54027, 54227, 54228 and 68479.....
*68483	—	Looper Driving Shaft and Feed Lifting Eccentric Bracket with 761E.....
948J	20503	Looper Driving Shaft and Feed Lifting Eccentric Bracket Screw.....
68484	20502	Looper Driving Shaft and Feed Lifting Eccentric Bushing.....
131028	9925	Looper Driving Shaft and Feed Lifting Eccentric Bushing Oil Plug.....
761E	20503	Looper Driving Shaft and Feed Lifting Eccentric Bushing Position Screw....
68497	9922	Looper Driving Shaft and Feed Lifting Eccentric Front Bearing Oil Pad (wick).....
64315	9925	Looper Driving Shaft and Feed Lifting Eccentric Oil Hole Plug.....
640E	20503	Looper Driving Shaft and Feed Lifting Eccentric Screw.....
131052	9919	Looper Holder with 452c and 1120c....
51119J	20503	“ “ Screw.....

NO.	PLATE	NAME
68485	20502	Looper Throw-out Handle with two 443c.....
68486	20502	Looper Throw-out Handle Plunger.....
43503	20504	" " " " Spring
443c	20503	" " " " Set Screw...
64319	9923	Needle Bar (hollow).....
131045	-----	Needle Bar complete, for $\frac{3}{8}$ in. to $\frac{1}{2}$ in. gauges, Nos. 64319 and 131044...
68487	9923	Needle Bar Bushing (lower).....
1133E	9923	" " " " Set Screw.
64320	9923	" " " (upper).....
1133E	9923	" " " " Set Screw.
68488	9923	" " Connecting Link and Thread (upper) Controller.....
131017	-----	Needle Bar Connecting Link and Thread (upper) Controller 68488 with 68490 and 68491.....
68489	9923	Needle Bar Connecting Link Hinge Stud (hollow).....
68490	-----	Needle Bar Connecting Link Hinge Stud 68489 with 861c and 130007....
1520J	9923	Needle Bar Connecting Link Hinge Stud Nut.....
130007	9923	Needle Bar Connecting Link Hinge Stud Oil Pad (wick).....
861c	9923	Needle Bar Connecting Link Hinge Stud Oil Plug Screw.....
853c	9923	Needle Bar Connecting Link Hinge Stud Set Screw.....
68491	9923	Needle Bar Connecting Stud with 211F and two 187E.....
187E	9923	Needle Bar Connecting Stud Clamping Screw.....
131044	9923	Needle Clamp with two 1498F, for $\frac{3}{8}$ in. to $\frac{1}{2}$ in. gauges.....
131174	9920	Needle Guard (movable) for $\frac{3}{8}$ in. gauge.....
131121	9920	Needle Guard (movable) for $\frac{1}{2}$ in. to $\frac{1}{2}$ in. gauges.....
68123	9920	Needle Guard (movable) Clamp.....
54067	9920	" " (stationary) for $\frac{3}{8}$ in. to $\frac{5}{16}$ in. gauges.....
54068	9920	Needle Guard (stationary) for $\frac{3}{8}$ in. to $\frac{9}{16}$ in. gauges.....
54069	9920	Needle Guard (stationary) for $\frac{5}{16}$ in. to $\frac{3}{8}$ in. gauges.....

NO.	PLATE	NAME
131175	9920	Needle Guard (stationary) for $\frac{3}{8}$ in. to $\frac{1}{2}$ in. gauges.....
54038	9920	Needle Guard (stationary) Holder.....
176J	20503	" " " " Screw
217C	20503	" " " " Screw.....
1498F	9923	" Set Screw.....
68492	9921	Oil Pipe (back of arm) with 49191 and 68497, for oiling Feed Rocking Frame Hinge Pin Front Bearing.....
68493	9921	Oil Pipe (back of arm) Clamp.....
176E	20503	" " " " " " Screw...
68494	9921	" " " " " " Connection with 49189, 68495 and two 198E, for oiling Feed Rocking Frame Hinge Pin Back Bearing.....
*49189	-----	Oil Pipe (back of arm) Connection Cap
198E	9925	" " " " " " " " Screw.....
68495	9922	Oil Pipe (back of arm) Connection Oil Pad (wick).....
68496	9921	Oil Pipe (back of arm) Coupling.....
1733	9925	" " " " " " " Nut (brass).....
68497	9922	Oil Pipe (back of arm) Oil Pad (wick)..
*49191	-----	" " " " " Sleeve.....
68498	9921	" " (front of arm) with two each 1733, 49191 and 131089, for oiling Looper Driving Shaft and Feed Lifting Eccentric Front Bearing.....
131112	9921	Oil Pipe (front of arm) with 68497 and 131003, for oiling Feed Bar Slide Block.....
68500	9921	Oil Pipe (front of arm) with 1733, 49191, 131084 and 131089, for oiling Arm Rotary Shaft Front Bearing.....
131001	9921	Oil Pipe (front of arm) with 68497 and 131003, for oiling Feed Connecting Rod.....
131002	9921	Oil Pipe (front of arm) Connection with 131019 and two 198E, for oiling Looper Throw-out Device.....
131003	9921	Oil Pipe (front of arm) Connection with 49189 and two 198E, for 131001 and 131112.....
131084	9921	Oil Pipe (front of arm) Connection with 131085 and two 198E, for 68500.....

NO.	PLATE	NAME
*49189	---	Oil Pipe (front of arm) Connection Cap for 131003.....
*131049	---	Oil Pipe (front of arm) Connection Cap for 131002.....
*131085	---	Oil Pipe (front of arm) Connection Cap for 131084.....
198E	9925	Oil Pipe (front of arm) Connection Cap Screw.....
131004	9921	Oil Pipe (front of arm) Coupling (center).....
131004	9921	Oil Pipe (front of arm) Coupling (left)
*131086	---	" " " " " " (right)
131087	9921	" " " " " " " "
		131086 with 131088.....
*131088	---	Oil Pipe (front of arm) Coupling (right) Oil Lead.....
1733	9925	Oil Pipe (front of arm) Coupling Nut (brass).....
131089	9922	Oil Pipe (front of arm) Oil Pad (wick) for 68498 and 68500.....
68497	9922	Oil Pipe (front of arm) Oil Pad (wick) for 131001 and 131112.....
*49191	---	Oil Pipe (front of arm) Sleeve.....
64330	20502	Presser Bar with 25303.....
25303	9923	" " Ball, size 1/4 in.....
131006	9923	" " Bushing (lower).....
1133E	9923	" " " " Set Screw.
38456	9923	" " " (upper).....
1133E	9923	" " " " Set Screw.
54039	9920	" " Guide Bracket with 453c, 610J and 1963.....
640J	20503	Presser Bar Guide Bracket Adjusting Screw.....
11173	9920	Presser Bar Guide Bracket Guide....
447C	9920	" " " " " " Set Screw.....
1963	9920	Presser Bar Guide Bracket Roller and Stud.....
453C	20503	Presser Bar Guide Bracket Set Screw..
57257	20504	" " Lifter.....
50592C	20504	" " " Hinge Screw.....
1250C	20504	" " " Stop Screw.....
131007	9920	" " Lifting Bracket with 462c..
131008	9920	" " " " Connection
61075	9920	" " " " " "
		Connecting Pin.....

NO.	PLATE	NAME
462C	9920	Presser Bar Lifting Bracket Connection Connecting Pin Set Screw.....
131009	20502	Presser Bar Lifting Lever.....
68184	20502	" " " " Extension (back).....
161J	20504	Presser Bar Lifting Lever Extension (back) Screw.....
131010	20502	Presser Bar Lifting Lever Extension (front).....
176J	20503	Presser Bar Lifting Lever Extension (front) Screw.....
802D	20504	Presser Bar Lifting Lever Hinge Screw.
38467	20502	" " Spring (flat).....
38468	9925	" " " Stud.....
26276	20511	" Foot Hinge Pin.....
120352	---	" " Plate.....
46087	---	" " Shank.....
120353	20510	Presser Foot (hinged) complete, for 3/8 in. to 1/2 in. gauges, for lap seam felling, Nos. 26276, 46087 and 120352
26276	20511	Presser Foot Hinge Pin.....
131158	---	" " Plate.....
54120	---	" " Shank.....
131159	20511	Presser Foot (hinged) complete, for 5/8 in. to 3/4 in. gauges, for lap seam felling, Nos. 26276, 54120 and 131158
NOTE: Presser Foot No. 131159 is regularly furnished with this machine unless another Presser Foot is specified on order.		
26276	20511	Presser Foot Hinge Pin.....
131161	---	" " Plate.....
54120	---	" " Shank.....
131162	20513	Presser Foot (hinged) complete, for 3/8 in. to 1/2 in. gauges, for lap seam felling, Nos. 26276, 54120 and 131161
26276	20511	Presser Foot Hinge Pin.....
131164	---	" " Plate.....
46087	---	" " Shank.....
131165	20510	Presser Foot (hinged) complete, for 3/2 in. to 1/2 in. gauges, for plain stitching, Nos. 26276, 46087 and 131164..
190J	9925	Presser Foot Screw.....
574W	9925	Pressure Regulating Thumb Screw....
1539W	9925	" " " " Lock Nut.....
131025	9925	Slack Thread Controller.....
54242	9925	" " " " Clamp.....

NO.	PLATE	NAME
190J	9925	Slack Thread Controller Clamp Screw..
64337	9925	" " Regulator.....
54042	9925	" " " Holder with 175E and two 50150c.....
175E	9919	Slack Thread Regulator Holder Clamp- ing Screw.....
131042	9925	Slack Thread Regulator Holder Shaft
24292	9925	" " " " "
		Collar with 1019c.....
1019c	9925	Slack Thread Regulator Holder Shaft Collar Set Screw.....
54044	9920	Slack Thread Regulator Holder Shaft Crank (forked) with 1253c.....
1253c	9920	Slack Thread Regulator Holder Shaft Crank Set Screw.....
50150c	9925	Slack Thread Regulator Set Screw.....
131012	20502	Tension (under thread) Bracket.....
691F	9924	" " " " Screw..
2102	9924	" " " Disc
51570c	9924	" " " Regulating Thumb Nut.....
50326c	9924	Tension (under thread) Screw Stud.....
59539	-----	" " " " " 50326c with 51570c.....
59534	9924	Tension (under thread) Spring.....
59537	9924	" " " " Bushing (large).....
59538	9924	Tension (under thread) Spring Bushing (small).....
17547	9924	Tension (under thread) Thread Guide..
54070	20506	" (upper thread) Bracket.....
376J	9924	" " " " Screw
2102	9924	" " " Disc.....
51570c	9924	" " " Regulating Thumb Nut.....
32572	9924	Tension (upper thread) Releasing Disc
54988	9924	" " " " Pin
54071	20506	" " " " Shaft
54047	9924	" " " " " Crank with 624c.....
54048	9924	Tension (upper thread) Releasing Shaft Crank Link.....
624c	9924	Tension (upper thread) Releasing Shaft Crank Set Screw.....
68261	9924	Tension (upper thread) Releasing Shaft Spring.....

NO.	PLATE	NAME
131011	9924	Tension (upper thread) Releasing Shaft Spring Position Plate.....
316c	9924	Tension (upper thread) Releasing Shaft Stop Screw.....
1547J	9924	Tension (upper thread) Releasing Shaft Stop Screw Nut.....
50326c	9924	Tension (upper thread) Screw Stud.....
59539	-----	" " " " " 50326c with 51570c.....
59535	9924	Tension (upper thread) Spring.....
59537	9924	" " " " Bushing (large).....
59538	9924	Tension (upper thread) Spring Bushing (small).....
57076	9924	Tension (upper thread) Thread Guide (double).....
53225	9924	Thread (under) Eyelet (back).....
190J	9925	" " " " Screw...
131013	9925	" " " (front).....
131014	9925	" " Take-up with two 465c 465c 9925 " " Set Screw.....
54435	9925	" " " Staple with 590E and 38481.....
131157	20506	Thread (under) Take-up Staple Bracket with 460c
965D	20501	Thread (under) Take-up Staple Bracket Screw.....
46041	20501	Thread (under) Take-up Staple Spring
190J	9925	" " " " " Screw.....
38481	9925	Thread (under) Take-up Staple Thread Guard.....
590E	9925	Thread (under) Take-up Staple Thread Guard Screw.....
131096	20501	Thread (under) Take-up Stripper.....
190J	9925	" " " " " Screw
131016	20501	Thread (under) Take-up Thread Guard (brass).....
64356	20501	Thread (under) Take-up Thread Guard Steady Pin.....
460c	20501	Thread (under) Take-up Thread Guard Steady Pin Set Screw.....
46009	20501	Thread (upper) Eyelet.....
190J	9925	" " " " Screw.....
54094	20501	" " Take-up.....
54095	20501	" " " Plate.....
68164	20501	" " " " Spring

NO.	PLATE	NAME
1449J	20501	Thread (upper) Take-up Plate Spring Screw.....
54096	----	Thread (upper) Take-up complete, Nos. 1449J, 54094, 54095 and 68164.....
211F	9923	Thread (upper) Take-up Set Screw.....
131033	20510	Throat Plate, for $\frac{3}{8}$ in. to $\frac{5}{8}$ in. gauges, for 131032, for lap seam felling.....
131017	20511	Throat Plate, for $\frac{3}{8}$ in. to $\frac{5}{8}$ in. gauges, for 68472, for lap seam felling.....
131149	20512	Throat Plate, for $\frac{1}{2}$ in. and $\frac{3}{8}$ in. gauges, for 131093, for lap seam felling.....
131163	20513	Throat Plate, for $\frac{3}{8}$ in. to $\frac{1}{2}$ in. gauges, for 131160, for lap seam felling.....
131172	20510	Throat Plate, for $\frac{3}{8}$ in. to $\frac{5}{8}$ in. gauges, for 131032, for plain stitching.....
131173	20511	Throat Plate, for $\frac{3}{8}$ in. to $\frac{5}{8}$ in. gauges, for 68472, for plain stitching.....
131094	20512	Throat Plate, for $\frac{1}{2}$ in. and $\frac{3}{8}$ in. gauges, for 131093, for plain stitching.....
131166	20513	Throat Plate, for $\frac{3}{8}$ in. to $\frac{1}{2}$ in. gauges, for 131160, for plain stitching.....
NOTE: When ordering Throat Plates, state gauge required.		
742F	20504	Throat Plate Screw.....

SINGER Needles should be used
 in **SINGER** Machines
 These Needles and their Containers
 are marked with the
 Company's Trade Mark "**SIMANCO.****" 1

Needles in Containers marked
 "**FOR SINGER MACHINES**"
 are NOT **SINGER** made needles. 2

LIST OF PARTS COMPLETE FOR MACHINE No. 147-61

FOR LAP SEAM FELLING SHIRT SLEEVES OF LIGHT WEIGHT MATERIALS, ALSO FOR TWO LINE STITCHING KNICKERS, PLAY SUITS, UPHOLSTERY, SEAT COVERS, KNIT UNDERWEAR, BATHING SUITS, ETC.

TWO NEEDLES, TWO LOOPERS. GAUGES $\frac{3}{2}$ IN. TO $\frac{1}{2}$ IN. NEEDLE BAR STROKE $1\frac{3}{2}$ INCHES. THE LOOPERS ARE ARRANGED SO THAT THEY MAY BE THROWN OUT OF POSITION FOR CONVENIENCE IN THREADING. AN IMPROVED OILING SYSTEM AUTOMATICALLY OILS ALL OF THE PRINCIPAL BEARINGS OF THE MACHINE. BALANCE WHEEL NO. 64259. DIAMETER OF BELT GROOVE 2 INCHES. SPEED 4000.

NO.	PLATE	NAME
*68427	----	Arm, upper and lower (solid) with 948J, 68483 and four 131022.....
68428	9917	Arm Bottom Cover.....
68429	9917	" " " Gasket (cork).....
1057E	20503	" " " Screw.....
68350	9922	" Oil Cup, for oiling Arm Rock Shaft Front Bearing.....
68430	9922	Arm Oil Cup, for filling oil reservoir....
54648	9922	" " " Oil Pad (braided cotton) for 68350.....
68431	9916	Arm Rock Shaft.....
68432	----	" " " 68431 with 1235F and 68439.....
1309C	20504	Arm Rock Shaft Adjusting Screw.....
131056	20504	" " " " " Washer.....
68433	9916	" " " Bushing (back).....
68434	----	" " " " " 68433 with 52045.....
68435	9916	Arm Rock Shaft Bushing (back) Cap.....
131095	9916	" " " " " " Washer (fibre).....
52045	9922	Arm Rock Shaft Bushing (back) Oil Pad (wick).....
446C	20503	Arm Rock Shaft Bushing (back) Set Screw.....
68436	9916	Arm Rock Shaft Bushing (intermediate).....
68437	----	" " " " " 68436 with 52045.....

NO.	PLATE	NAME
52045	9922	Arm Rock Shaft Bushing (intermediate) Oil Pad (wick).....
423c	20503	Arm Rock Shaft Bushing (intermediate) Set Screw.....
131072	9916	Arm Rock Shaft Crank, back (ball bearing, solid) with two 50083c.....
50083c	20503	Arm Rock Shaft Crank (back) Set Screw.....
68439	9916	Arm Rock Shaft Crank (front) with 443c and 853c.....
2117	20504	Arm Rock Shaft Crank (front) Pin.....
443c	20503	“ “ “ “ “ Set Screw
54105	9916	“ “ “ Flanged Bushing (front).....
52045	9922	Arm Rock Shaft Flanged Bushing (front) Oil Pad (wick).....
453c	20503	Arm Rock Shaft Flanged Bushing (front) Set Screw.....
1235F	20503	Arm Rock Shaft Oil Plug Screw.....
42365	9922	“ “ “ “ Pad (braided cotton) for oiling Back Bearing.....
54969	9922	Arm Rock Shaft Oil Pad (braided cotton) for oiling Intermediate Bearing.....
131104	20508	Arm Rotary Shaft.....
NOTE: When No. 131104 is required for repairs, the Looper Driving Shaft and Feed Lifting Eccen- tric must be returned to the factory to be adjusted to the new part.		
131105	-----	Arm Rotary Shaft 131104 with 640E, 54450, 68459, 131108, 131111, 131184, and 131194.....
68442	20501	Arm Rotary Shaft Bushing (front).....
761E	20503	“ “ “ “ “ Set Screw.....
68443	9917	Arm Rotary Shaft Bushing (inter- mediate).....
68444	-----	Arm Rotary Shaft Bushing (inter- mediate) 68443 with 41128.....
41128	9922	Arm Rotary Shaft Bushing (inter- mediate) Oil Pad (braided cotton)...
422c	20503	Arm Rotary Shaft Bushing (inter- mediate) Set Screw (long).....
50084c	20503	Arm Rotary Shaft Bushing (inter- mediate) Set Screw (short).....
54450	20501	Arm Rotary Shaft Collar with two 1258c.....

NO.	PLATE	NAME
1258c	9925	Arm Rotary Shaft Collar Set Screw....
68445	9917	“ “ “ Flanged Bushing
68446	-----	“ “ “ “ “ 68445 with 42367.....
42367	9922	Arm Rotary Shaft Flanged Bushing Oil Pad (braided cotton).....
159E	20503	Arm Rotary Shaft Flanged Bushing Screw.....
42367	9922	Arm Rotary Shaft Front Bearing Oil Pad, lower (braided cotton).....
54218	9922	Arm Rotary Shaft Front Bearing Oil Pad, upper (braided cotton).....
57974	9922	Arm Rotary Shaft Oil Pad (braided cotton) for oiling Back Bearing.....
56006	9922	Arm Rotary Shaft Oil Pad (braided cotton) for oiling Intermediate Bear- ing.....
141D	20503	Arm Rotary Shaft Screw.....
68447	9917	“ Side Cover.....
68448	9917	“ “ “ Gasket (cork).....
1057J	20503	“ “ “ Screw.....
64259	20508	Balance Wheel, 2 in. pulley, with two 51283c.....
51283c	20503	Balance Wheel Set Screw.....
68449	20508	Cloth Plate.....
68368	9918	“ “ Slide (left).....
131050	9918	“ “ “ “ Spring.....
725J	20503	“ “ “ “ “ Screw...
131051	-----	Cloth Plate Slide (left) complete, Nos. 68368, 131050 and two 725J.....
54055	20507	Cloth Plate Slide (right) for 54056....
54057	20507	“ “ “ “ “ 54058....
68166	20507	“ “ “ “ “ 68167....
68191	20507	“ “ “ “ “ 68192....
131206	20507	“ “ “ “ “ 131207....
38419	20504	“ “ “ “ “ Spring.....
725J	20503	“ “ “ “ “ Screw..
54056	-----	Cloth Plate Slide (right) complete, for 68450, Nos. 38419, 54055 and two 725J.....
54058	-----	Cloth Plate Slide (right) complete, for 131114, Nos. 38419, 54057 and two 725J.....
68167	-----	Cloth Plate Slide (right) complete, for 131031, Nos. 38419, 68166 and two 725J.....

NO.	PLATE	NAME
68192	----	Cloth Plate Slide (right) complete, for 131216, Nos. 38419, 68191 and two 725J.....
131207	----	Cloth Plate Slide (right) complete, for 131208, Nos. 38419, 131206 and two 725J.....
68450	----	Cloth Plate complete, to be used with Throat Plates Nos. 131209 and 131210 when $\frac{3}{32}$ in. to $\frac{5}{32}$ in. gauges are required, and Throat Plates Nos. 131211 and 131212 for $\frac{3}{16}$ in. to $\frac{1}{4}$ in. gauges, Nos. 54056, 68449 and 131051
131031	----	Cloth Plate complete, to be used with Throat Plates Nos. 131211 and 131212 when $\frac{9}{32}$ in. and $\frac{5}{16}$ in. gauges are required, Nos. 68167, 68449 and 131051.....
131114	----	Cloth Plate complete, to be used with Throat Plates Nos. 131213 and 131214 when $\frac{1}{2}$ in. and $\frac{3}{8}$ in. gauges are required, Nos. 54058, 68449 and 131051.....
131208	----	Cloth Plate complete, to be used with Throat Plate No. 131115 when $\frac{1}{4}$ in. to $\frac{5}{16}$ in. gauges are required, and Throat Plates Nos. 131124 and 131215 for $\frac{1}{4}$ in. to $\frac{1}{2}$ in. gauges, Nos. 68449, 131051 and 131207.....
131216	----	Cloth Plate complete, to be used with Throat Plate No. 131115 when $\frac{1}{4}$ in. and $\frac{3}{8}$ in. gauges are required, Nos. 68192, 68449 and 131051.....
1011F	20503	Cloth Plate Screw (left).....
50396F	20503	" " " (right).....
131130	20508	" " Thread Guard.....
389F	20503	" " " " Screw (lower)
50473F	20503	" " " " " (upper)
68452	9916	Crank Connecting Rod (rod only).....
*68453	----	" " " " Cap (lower)....
896E	20503	" " " " " Screw
*54018	----	" " " " (upper)....
1057E	20503	" " " " " Screw
*68454	----	" " " " End Bearing (lower).....
*68455	----	Crank Connecting Rod End Bearing (upper).....

NO.	PLATE	NAME
68456	9916	Crank Connecting Rod Head (lower), Nos. 68453, 68454 and two 896E....
68457	9916	Crank Connecting Rod Head (upper), Nos. 54018, 68455 and two 1057E....
1722E	20503	Crank Connecting Rod Nut (lower)...
1723E	20503	" " " " (upper)...
68458	9916	Crank Connecting Rod complete, Nos. 1722E, 1723E, 68452, 68456 and 68457
68459	----	Crank Connecting Rod 68458 with 131072.....
68460	9918	Face Plate (lower half).....
68461	9918	" " " " Gasket (cork)...
330D	20503	" " " " Screw.....
68462	9918	" " (upper half).....
29234	20504	" " " " Position Plate
1053E	20504	" " " " " " " " Screw.....
286D	20503	Face Plate (upper half) Thumb Screw..
68463	9918	Feed Bar.....
68464	9918	Feed Bar complete, Nos. 50429c, 54648, 68463, 68467 and two 207E.....
131197	9918	Feed Bar Hinge Pin (eccentric).....
59343	9925	" " " " Collar with 735c...
735c	9925	" " " " " Set Screw...
54648	9922	" " Oil Pad (braided cotton)....
134258	9918	" " Slide Block.....
134259	9918	" " " " 134258 with 68495 and 134260.....
68495	9922	Feed Bar Slide Block Oil Pad (wick)...
134260	9922	" " " " " Retainer
68467	9918	" " Wearing Plate.....
207E	20503	" " " " " Screw.....
131106	20506	" " Connecting Rod with 1057E, 131090, 131107, 134260 and two 896E.....
131108	----	Feed Connecting Rod 131106 with 54025.....
*131107	----	Feed Connecting Rod Cap.....
896E	20503	" " " " " Screw.....
1057E	20503	" " " " Clamping Screw
131090	9922	" " " Oil Pad (wick)...
134260	9922	" " " " Retainer
131032	20510	" Dog, 17 teeth (16 teeth to the inch) for $\frac{3}{32}$ in. to $\frac{5}{32}$ in. gauges, for 131209 and 131210.....

NO.	PLATE	NAME
68472	20511	Feed Dog, 16 teeth (16 teeth to the inch) for $\frac{3}{16}$ in. to $\frac{5}{16}$ in. gauges, with row of teeth between the needles, for 131211 and 131212.....
68381	20518	Feed Dog, 17 teeth (14 teeth to the inch) for $\frac{1}{4}$ in. to $\frac{3}{8}$ in. gauges, for making longer stitch than regular, for 131115.....
131093	20512	Feed Dog, 16 teeth (16 teeth to the inch) for $\frac{1}{2}$ in. and $\frac{3}{8}$ in. gauges, for 131213 and 131214.....
131118	20517	Feed Dog, 16 teeth (14 teeth to the inch) for $\frac{1}{2}$ in. to $\frac{1}{2}$ in. gauges, for 131121 and 131215.....
157j	20503	Feed Dog Screw, when stationary Needle Guard is used.....
50073j	20503	Feed Dog Screw, when movable Needle Guard is used.....
50429c	20503	Feed Dog Stop Screw.....
*51021	-----	" Eccentric.....
*23729	-----	" " Body.....
51061c	20503	" " " Set Screw.....
7071	9925	" " " Clamping Washer.....
217j	20503	" " " " Screw.....
54025	20506	Feed Eccentric (adjustable) complete, Nos. 217j, 1103c, 7071, 23729, 54024 and two 51061c.....
1103c	20503	Feed Regulating Screw.....
131195	20502	" Rocking Frame with two 453c....
131196	-----	" " " 131195 with 59313, 68461 and 131197.....
57234	20502	Feed Rocking Frame Hinge Pin.....
57235	20501	" " " " " Bushing.....
453c	20503	Feed Rocking Frame Hinge Pin Bushing Set Screw.....
453c	20503	Feed Rocking Frame Hinge Pin Set Screw.....
68476	9919	Looper (back) closed eye, for lap seam felling.....
131131	9919	Looper (back) closed eye, for general work.....
NOTE: When ordering Nos. 68476 or 131131, state gauge of machine for which required.		
452c	9919	Looper (back) Set Screw.....
68477	9919	" (front) closed eye, for lap seam felling.....

NO.	PLATE	NAME
131132	9919	Looper (front) closed eye, for general work.....
NOTE: When ordering Nos. 68477 or 131132, state gauge of machine for which required.		
1120c	9919	Looper (front) Set Screw.....
54027	9919	" Carrier with two 175E.....
175E	9919	" " Adjusting Screw.....
54227	9919	" " Connection.....
54228	9919	" " " Shaft.....
128419	9922	" " " " Oil Pad (braided cotton).....
68478	9919	Looper Carrier Connection Shaft Sleeve (eccentric).....
51263d	9919	Looper Carrier Connection Shaft Sleeve Cap Screw.....
68479	9919	Looper Carrier Driver with 68480 and four 175E.....
*68480	-----	Looper Carrier Driver Cap.....
175E	9919	" " " " Screw.....
131110	20506	" Driving Shaft and Feed Lifting Eccentric with two 64315.....
NOTE: When No. 131110 is required for repairs, the Arm Rotary Shaft must be returned to the factory to be adjusted to the new part.		
131111	-----	Looper Driving Shaft and Feed Lifting Eccentric 131110 with 54027, 54227, 54228 and 68479.....
*68483	-----	Looper Driving Shaft and Feed Lifting Eccentric Bracket with 761E.....
948j	20503	Looper Driving Shaft and Feed Lifting Eccentric Bracket Screw.....
68484	20502	Looper Driving Shaft and Feed Lifting Eccentric Bushing.....
131028	9925	Looper Driving Shaft and Feed Lifting Eccentric Bushing Oil Plug.....
761E	20503	Looper Driving Shaft and Feed Lifting Eccentric Bushing Position Screw....
68497	9922	Looper Driving Shaft and Feed Lifting Eccentric Front Bearing Oil Pad (wick)
64315	9925	Looper Driving Shaft and Feed Lifting Eccentric Oil Hole Plug.....
640E	20503	Looper Driving Shaft and Feed Lifting Eccentric Screw.....
131052	9919	Looper Holder with 452c and 1120c....
51119j	20503	" " Screw.....

NO.	PLATE	NAME
68485	20502	Looper Throw-out Handle with two 443c
68486	20502	“ “ “ Plunger
43503	20504	“ “ “ “ Spring
443c	20503	“ “ “ “ Set Screw
64319	9923	Needle Bar (hollow)
131045	—	Needle Bar complete, for $\frac{3}{2}$ in. to $\frac{1}{2}$ in. gauges, Nos. 64319 and 131044
68487	9923	Needle Bar Bushing (lower)
1133E	9923	“ “ “ “ Set Screw
64320	9923	“ “ “ “ (upper)
1133E	9923	“ “ “ “ Set Screw
68488	9923	“ “ Connecting Link and Thread (upper) Controller
131047	—	Needle Bar Connecting Link and Thread (upper) Controller 68488 with 68490 and 68491
68489	9923	Needle Bar Connecting Link Hinge Stud (hollow)
68490	—	Needle Bar Connecting Link Hinge Stud 68489 with 861c and 130007
1520j	9923	Needle Bar Connecting Link Hinge Stud Nut
130007	9923	Needle Bar Connecting Link Hinge Stud Oil Pad (wick)
861c	9923	Needle Bar Connecting Link Hinge Stud Oil Plug Screw
853j	9923	Needle Bar Connecting Link Hinge Stud Set Screw
68491	9923	Needle Bar Connecting Stud with 211f and two 187E
187E	9923	Needle Bar Connecting Stud Clamping Screw
131044	9923	Needle Clamp with two 1498E, for $\frac{3}{2}$ in. to $\frac{1}{2}$ in. gauges
131174	9920	Needle Guard (movable) for $\frac{3}{8}$ in. gauge
131121	9920	Needle Guard (movable) for $\frac{1}{2}$ in. to $\frac{1}{2}$ in. gauges
68123	9920	Needle Guard (movable) Clamp
54067	9920	“ “ (stationary) for $\frac{3}{2}$ in. to $\frac{5}{2}$ in. gauges
54068	9920	Needle Guard (stationary) for $\frac{3}{8}$ in. to $\frac{3}{2}$ in. gauges
54069	9920	Needle Guard (stationary) for $\frac{5}{8}$ in. to $\frac{3}{8}$ in. gauges
131175	9920	Needle Guard (stationary) for $\frac{3}{8}$ in. to $\frac{1}{2}$ in. gauges

NO.	PLATE	NAME
54038	9920	Needle Guard (stationary) Holder
176j	20503	“ “ “ “ Screw
217c	20503	“ “ “ “ Screw
1498F	9923	“ Set Screw
68492	9921	Oil Pipe (back of arm) with 49191 and 68497, for oiling Feed Rocking Frame Hinge Pin Front Bearing
68493	9921	Oil Pipe (back of arm) Clamp
176E	20503	“ “ “ “ “ “ Screw
68494	9921	“ “ “ “ “ “ Connection with 49189, 68495 and two 198E, for oiling Feed Rocking Frame Hinge Pin Back Bearing
*49189	—	Oil Pipe (back of arm) Connection Cap
198E	9925	“ “ “ “ “ “ “ “ Screw
68495	9922	Oil Pipe (back of arm) Connection Oil Pad (wick)
68496	9921	Oil Pipe (back of arm) Coupling
1733	9925	“ “ “ “ “ “ “ Nut (brass)
68497	9922	Oil Pipe (back of arm) Oil Pad (wick)
*49191	—	“ “ “ “ “ “ Sleeve
68498	9921	“ “ (front of arm) with two each 1733, 49191 and 131089, for oiling Looper Driving Shaft and Feed Lifting Eccentric Front Bearing
131112	9921	Oil Pipe (front of arm) with 68497 and 131003, for oiling Feed Bar Slide Block
68500	9921	Oil Pipe (front of arm) with 1733, 49191, 131084 and 131089, for oiling Arm Rotary Shaft Front Bearing
131113	9921	Oil Pipe (front of arm) with 68497 and 131003, for oiling Feed Connecting Rod
131002	9921	Oil Pipe (front of arm) Connection with 131049 and two 198E, for oiling Looper Throw-out Device
131003	9921	Oil Pipe (front of arm) Connection with 49189 and two 198E, for 131112 and 131113
131084	9921	Oil Pipe (front of arm) Connection with 131085 and two 198E, for 68500
*49189	—	Oil Pipe (front of arm) Connection Cap for 131003

NO.	PLATE	NAME
*131049	-----	Oil Pipe (front of arm) Connection Cap for 131002.....
*131085	-----	Oil Pipe (front of arm) Connection Cap for 131084.....
198E	9925	Oil Pipe (front of arm) Connection Cap Screw.....
131004	9921	Oil Pipe (front of arm) Coupling (center).....
131004	9921	Oil Pipe (front of arm) Coupling (left).....
*131086	-----	Oil Pipe (front of arm) Coupling (right).....
131087	9921	Oil Pipe (front of arm) Coupling (right) 131086 with 131088.....
*131088	-----	Oil Pipe (front of arm) Coupling (right) Oil Lead.....
1733	9925	Oil Pipe (front of arm) Coupling Nut (brass).....
131089	9922	Oil Pipe (front of arm) Oil Pad (wick) for 68498 and 68500.....
68497	9922	Oil Pipe (front of arm) Oil Pad (wick) for 131112 and 131113.....
*49191	-----	Oil Pipe (front of arm) Sleeve.....
64330	20502	Presser Bar with 25303.....
25303	9923	" " Ball, size $\frac{1}{4}$ in.....
131006	9923	" " Bushing (lower).....
1133E	9923	" " " " Set Screw.....
38456	9923	" " " (upper).....
1133E	9923	" " " " Set Screw.....
54039	9920	" " Guide Bracket with 453c, 640j and 1963.....
640j	20503	Presser Bar Guide Bracket Adjusting Screw.....
11173	9920	Presser Bar Guide Bracket Guide.....
447c	9920	" " " " " " Set Screw.....
1963	9920	Presser Bar Guide Bracket Roller and Stud.....
453c	20503	Presser Bar Guide Bracket Set Screw...
57257	20504	" " Lifter.....
50592c	20504	" " " Hinge Screw.....
1250c	20504	" " " Stop Screw.....
131007	9920	" " Lifting Bracket with 462c..
131008	9920	" " " " Connection
61075	9920	" " " " " "
		Connecting Pin.....

NO.	PLATE	NAME
462c	9920	Presser Bar Lifting Bracket Connection Connecting Pin Set Screw.....
131009	20502	Presser Bar Lifting Lever.....
68184	20502	" " " " Extension (back).....
161j	20504	Presser Bar Lifting Lever Extension (back) Screw.....
131010	20502	Presser Bar Lifting Lever Extension (front).....
176j	20503	Presser Bar Lifting Lever Extension (front) Screw.....
802D	20504	Presser Bar Lifting Lever Hinge Screw.
38467	20502	" " Spring (flat).....
38468	9925	" " Stud.....
26276	20511	" Foot Hinge Pin.....
120352	-----	" " Plate.....
46087	-----	" " Shank.....
120353	20510	Presser Foot (hinged) complete, to be used with Feed Dog No. 131032 when $\frac{3}{2}$ in. to $\frac{5}{2}$ in. gauges are required, and Feed Dog No. 68381 for $\frac{1}{4}$ in. to $\frac{3}{8}$ in. gauges, for lap seam felling, Nos. 26276, 46087 and 120352.....
26276	20511	Presser Foot Hinge Pin.....
131158	-----	" " Plate.....
54120	-----	" " Shank.....
131159	20511	Presser Foot (hinged) complete, for $\frac{3}{2}$ in. to $\frac{3}{8}$ in. gauges, for lap seam felling, Nos. 26276, 54120 and 131158
NOTE: Presser Foot No. 131159 is regularly furnished with this machine unless another Presser Foot is specified on order.		
26276	20511	Presser Foot Hinge Pin.....
131161	-----	" " Plate.....
54120	-----	" " Shank.....
131162	20513	Presser Foot (hinged) complete, for $\frac{3}{8}$ in. to $\frac{1}{2}$ in. gauges, for lap seam felling, Nos. 26276, 54120 and 131161
26276	20511	Presser Foot Hinge Pin.....
131164	-----	" " Plate.....
46087	-----	" " Shank.....
131165	20510	Presser Foot (hinged) complete, for $\frac{3}{2}$ in. to $\frac{3}{8}$ in. gauges, for plain stitching, Nos. 26276, 46087 and 131164.....

NO.	PLATE	NAME
26276	20511	Presser Foot Hinge Pin.....
131122	-----	" " Plate.....
36030	-----	" " Shank.....
131123	20517	Presser Foot (hinged) complete, for 3/4 in. to 1/2 in. gauges, for plain stitching, Nos. 26276, 36030 and 131122.....
190J	9925	Presser Foot Screw.....
574w	9925	Pressure Regulating Thumb Screw....
1539w	9925	" " " " Lock Nut.....
131025	9925	Slack Thread Controller.....
54242	9925	" " " Clamp.....
190J	9925	" " " " Screw..
64337	9925	" " Regulator.....
54042	9925	" " " Holder with 175E and two 50150c.....
175E	9919	Slack Thread Regulator Holder Clamp- ing Screw.....
131042	9925	Slack Thread Regulator Holder Shaft
24292	9925	" " " " " Collar with 1019c.....
1019c	9925	Slack Thread Regulator Holder Shaft Collar Set Screw.....
54044	9920	Slack Thread Regulator Holder Shaft Crank (forked) with 1253c.....
1253c	9920	Slack Thread Regulator Holder Shaft Crank Set Screw.....
50150c	9925	Slack Thread Regulator Set Screw....
131012	20502	Tension (under thread) Bracket.....
691F	9924	" " " " Screw..
2102	9924	" " " Disc.....
51570c	9924	" " " Regulating Thumb Nut.....
50326c	9924	Tension (under thread) Screw Stud....
59539	-----	" " " " " 50326c with 51570c.....
59534	9924	Tension (under thread) Spring.....
59537	9924	" " " " Bushing (large).....
59538	9924	Tension (under thread) Spring Bushing (small).....
17547	9924	Tension (under thread) Thread Guide..
54070	20506	" (upper thread) Bracket.....
376J	9924	" " " " Screw..
2102	9924	" " " Disc.....

NO.	PLATE	NAME
51570c	9924	Tension (upper thread) Regulating Thumb Nut.....
32572	9924	Tension (upper thread) Releasing Disc..
54988	9924	" " " " Pin..
54071	20506	" " " " Shaft
54047	9924	" " " " " Crank with 624c.....
54048	9924	Tension (upper thread) Releasing Shaft Crank Link.....
624c	9924	Tension (upper thread) Releasing Shaft Crank Set Screw.....
68261	9924	Tension (upper thread) Releasing Shaft Spring.....
131011	9924	Tension (upper thread) Releasing Shaft Spring Position Plate.....
316c	9924	Tension (upper thread) Releasing Shaft Stop Screw.....
1517J	9924	Tension (upper thread) Releasing Shaft Stop Screw Nut.....
50326c	9924	Tension (upper thread) Screw Stud....
59539	-----	" " " " " 50326c with 51570c.....
59535	9924	Tension (upper thread) Spring.....
59537	9924	" " " " Bushing (large).....
59538	9924	Tension (upper thread) Spring Bushing (small).....
57076	9924	Tension (upper thread) Thread Guide (double).....
53225	9924	Thread (under) Eyelet (back).....
190J	9925	" " " " Screw..
51072	20501	" " " (front).....
131184	20501	" " Nipper Cam with 465c.
465c	9925	" " " " Set Screw
38210	20501	" " " Spring (lower)..
38211	20501	" " " " (upper)
46247	20501	" " " " " Stop.....
176J	20503	Thread (under) Nipper Spring Screw..
131014	9925	" " Take-up with two 465c
465c	9925	" " " Set Screw....
54435	9925	" " " Staple with 590E and 38481.....
131157	20506	Thread (under) Take-up Staple Bracket with 460c.....
965D	20504	Thread (under) Take-up Staple Bracket Screw.....

NO.	PLATE	NAME
46041	20501	Thread (under) Take-up Staple Spring
190j	9925	" " " " " "
		Screw.....
38481	9925	Thread (under) Take-up Staple Thread Guard.....
590E	9925	Thread (under) Take-up Staple Thread Guard Screw.....
131096	20501	Thread (under) Take-up Stripper.....
190j	9925	" " " " " Screw.....
131194	20501	" " " " Thread Guard (brass).....
61356	20501	Thread (under) Take-up Thread Guard Steady Pin.....
460c	20501	Thread (under) Take-up Thread Guard Steady Pin Set Screw.....
46009	20501	Thread (upper) Eyelet.....
190j	9925	" " " " Screw.....
54094	20501	" " " " Take-up.....
54095	20501	" " " " Plate.....
68164	20501	" " " " Spring...
1449j	20501	" " " " Screw
54096	-----	Thread (upper) Take-up complete, Nos. 1449j, 54094, 54095 and 68164.....
211F	9923	Thread (upper) Take-up Set Screw.....
131209	20514	Throat Plate, for $\frac{3}{8}$ in. to $\frac{5}{8}$ in. gauges, for 131032, for lap seam felling.....
131211	20515	Throat Plate, for $\frac{1}{8}$ in. to $\frac{1}{4}$ in. gauges, for 68472, for lap seam felling.....
131115	20518	Throat Plate, for $\frac{1}{4}$ in. to $\frac{3}{8}$ in. gauges, for 68381, for lap seam felling, for making longer stitch than regular....
131213	20516	Throat Plate, for $\frac{1}{2}$ in. and $\frac{3}{8}$ in. gauges, for 131093, for lap seam felling.....
131124	20517	Throat Plate, for $\frac{1}{2}$ in. to $\frac{1}{2}$ in. gauges, for 131118, for lap seam felling.....
131210	20514	Throat Plate, for $\frac{3}{8}$ in. to $\frac{5}{8}$ in. gauges, for 131032, for plain stitching.....
131212	20515	Throat Plate, for $\frac{1}{8}$ in. to $\frac{5}{8}$ in. gauges, for 68472, for plain stitching.....
131214	20516	Throat Plate, for $\frac{1}{2}$ in. and $\frac{3}{8}$ in. gauges, for 131093, for plain stitching
131215	20517	Throat Plate, for $\frac{1}{2}$ in. to $\frac{1}{2}$ in. gauges, for 131118, for plain stitching.....
742F	20504	Throat Plate Screw.....

**FITTINGS FOR 147-60 MACHINE
FOR LAP SEAM FELLING—Lap Seam Feller No. 120906**

	$\frac{3}{32}$	$\frac{1}{8}$	$\frac{3}{32}$	$\frac{1}{4}$	$\frac{5}{32}$	$\frac{3}{16}$	$\frac{1}{2}$	$\frac{5}{8}$	$\frac{3}{4}$	$\frac{7}{8}$	$1\frac{1}{2}$	$1\frac{3}{4}$	$1\frac{1}{2}$	$1\frac{3}{4}$	$1\frac{1}{2}$
Feed Dog	131032	131032	68472	68472	68472	68472	131093	131093	131160	131160	131160	131160	131160	131160	131160
"	68476	68476	68476	68476	68476	68476	68476	68476	68476	68476	68476	68476	68476	68476	68476
Looper (back)	68477	68477	68477	68477	68477	68477	68477	68477	68477	68477	68477	68477	68477	68477	68477
Looper (front)	131045	131045	131045	131045	131045	131045	131045	131045	131045	131045	131045	131045	131045	131045	131045
Needle Bar	54067	54067	54067	54068	54068	54068	54069	54069	54069	54069	54069	54069	54069	54069	54069
Needle Guard (stationary)	120353	120353	120353	131159	131159	131159	131159	131159	131159	131159	131159	131159	131159	131159	131159
Needle Guard (movable)	131033	131033	131033	131017	131017	131017	131017	131017	131017	131017	131017	131017	131017	131017	131017
Presser Foot	131033	131033	131033	131017	131017	131017	131017	131017	131017	131017	131017	131017	131017	131017	131017
"	131033	131033	131033	131017	131017	131017	131017	131017	131017	131017	131017	131017	131017	131017	131017
Throat Plate	131032	131032	68472	68472	68472	68472	131093	131093	131160	131160	131160	131160	131160	131160	131160
"	131131	131131	131131	131131	131131	131131	131131	131131	131131	131131	131131	131131	131131	131131	131131
Looper (back)	131132	131132	131132	131132	131132	131132	131132	131132	131132	131132	131132	131132	131132	131132	131132
Looper (front)	131045	131045	131045	131045	131045	131045	131045	131045	131045	131045	131045	131045	131045	131045	131045
Needle Bar	54067	54067	54067	54068	54068	54068	54069	54069	54069	54069	54069	54069	54069	54069	54069
Needle Guard (stationary)	131165	131165	131165	131165	131165	131165	131165	131165	131165	131165	131165	131165	131165	131165	131165
Needle Guard (movable)	131172	131172	131172	131173	131173	131173	131173	131173	131173	131173	131173	131173	131173	131173	131173
Presser Foot	131172	131172	131172	131173	131173	131173	131173	131173	131173	131173	131173	131173	131173	131173	131173
Throat Plate	131032	131032	68472	68472	68472	68472	131093	131093	131160	131160	131160	131160	131160	131160	131160
"	131131	131131	131131	131131	131131	131131	131131	131131	131131	131131	131131	131131	131131	131131	131131
Looper (back)	131132	131132	131132	131132	131132	131132	131132	131132	131132	131132	131132	131132	131132	131132	131132
Looper (front)	131045	131045	131045	131045	131045	131045	131045	131045	131045	131045	131045	131045	131045	131045	131045
Needle Bar	54067	54067	54067	54068	54068	54068	54069	54069	54069	54069	54069	54069	54069	54069	54069
Needle Guard (stationary)	131165	131165	131165	131165	131165	131165	131165	131165	131165	131165	131165	131165	131165	131165	131165
Needle Guard (movable)	131172	131172	131172	131173	131173	131173	131173	131173	131173	131173	131173	131173	131173	131173	131173
Presser Foot	131172	131172	131172	131173	131173	131173	131173	131173	131173	131173	131173	131173	131173	131173	131173
Throat Plate	131032	131032	68472	68472	68472	68472	131094	131094	131166	131166	131166	131166	131166	131166	131166
"	131131	131131	131131	131131	131131	131131	131131	131131	131131	131131	131131	131131	131131	131131	131131

FOR PLAIN STITCHING

Feed Dog	131032	131032	68472	68472	68472	68472	131093	131093	131160	131160	131160	131160	131160	131160	131160
"	131131	131131	131131	131131	131131	131131	131131	131131	131131	131131	131131	131131	131131	131131	131131
Looper (back)	131132	131132	131132	131132	131132	131132	131132	131132	131132	131132	131132	131132	131132	131132	131132
Looper (front)	131045	131045	131045	131045	131045	131045	131045	131045	131045	131045	131045	131045	131045	131045	131045
Needle Bar	54067	54067	54067	54068	54068	54068	54069	54069	54069	54069	54069	54069	54069	54069	54069
Needle Guard (stationary)	131165	131165	131165	131165	131165	131165	131165	131165	131165	131165	131165	131165	131165	131165	131165
Needle Guard (movable)	131172	131172	131172	131173	131173	131173	131173	131173	131173	131173	131173	131173	131173	131173	131173
Presser Foot	131172	131172	131172	131173	131173	131173	131173	131173	131173	131173	131173	131173	131173	131173	131173
Throat Plate	131032	131032	68472	68472	68472	68472	131094	131094	131166	131166	131166	131166	131166	131166	131166
"	131131	131131	131131	131131	131131	131131	131131	131131	131131	131131	131131	131131	131131	131131	131131

NOTE: Where gauges overlap, regular fittings are designated by an asterisk (*).
NOTE: When movable Needle Guard is used, Needle Guard Clamp 68123 and Feed Dog Screw No. 50073j are also required.

**FITTINGS FOR 147-61 MACHINE
FOR LAP SEAM FELLING—Lap Seam Feller No. 120848**

	$\frac{3}{32}$	$\frac{1}{8}$	$\frac{5}{32}$	$\frac{3}{16}$	$\frac{1}{4}$	$\frac{9}{32}$	$\frac{5}{16}$	$\frac{3}{8}$	$\frac{7}{16}$	$\frac{1}{2}$
Feed Dog	131032	131032	131032	68472	*68472	*68472	*68472	*131093	131118	131118
"	68476	68476	68476	68472	68381	68381	68381	68381	68476	68476
Looper (back)	68476	68476	68476	68476	68476	68476	68476	68476	68476	68476
Looper (front)	68477	68477	68477	68477	68477	68477	68477	68477	68477	68477
Needle Bar	131045	131045	131045	131045	131045	131045	131045	131045	131045	131045
Needle Guard (stationary)	54067	54067	54067	54068	54068	54069	54069	54069	54069	54069
Needle Guard (movable)										
Presser Foot										
"										
"										
Throat Plate	120353	120353	120353	131159	131159	120353	120353	120353	131162	131162
"										
"	131209	131209	131209	131211	131211	*131211	*131211	*131213	131124	131124

FOR PLAIN STITCHING

Feed Dog	131032	131032	131032	68472	68472	68472	68472	131093	131118	131118
Looper (back)	131131	131131	131131	131131	131131	131131	131131	131131	131131	131131
Looper (front)	131132	131132	131132	131132	131132	131132	131132	131132	131132	131132
Needle Bar	131045	131045	131045	131045	131045	131045	131045	131045	131045	131045
Needle Guard (stationary)	54067	54067	54067	54068	54068	54069	54069	54069	54069	54069
Needle Guard (movable)										
Presser Foot	131165	131165	131165	131165	131165	131165	131165	131165	131165	131165
Throat Plate	131210	131210	131210	131212	131212	131212	131212	131214	131214	131214

NOTE: Where gauges overlap, regular fittings are designated by an asterisk (*).
NOTE: When movable Needle Guard is used, Needle Guard Clamp 68123 and Feed Dog Screw No. 50073j are also required.

ACCESSORIES

NO.	PLATE	NAME
120344	8941	Oiler (copper plated) with 120345.....
120345	8941	" Spout, 5 in. long.....
26026	8941	Screw Driver (large).....
26485	8941	" " (small).....
38487	8941	Threading Wire.....
120341	8941	Tweezers (curved).....
4822	8941	Wrench for 1517.....
8908	8941	" " 1520.....

BELT GUARD

NO.	PLATE	NAME
68222	20509	Belt Guard with two wood screws 1 in. No. 12.....

BENCH STAND

NO.	PLATE	NAME
79772	----	Bench Stand with 27998, two each 41538, 124500, three wood screws 1 1/4 in. No. 14 and four each 60656 and wood screws 5/8 in. No. 7.....
124500	20505	Flap Hinge.....
27998	20505	" Hook and Eye (brass) with wood screw 1/2 in. No. 5.....
126247	20505	Flush Bolt.....
126248	20505	" " Plate.....
41538	----	Flush Bolt with Plate complete, Nos. 126247, 126248 and four brass wood screws 5/8 in. No. 4.....
60656	20505	Hinge.....

LAP SEAM FELLERS

NO.	PLATE	NAME
120906	20519	Lap Seam Feller on Shank, for sleeving, for light or medium weight material, for 147-60 Machine.....
120848	20519	Lap Seam Feller on Shank, for medium heavy and heavy weight material, for 147-61 Machine.....
1174F	20519	Lap Seam Feller Screw.....

FOOT LIFTER PARTS

NO.	PLATE	NAME
6439	-----	Chain, 36 in. to 45 in., with 56864 and 56865.....
NOTE: When ordering No. 6439, state length required.		
4879	8941	Chain Connecting Link.....
56864	8941	" Hook (large).....
56865	20505	" " (small).....
126249	20509	Treadle.....
4882	8941	" Shaft.....
126250	8941	" Spring.....
126251	20509	" Stand.....
126252	20509	Treadle complete, Nos. 4882, 126249 to 126251 and two wood screws 1 in. No. 16.....

KNEE LIFTER PARTS

NO.	PLATE	NAME
37563	-----	Chain, length 15 in., with 56864 and 56865.....
56864	8941	Chain Hook (large).....
56865	20505	" " (small).....
2763	20508	Rock Shaft.....
12242	20508	" " Hanger with two wood screws 1 in. No. 10.....
6335	20508	Rock Shaft Knee Arm.....
6336	-----	Rock Shaft Knee Arm complete, Nos. 2766, 2767 and 6335.....
2766	20508	Rock Shaft Knee Arm Hub with 356c..
356c	20504	" " " " " Set Screw..
2767	20508	" " " Plate with 356c.....
356c	20504	" " " " Set Screw.....
6337	20508	" " Lifting Bracket with two 356c.....
7125	20508	Rock Shaft Lifting Bracket Hook.....
356c	20504	" " " " " S e t Screw.....
356c	20504	Rock Shaft Lifting Bracket Set Screw..
2770	20508	" " Stop Dog with 356c.....
356c	20504	" " " " Set Screw.....
23767	20508	Rock Shaft complete, Nos. 2763, 2770, 6336, 6337, 7125 and two 12242.....

MACHINE BASE

NO.	PLATE	NAME
131018	20509	Machine Base.....
131019	20505	" " Oil Pipe.....
131020	20505	" " " " Valve.....
54477	20504	" " Screw Stud, to fasten base to table.. ..
131205	20504	Machine Base Screw Stud, to position machine on base.....
51576E	20504	Machine Base Screw Stud Nut.....
9842	20504	" " " " Washer
131022	20504	" " " " B u s h i n g (rubber).....
57285	20506	Machine Cushion (felt).....
131024	-----	Machine Base complete, Nos. 131018 to 131020, three each 9842, 51576E, 54477 and four each 57285 and 131205

THREAD UNWINDER

FOR FOUR SPOOLS

NO.	PLATE	NAME
225395	9505	Spool Rest (for two spools) with 201018c
150203	20509	" " Cushion.....
225388	9505	" " Rod.....
200383c	9925	" " " Set Screw.....
201018c	20504	" " Set Screw.....
202490	9505	" Stand with 200383c.....
225391	9505	Thread Guide.....
201696J	20504	" " Lock Nut.....
225326	20504	" " Position Cup.....
225324	9505	" " Rod with 208E and 225322
208E	9925	" " " Screw.....
225322	20504	" " " Washer.....
*150057	-----	" Separator
150058	9505	" " 150057 with 150059..
*150059	-----	" " Bracket.....
150060	9505	" " " Arm with 164J and 9525.....
164J	20504	Thread Separator Bracket Arm Clamping Screw.....
9525	9925	Thread Separator Bracket Arm Clamping Screw Washer.....

THREAD UNWINDER

NO.	PLATE	NAME
164J	20504	Thread Separator Bracket Arm Screw
9525	9925	“ “ “ “ “
		Washer.....
150061	---	Thread Separator complete, Nos. 164J, 9525, 150058 and 150060
150062	9505	Thread Unwinder complete, for four spools, Nos. 150061, 201696J, 202490, 225324, 225326, 225388, two 225395, three wood screws 1/8 in. No. 12 and four each 150203 and 225391.....
27739	20506	Thread Cone (wood) for large cones....
225390	20506	“ “ Holder, for inverted cones

NOTE: Nos. 27739 and 225390 are used with, but not included in 150062.

SINGER Needles should be used
in SINGER Machines
These Needles and their Containers
are marked with the
Company's Trade Mark "SIMANCO.**" 1

Needles in Containers marked
"FOR SINGER MACHINES"
are NOT SINGER made needles. 2

NUMERICAL LIST OF PARTS

NO.	PLATE	NAME
144D	20503	Arm Rotary Shaft Screw.....
157J	20503	Feed Dog Screw when stationary Needle Guard is used.....
159E	20503	Arm Rotary Shaft Flanged Bushing Screw.....
161J	20504	Presser Bar Lifting Lever Extension (back) Screw
164J	20504	Thread Unwinder Thread Separator Bracket Arm Clamping Screw for 150060.....
164J	20504	Thread Unwinder Thread Separator Bracket Arm Screw for 150061.....
175E	9919	Looper Carrier Adjusting Screw for 54027.....
175E	9919	Looper Carrier Driver Cap Screw for 68479
175E	9919	Slack Thread Regulator Holder Clamp- ing Screw for 54042.....
176E	20503	Oil Pipe (back of arm) Clamp Screw...
176J	20503	Feed Connecting Rod Cover Screw for 147-60 Machine.....
176J	20503	Needle Guard (stationary) Holder Screw
176J	20503	Presser Bar Lifting Lever Extension (front) Screw.....
176J	20503	Thread (under) Nipper Spring Screw for 147-61 Machine.....
187E	9923	Needle Bar Connecting Stud Clamping Screw for 68491.....
190J	9925	Presser Foot Screw.....
190J	9925	Slack Thread Controller Clamp Screw..
190J	9925	Thread (under) Eyelet (back) Screw...
190J	9925	“ “ Take-up Staple Spring Screw.....
190J	9925	Thread (under) Take-up Stripper Screw
190J	9925	“ (upper) Eyelet Screw.....
198E	9925	Oil Pipe (back of arm) Connection Cap Screw for 68494.....
198E	9925	Oil Pipe (front of arm) Connection Cap Screw for 131002, 131003 and 131084
207E	20503	Feed Bar Wearing Plate Screw for 68464
208E	9925	Thread Unwinder Thread Guide Rod Screw for 225324.....
211F	9923	Thread (upper) Take-up Set Screw for 68491.....

NO.	PLATE	NAME
217c	20503	Needle Guard (stationary) Screw.....
217j	20503	Feed Eccentric Clamping Washer Screw for 54025 and 68474.....
286d	20503	Face Plate (upper half) Thumb Screw
316c	9924	Tension (upper thread) Releasing Shaft Stop Screw.....
330d	20503	Face Plate (lower half) Screw.....
356c	20504	Rock Shaft Knee Arm Hub Set Screw for 2766.....
356c	20504	Rock Shaft Knee Plate Set Screw for 2767.....
356c	20504	Rock Shaft Lifting Bracket Hook Set Screw for 6337.....
356c	20504	Rock Shaft Lifting Bracket Set Screw for 6337.....
356c	20504	Rock Shaft Stop Dog Set Screw for 2770
376j	9924	Tension (upper thread) Bracket Screw..
389f	20503	Cloth Plate Thread Guard Screw (lower)
422c	20503	Arm Rotary Shaft Bushing (inter- mediate) Set Screw (long).....
423c	20503	Arm Rock Shaft Bushing (intermediate) Set Screw.....
443c	20503	Arm Rock Shaft Crank (front) Set Screw for 68439.....
443c	20503	Looper Throw-out Handle Set Screw for 68485.....
446c	20503	Arm Rock Shaft Bushing (back) Set Screw.....
447c	9920	Presser Bar Guide Bracket Guide Set Screw.....
452c	9919	Looper (back) Set Screw for 131052....
453c	20503	Arm Rock Shaft Flanged Bushing (front) Set Screw.....
453c	20503	Feed Rocking Frame Hinge Pin Bushing Set Screw.....
453c	20503	Feed Rocking Frame Hinge Pin Set Screw for 131195.....
453c	20503	Presser Bar Guide Bracket Set Screw for 54039.....
460c	20501	Thread (under) Take-up Thread Guard Steady Pin Set Screw for 131157.....
462c	9920	Presser Bar Lifting Bracket Connection Connecting Pin Set Screw for 131007
465c	9925	Thread (under) Take-up Set Screw for 131014.....
465c	9925	Thread (under) Nipper Cam Set Screw for 131184.....

NO.	PLATE	NAME
574w	9925	Pressure Regulating Thumb Screw.....
590e	9925	Thread (under) Take-up Staple Thread Guard Screw for 54435.....
621c	9924	Tension (upper thread) Releasing Shaft Crank Set Screw for 54047.....
640e	20503	Looper Driving Shaft and Feed Lifting Eccentric Screw for 68441 and 131105
640j	20503	Presser Bar Guide Bracket Adjusting Screw for 54039.....
691f	9924	Tension (under thread) Bracket Screw.
725j	20503	Cloth Plate Slide (left) Spring Screw for 131051.....
725j	20503	Cloth Plate Slide (right) Spring Screw for 54056, 54058, 68167, 68192 and 131207.....
735c	9925	Feed Bar Hinge Pin Collar Set Screw for 59343.....
742f	20504	Throat Plate Screw.....
761e	20503	Arm Rotary Shaft Bushing (front) Set Screw.....
761e	20503	Looper Driving Shaft and Feed Lifting Eccentric Bushing Position Screw for 68483.....
802d	20504	Presser Bar Lifting Lever Hinge Screw
853c	9923	Needle Bar Connecting Link Hinge Stud Set Screw for 68439.....
861c	9923	Needle Bar Connecting Link Hinge Stud Oil Plug Screw for 68490.....
896e	20503	Crank Connecting Rod Cap (lower) Screw for 68456.....
896e	20503	Feed Connecting Rod Cap Screw for 68468 and 131106.....
948j	20503	Looper Driving Shaft and Feed Lifting Eccentric Bracket Screw for 68427...
965d	20504	Thread (under) Take-up Staple Bracket Screw.....
1011f	20503	Cloth Plate Screw (left).....
1019c	9925	Slack Thread Regulator Holder Shaft Collar Set Screw for 24292.....
1053e	20504	Face Plate (upper half) Position Plate Screw.....
1057e	20503	Arm Bottom Cover Screw.....
1057e	20503	Crank Connecting Rod Cap (upper) Screw for 68457.....
1057e	20503	Feed Connecting Rod Clamping Screw for 68468 and 131106.....
1057j	20503	Arm Side Cover Screw.....

NO.	PLATE	NAME
1103c	20503	Feed Regulating Screw for 54025 and 68474.....
1120c	9919	Looper (front) Set Screw for 131052....
1133E	9923	Needle Bar Bushing (lower) Set Screw
1133E	9923	“ “ “ (upper) Set Screw
1133E	9923	Presser Bar Bushing (lower) Set Screw.
1133E	9923	“ “ “ (upper) Set Screw
1174F	20519	Lap Seam Feller Screw.....
1235F	20503	Arm Rock Shaft Oil Plug Screw for 68432.....
1250C	20504	Presser Bar Lifter Stop Screw.....
1253C	9920	Slack Thread Regulator Holder Shaft Crank Set Screw for 54044.....
1258C	9925	Arm Rotary Shaft Collar Set Screw for 54450.....
1309C	20504	Arm Rock Shaft Adjusting Screw.....
1449J	20501	Thread (upper) Take-up Plate Spring Screw for 54096.....
1498F	9923	Needle Set Screw for 131044.....
1520J	9923	“ Bar Connecting Link Hinge Stud Nut.....
1539w	9925	Pressure Regulating Thumb Screw Lock Nut.....
1547J	9924	Tension (upper thread) Releasing Shaft Stop Screw Nut.....
1722E	20503	Crank Connecting Rod Nut (lower) for 68458.....
1723E	20503	Crank Connecting Rod Nut (upper) for 68458.....
1733	9925	Oil Pipe (back of arm) Coupling Nut (brass).....
1733	9925	Oil Pipe (front of arm) Coupling Nut (brass) for 68498 and 68500.....
1963	9920	Presser Bar Guide Bracket Roller and Stud for 54039.....
2102	9924	Tension (under thread) Disc.....
2102	9924	“ (upper thread) Disc.....
2117	20504	Arm Rock Shaft Crank (front) Pin.....
2763	20508	Rock Shaft for 23767.....
2766	20508	“ “ Knee Arm Hub with 356c, for 6336.....
2767	20508	Rock Shaft Knee Plate with 356c, for 6336.....
2770	20508	Rock Shaft Stop Dog with 356c, for 23767.....
4822	8941	Wrench for 1547 (Accessories).....
4879	8941	Chain Connecting Link.....

NO.	PLATE	NAME
4882	8941	Treadle Shaft for 126252.....
6335	20508	Rock Shaft Knee Arm for 6336.....
6336	——	Rock Shaft Knee Arm complete for 23767, Nos. 2766, 2767 and 6335....
6337	20508	Rock Shaft Lifting Bracket with two 356c, for 23767.....
6439	——	Chain, 36 in. to 45 in., with 56864 and 56865.....
7071	9925	Feed Eccentric Clamping Washer for 54025 and 68474.....
7125	20508	Rock Shaft Lifting Bracket Hook for 23767.....
8908	8941	Wrench for 1520 (Accessories).....
9525	9925	Thread Unwinder Thread Separator Bracket Arm Clamping Screw Washer for 150060.....
9525	9925	Thread Unwinder Thread Separator Bracket Arm Screw Washer for 150061.....
9842	20504	Machine Base Screw Stud Nut Washer for 131024.....
11173	9920	Presser Bar Guide Bracket Guide.....
12242	20508	Rock Shaft Hanger with two wood screws 1 in. No. 10, for 23767.....
17547	9924	Tension (under thread) Thread Guide..
*23729	——	Feed Eccentric Body for 54025.....
23767	20508	Rock Shaft complete, Nos. 2763, 2770, 6336, 6337, 7125 and two 12242.....
24292	9925	Slack Thread Regulator Holder Shaft Collar with 1019c.....
25303	9923	Presser Bar Ball, size ¼ in., for 64330..
26026	8941	Screw Driver (large) Accessories.....
26276	20511	Presser Foot Hinge Pin for 120353, 131123, 131159, 131162 and 131165..
26485	8941	Screw Driver (small) Accessories.....
27739	20506	Thread Unwinder Thread Cone (wood) for large cones, for 150062.....
27998	20505	Bench Stand Flap Hook and Eye (brass) with wood screw ½ in. No. 5, for 79772.....
29234	20504	Face Plate (upper half) Position Plate..
32572	9924	Tension (upper thread) Releasing Disc.
36030	——	Presser Foot Shank for 131123.....
37563	——	Chain, length 15 in., with 56864 and 56865.....
38210	20501	Thread (under) Nipper Spring (lower) for 147-61 Machine.....

NO.	PLATE	NAME
38211	20501	Thread (under) Nipper Spring (upper) for 147-61 Machine.....
38419	20504	Cloth Plate Slide (right) Spring for 54056, 54058, 68167, 68192 and 131207
38456	9923	Presser Bar Bushing (upper).....
38467	20502	“ “ Spring (flat).....
38468	9925	“ “ “ Stud.....
38481	9925	Thread (under) Take-up Staple Thread Guard for 54435.....
38487	8941	Threading Wire (Accessories).....
41128	9922	Arm Rotary Shaft Bushing (intermediate) Oil Pad (braided cotton) for 68444.....
41538	-----	Bench Stand Flush Bolt with Plate complete for 79772, Nos. 126247, 126248 and four brass wood screws $\frac{5}{8}$ in. No. 4.....
42365	9922	Arm Rock Shaft Oil Pad (braided cotton) for oiling Back Bearing.....
42367	9922	Arm Rotary Shaft Flanged Bushing Oil Pad (braided cotton) for 68446...
42367	9922	Arm Rotary Shaft Front Bearing Oil Pad, lower (braided cotton).....
43503	20504	Looper Throw-out Handle Plunger Spring.....
46009	20501	Thread (upper) Eyelet.....
46041	20501	“ (under) Take-up Staple Spring
46087	-----	Presser Foot Shank for 120353 and 131165.....
46247	20501	Thread (under) Nipper Spring (upper) Stop for 147-61 Machine.....
*49189	-----	Oil Pipe (back of arm) Connection Cap for 68494.....
*49189	-----	Oil Pipe (front of arm) Connection Cap for 131003.....
*49191	-----	Oil Pipe (back of arm) Sleeve for 68492
*49191	-----	“ “ (front of arm) Sleeve for 68498 and 68500.....
50073j	20503	Feed Dog Screw, when movable Needle Guard is used.....
50083c	20503	Arm Rock Shaft Crank (back) Set Screw for 131072.....
50084c	20503	Arm Rotary Shaft Bushing (intermediate) Set Screw (short).....
50150c	9925	Slack Thread Regulator Set Screw for 54042.....

NO.	PLATE	NAME
50326c	9924	Tension (under thread) Screw Stud for 59539.....
50326c	9924	Tension (upper thread) Screw Stud for 59539.....
50396f	20503	Cloth Plate Screw (right).....
50429c	20503	Feed Dog Stop Screw for 68464.....
50473f	20503	Cloth Plate Thread Guard Screw (upper).....
50592c	20504	Presser Bar Lifter Hinge Screw.....
51061c	20503	Feed Eccentric Body Set Screw for 54025 and 68474.....
51119j	20503	Looper Holder Screw.....
51263d	9919	“ Carrier Connection Shaft Sleeve Cap Screw.....
51283c	20503	Balance Wheel Set Screw for 64259....
51570c	9924	Tension (under thread) Regulating Thumb Nut for 59539.....
51570c	9924	Tension (upper thread) Regulating Thumb Nut for 59539.....
51576E	20504	Machine Base Screw Stud Nut for 131024.....
52045	9922	Arm Rock Shaft Bushing (back) Oil Pad (wick) for 68434.....
52045	9922	Arm Rock Shaft Bushing (intermediate) Oil Pad (wick) for 68437.....
52045	9922	Arm Rock Shaft Flanged Bushing (front) Oil Pad (wick).....
53225	9924	Thread (under) Eyelet (back).....
*54018	-----	Crank Connecting Rod Cap (upper) for 68457.....
*54024	-----	Feed Eccentric for 54025.....
54025	20506	Feed Eccentric (adjustable) complete, for 131108, Nos. 217j, 1103c, 7071, 23729, 54024 and two 51061c.....
54027	9919	Looper Carrier with two 175E, for 68482 and 131111.....
54038	9920	Needle Guard (stationary) Holder.....
54039	9920	Presser Bar Guide Bracket with 453c, 640j and 1963.....
54042	9925	Slack Thread Regulator Holder with 175E and two 50150c.....
54044	9920	Slack Thread Regulator Holder Shaft Crank (forked) with 1253c.....
54047	9924	Tension (upper thread) Releasing Shaft Crank with 624c.....
54048	9924	Tension (upper thread) Releasing Shaft Crank Link.....

NO.	PLATE	NAME
54055	20507	Cloth Plate Slide (right) for 54056.....
54056	-----	Cloth Plate Slide (right) complete, for 68450, Nos. 38419, 54055 and two 725j.....
54057	20507	Cloth Plate Slide (right) for 54058.....
54058	-----	Cloth Plate Slide (right) complete, for 131114, Nos. 38419, 54057 and two 725j.....
54067	9920	Needle Guard (stationary) for $\frac{3}{32}$ in. to $\frac{5}{32}$ in. gauges.....
54068	9920	Needle Guard (stationary) for $\frac{3}{16}$ in. to $\frac{3}{8}$ in. gauges.....
54069	9920	Needle Guard (stationary) for $\frac{1}{8}$ in. to $\frac{3}{8}$ in. gauges.....
54070	20506	Tension (upper thread) Bracket.....
54071	20506	“ “ “ Releasing Shaft
54072	20501	Thread (under) Eyelet (front) for 147-61 Machine.....
54094	20501	Thread (upper) Take-up for 54096.....
54095	20501	“ “ “ Plate for 54096
54096	-----	Thread (upper) Take-up complete, Nos. 1449j, 54094, 54095 and 68164.....
54105	9916	Arm Rock Shaft Flanged Bushing (front).....
54120	-----	Presser Foot Shank for 131159 and 131162.....
54218	9922	Arm Rotary Shaft Front Bearing Oil Pad, upper (braided cotton).....
54227	9919	Looper Carrier Connection for 68482 and 131111.....
54228	9919	Looper Carrier Connection Shaft for 68482 and 131111.....
54242	9925	Slack Thread Controller Clamp.....
54435	9925	Thread (under) Take-up Staple with 590e and 38481.....
54450	20501	Arm Rotary Shaft Collar with two 1258c, for 68441 and 131105.....
*54455	-----	Feed Eccentric Body for 68474.....
54477	20504	Machine Base Screw Stud, to fasten base to table, for 131024.....
54648	9922	Arm Oil Cup Oil Pad (braided cotton) for 68350.....
54648	9922	Feed Bar Oil Pad (braided cotton) for 68464.....
54969	9922	Arm Rock Shaft Oil Pad (braided cotton) for oiling Intermediate Bearing.....

NO.	PLATE	NAME
51988	9924	Tension (upper thread) Releasing Pin..
56006	9922	Arm Rotary Shaft Oil Pad (braided cotton) for oiling Intermediate Bearing.....
56864	8941	Chain Hook (large) for 6439 and 37563.
56865	20505	“ “ (small) for 6439 and 37563
57076	9924	Tension (upper thread) Thread Guide (double).....
57234	20502	Feed Rocking Frame Hinge Pin.....
57235	20501	“ “ “ “ “ Bushing
57257	20504	Presser Bar Lifter.....
57285	20506	Machine Cushion (felt) for 131024.....
57974	9922	Arm Rotary Shaft Oil Pad (braided cotton) for oiling Back Bearing.....
59343	9925	Feed Bar Hinge Pin Collar with 735c, for 131196.....
59534	9924	Tension (under thread) Spring.....
59535	9924	“ (upper thread) Spring.....
59537	9924	“ (under thread) Spring Bushing (large).....
59537	9924	Tension (upper thread) Spring Bushing (large).....
59538	9924	Tension (under thread) Spring Bushing (small).....
59538	9924	Tension (upper thread) Spring Bushing (small).....
59539	-----	Tension (under thread) Screw Stud 50326c with 51570c.....
59539	-----	Tension (upper thread) Screw Stud 50326c with 51570c.....
60656	20505	Bench Stand Hinge for 79772.....
61075	9920	Presser Bar Lifting Bracket Connection Connecting Pin.....
64259	20508	Balance Wheel, 2 in. pulley, with two 51283c.....
64315	9925	Looper Driving Shaft and Feed Lifting Eccentric Oil Hole Plug for 68481 and 131110.....
64319	9923	Needle Bar (hollow) for 131045.....
64320	9923	“ “ Bushing (upper).....
64330	20502	Presser Bar with 25303.....
64337	9925	Slack Thread Regulator.....
64356	20501	Thread (under) Take-up Thread Guard Steady Pin.....
68123	9920	Needle Guard (movable) Clamp.....
68164	20501	Thread (upper) Take-up Plate Spring for 54096.....
68166	20507	Cloth Plate Slide (right) for 68167.....

NO.	PLATE	NAME
68167	—	Cloth Plate Slide (right) complete, for 131031, Nos. 38419, 68166 and two 725j.....
68184	20502	Presser Bar Lifting Lever Extension (back).....
68191	20507	Cloth Plate Slide (right) for 68192.....
68192	—	Cloth Plate Slide (right) complete for 131216, Nos. 38419, 68191 and two 725j.....
68222	20509	Belt Guard with two wood screws 1 in. No. 12.....
68261	9924	Tension (upper thread) Releasing Shaft Spring.....
68350	9922	Arm Oil Cup for oiling Arm Rock Shaft Front Bearing.....
68368	9918	Cloth Plate Slide (left) for 131051....
68381	20518	Feed Dog, 17 teeth (14 teeth to the inch) for $\frac{1}{4}$ in. to $\frac{3}{8}$ in. gauges, for making longer stitch than regular, for 131115, for 147-61 Machine.....
*68427	—	Arm, upper and lower (solid) with 948j, 68483 and four 131022.....
68428	9917	Arm Bottom Cover.....
68429	9917	“ “ “ Gasket (cork).....
68430	9922	“ Oil Cup for filling oil reservoir....
68431	9916	“ Rock Shaft for 68432.....
68432	—	“ “ “ 68431 with 1235f and 68439.....
68433	9916	Arm Rock Shaft Bushing (back) for 68434.....
68434	—	Arm Rock Shaft Bushing (back) 68433 with 52045.....
68435	9916	Arm Rock Shaft Bushing (back) Cap...
68436	9916	“ “ “ “ (intermediate) for 68437.....
68437	—	Arm Rock Shaft Bushing (intermediate) 68436 with 52045.....
68439	9916	Arm Rock Shaft Crank (front) with 443c and 853c, for 68432.....
68440	20508	Arm Rotary Shaft for 68441.....
68441	—	“ “ “ 68440 with 640e, 54450, 68459, 68470, 68482 and 131016, for 147-60 Machine.....
68442	20501	Arm Rotary Shaft Bushing (front)...
68443	9917	“ “ “ “ (intermediate) for 68444.....

NO.	PLATE	NAME
68444	—	Arm Rotary Shaft Bushing (intermediate) 68443 with 41128.....
68445	9917	Arm Rotary Shaft Flanged Bushing for 68446.....
68446	—	Arm Rotary Shaft Flanged Bushing 68445 with 42367.....
68447	9917	Arm Side Cover.....
68448	9917	“ “ “ Gasket (cork).....
68449	20508	Cloth Plate for 68450, 131031, 131114, 131208 and 131216.....
68450	—	Cloth Plate complete, to be used with Throat Plates Nos. 131033 and 131172 when $\frac{3}{2}$ in. to $\frac{5}{2}$ in. gauges are required, and Throat Plates Nos. 131017 and 131173 for $\frac{3}{8}$ in. to $\frac{1}{4}$ in. gauges, for 147-60 Machine, Nos. 54056, 68449 and 131051.....
68450	—	Cloth Plate complete, to be used with Throat Plates Nos. 131209 and 131210 when $\frac{3}{2}$ in. to $\frac{5}{2}$ in. gauges are required, and Throat Plates Nos. 131211 and 131212 for $\frac{3}{8}$ in. to $\frac{1}{4}$ in. gauges, for 147-61 Machine, Nos. 54056, 68449 and 131051.....
68452	9916	Crank Connecting Rod (rod only) for 68458.....
*68453	—	Crank Connecting Rod Cap (lower) for 68456.....
*68454	—	Crank Connecting Rod End Bearing (lower) for 68456.....
*68455	—	Crank Connecting Rod End Bearing (upper) for 68457.....
68456	9916	Crank Connecting Rod Head (lower), Nos. 68453, 68454 and two 896e, for 68458.....
68457	9916	Crank Connecting Rod Head (upper) Nos. 54018, 68455 and two 1057e, for 68458.....
68458	9916	Crank Connecting Rod complete, for 68459, Nos. 1722e, 1723e, 68452, 68456 and 68457.....
68459	—	Crank Connecting Rod 68458 with 131072, for 68441 and 131105.....
68460	9918	Face Plate (lower half).....
68461	9918	“ “ “ Gasket (cork)...
68462	9918	“ “ “ (upper half).....
68463	9918	Feed Bar for 68464.....

NO.	PLATE	NAME
68464	9918	Feed Bar complete for 131196, Nos. 50429c, 54648, 68463, 68467 and two 207E.....
68467	9918	Feed Bar Wearing Plate for 68464.....
68468	9918	" Connecting Rod with 1057E, 68469, 131090, 134260 and two 896E, for 68470.....
*68469	-----	Feed Connecting Rod Cap for 68468....
68470	-----	" " " 68468 with 68474, for 68441.....
68471	9918	Feed Connecting Rod Cover for 147-60 Machine.....
68472	20511	Feed Dog, 16 teeth (16 teeth to the inch) for $\frac{3}{16}$ in. to $\frac{5}{16}$ in. gauges, with row of teeth between the needles, for 131017 and 131173, for 147-60 Machine.....
68472	20511	Feed Dog, 16 teeth (16 teeth to the inch) for $\frac{3}{16}$ in. to $\frac{5}{16}$ in. gauges, with row of teeth between the needles, for 131211 and 131212, for 147-61 Machine.....
*68473	-----	Feed Eccentric for 68474.....
68474	9918	Feed Eccentric (adjustable) complete, for 68470, Nos. 217J, 1103c, 7071, 54455, 68473 and two 51061c.....
68476	9919	Looper (back) closed eye, for lap seam felling.....
68477	9919	Looper (front) closed eye, for lap seam felling.....
68478	9919	Looper Carrier Connection Shaft Sleeve (eccentric).....
68479	9919	Looper Carrier Driver with 68480 and four 175E, for 68482 and 131111.....
*68480	-----	Looper Carrier Driver Cap for 68479
68481	20502	" Driving Shaft and Feed Lifting Eccentric with two 64315, for 68482..
68482	-----	Looper Driving Shaft and Feed Lifting Eccentric 68481 with 54027, 54227, 54228 and 68479, for 68441.....
*68483	-----	Looper Driving Shaft and Feed Lifting Eccentric Bracket with 761E, for 68427
68484	20502	Looper Driving Shaft and Feed Lifting Eccentric Bushing.....
68485	20502	Looper Throw-out Handle with two 443c.....
68486	20502	Looper Throw-out Handle Plunger.....

NO.	PLATE	NAME
68487	9923	Needle Bar Bushing (lower).....
68488	9923	" " Connecting Link and Thread (upper) Controller for 131047.....
68489	9923	Needle Bar Connecting Link Hinge Stud (hollow) for 68490.....
68490	-----	Needle Bar Connecting Link Hinge Stud 68489 with 861c and 130007, for 131047.....
68491	9923	Needle Bar Connecting Stud with 211F and two 187E, for 131047.....
68492	9921	Oil Pipe (back of arm) with 49191 and 68497, for oiling Feed Rocking Frame Hinge Pin Front Bearing.....
68493	9921	Oil Pipe (back of arm) Clamp.....
68494	9921	" " " " Connection with 49189, 68495 and two 198E, for oiling Feed Rocking Frame Hinge Pin Back Bearing.....
68495	9922	Feed Bar Slide Block Oil Pad (wick) for 134259.....
68495	9922	Oil Pipe (back of arm) Connection Oil Pad (wick) for 68494.....
68496	9921	Oil Pipe (back of arm) Coupling.....
68497	9922	Looper Driving Shaft and Feed Lifting Eccentric Front Bearing Oil Pad (wick).....
68497	9922	Oil Pipe (back of arm) Oil Pad (wick) for 68492, 131001 and 131112.....
68497	9922	Oil Pipe (front of arm) Oil Pad (wick) for 131001, 131112 and 131113.....
68498	9921	Oil Pipe (front of arm) with 131089 and two each 1733 and 49191, for oiling Looper Driving Shaft and Feed Lifting Eccentric Front Bearing.....
68500	9921	Oil Pipe (front of arm) with 1733, 49191, 131084 and 131089 for oiling Arm Rotary Shaft Front Bearing.....
79772	-----	Bench Stand with 27998, two each 41538, 124500, three wood screws $1\frac{1}{4}$ in. No. 14 and four each 60656 and wood screws $\frac{5}{8}$ in. No. 7.....
120341	8941	Tweezers (curved) Accessories.....
120344	8941	Oiler (copper plated) with 120345 (Accessories).....
120345	8941	Oiler Spout, 5 in. long, for 120344.....
120352	-----	Presser Foot Plate for 120353.....

NO.	PLATE	NAME
120353	20510	Presser Foot (hinged) complete, for $\frac{3}{32}$ in. to $\frac{5}{32}$ in. gauges, for lap seam felling, for 147-60 Machine, Nos. 26276, 46087 and 120352.....
120353	20510	Presser Foot (hinged) complete, to be used with Feed Dog No. 131032 when $\frac{3}{32}$ in. to $\frac{5}{32}$ in. gauges are required, and Feed Dog No. 68381 for $\frac{1}{4}$ in. to $\frac{3}{8}$ in. gauges, for lap seam felling, for 147-61 Machine, Nos. 26276, 46087 and 120352.....
120848	20519	Lap Seam Feller on Shank, for medium heavy and heavy weight material, for 147-61 Machine.....
120906	20519	Lap Seam Feller on Shank, for sleeving, for light or medium weight material, for 147-60 Machine.....
124500	20505	Bench Stand Flap Hinge for 79772.....
126247	20505	" " Flush Bolt for 41538.....
126248	20505	" " " " Plate for 41538.....
126249	20509	Treadle for 126252.....
126250	8941	" Spring for 126252.....
126251	20509	" Stand for 126252.....
126252	20509	Treadle complete, Nos. 4882, 126249 to 126251 and two wood screws 1 in. No. 16
128419	9922	Looper Carrier Connection Shaft Oil Pad (braided cotton).....
130007	9923	Needle Bar Connecting Link Hinge Stud Oil Pad (wick) for 68490.....
131001	9921	Oil Pipe (front of arm) with 68497 and 131003, for oiling Feed Connecting Rod, for 147-60 Machine.....
131002	9921	Oil Pipe (front of arm) Connection with 131049 and two 198e, for oiling Looper Throw-out Device.....
131003	9921	Oil Pipe (front of arm) Connection with 49189 and two 198e, for 131001, 131112 and 131113.....
131004	9921	Oil Pipe (front of arm) Coupling (center).....
131004	9921	Oil Pipe (front of arm) Coupling (left) ..
131006	9923	Presser Bar Bushing (lower).....
131007	9920	" " Lifting Bracket with 462c..
131008	9920	" " " " Connection
131009	20502	" " " Lever.....
131010	20502	" " " " Extension (front).....

NO.	PLATE	NAME
131011	9924	Tension (upper thread) Releasing Shaft Spring Position Plate.....
131012	20502	Tension (under thread) Bracket.....
131013	9925	Thread (under) Eyelet (front) for 147-60 Machine.....
131014	9925	Thread (under) Take-up with two 465c
131016	20501	" " " Thread Guard (brass) for 68441.....
131017	20511	Throat Plate, for $\frac{1}{16}$ in. to $\frac{5}{16}$ in. gauges, for 68472, for lap seam felling, for 147-60 Machine.....
131018	20509	Machine Base for 131024.....
131019	20505	" " Oil Pipe for 131024.....
131020	20505	" " " " Valve for 131024
131022	20504	" " Screw Stud Bushing (rubber) for 68427.....
131024	-----	Machine Base complete, Nos. 131018 to 131020, three each 9842, 51576E, 54477 and four each 57285 and 131205
131025	9925	Slack Thread Controller.....
131028	9925	Looper Driving Shaft and Feed Lifting Eccentric Bushing Oil Plug.....
131031	-----	Cloth Plate complete, to be used with Throat Plates Nos. 131017 and 131173 when $\frac{3}{32}$ in. and $\frac{5}{16}$ in. gauges are required, for 147-60 Machine, Nos. 68167, 68449 and 131051.....
131031	-----	Cloth Plate complete, to be used with Throat Plates Nos. 131211 and 131212 when $\frac{3}{32}$ in. and $\frac{5}{16}$ in. gauges are required, for 147-61 Machine, Nos. 68167, 68449 and 131051.....
131032	20510	Feed Dog, 17 teeth (16 teeth to the inch) for $\frac{3}{32}$ in. to $\frac{5}{32}$ in. gauges, for 131033 and 131172, for 147-60 Machine.....
131032	20510	Feed Dog, 17 teeth (16 teeth to the inch) for $\frac{3}{32}$ in. to $\frac{5}{32}$ in. gauges, for 131209 and 131210, for 147-61 Machine.....
131033	20510	Throat Plate, for $\frac{3}{32}$ in. to $\frac{3}{8}$ in. gauges, for 131032, for lap seam felling, for 147-60 Machine.....
131042	9925	Slack Thread Regulator Holder Shaft..
131044	9923	Needle Clamp with two 1498f, for $\frac{3}{32}$ in. to $\frac{1}{2}$ in. gauges, for 131045.....
131045	-----	Needle Bar complete, for $\frac{3}{32}$ in. to $\frac{1}{2}$ in. gauges, Nos. 64319 and 131044.....

NO.	PLATE	NAME
131047	—	Needle Bar Connecting Link and Thread (upper) Controller 68488 with 68490 and 68491.....
*131049	—	Oil Pipe (front of arm) Connection Cap for 131002.....
131050	9918	Cloth Plate Slide (left) Spring for 131051.....
131051	—	Cloth Plate Slide (left) complete for 68450, 131031, 131114, 131208 and 131216, Nos. 68368, 131050 and two 725J.....
131052	9919	Looper Holder with 452c and 1120c....
131056	20504	Arm Rock Shaft Adjusting Screw Washer.....
131072	9916	Arm Rock Shaft Crank, back (ball bearing, solid) with two 50083c, for 68459.
131084	9921	Oil Pipe (front of arm) Connection with 131085 and two 198e, for 68500.....
*131085	—	Oil Pipe (front of arm) Connection Cap for 131084.....
*131086	—	Oil Pipe (front of arm) Coupling (right) for 131087.....
131087	9921	Oil Pipe (front of arm) Coupling (right) 131086 with 131088.....
*131088	—	Oil Pipe (front of arm) Coupling (right) Oil Lead for 131087.....
131089	9922	Oil Pipe (front of arm) Oil Pad (wick) for 68498 and 68500.....
131090	9922	Feed Connecting Rod Oil Pad (wick) for 68468 and 131106.....
131093	20512	Feed Dog, 16 teeth (16 teeth to the inch) for $\frac{1}{2}$ in. and $\frac{3}{8}$ in. gauges, for 131094 and 131149, for 147-60 Machine.....
131093	20512	Feed Dog, 16 teeth (16 teeth to the inch) for $\frac{1}{2}$ in. and $\frac{3}{8}$ in. gauges, for 131213 and 131214, for 147-61 Machine.....
131094	20512	Throat Plate, for $\frac{1}{2}$ in. and $\frac{3}{8}$ in. gauges, for 131093, for plain stitching, for 147-60 Machine.....
131095	9916	Arm Rock Shaft Bushing (back) Cap Washer (fibre).....
131096	20501	Thread (under) Take-up Stripper.....
131104	20508	Arm Rotary Shaft for 131105.....

NO.	PLATE	NAME
131105	—	Arm Rotary Shaft 131104 with 640E, 54450, 68459, 131108, 131111, 131184 and 131194, for 147-61 Machine.....
131106	20506	Feed Connecting Rod with 1057E, 131090, 131107, 134260 and two 896E, for 131108.....
*131107	—	Feed Connecting Rod Cap for 131106..
131108	—	" " " 131106with54025 for 131105.....
131110	20506	Looper Driving Shaft and Feed Lifting Eccentric with two 64315 for 131111
131111	—	Looper Driving Shaft and Feed Lifting Eccentric 131110 with 54027, 54227, 54228 and 68479, for 131105.....
131112	9921	Oil Pipe (front of arm) with 68497 and 131003, for oiling Feed Bar Slide Block.....
131113	9921	Oil Pipe (front of arm) with 68497 and 131003, for oiling Feed Connecting Rod, for 147-61 Machine.....
131114	—	Cloth Plate complete, to be used with Throat Plates Nos. 131094 and 131149 when $\frac{1}{2}$ in. and $\frac{3}{8}$ in. gauges are required, for 147-60 Machine, Nos. 54058, 68449 and 131051.....
131114	—	Cloth Plate complete, to be used with Throat Plates Nos. 131213 and 131214 when $\frac{1}{2}$ in. and $\frac{3}{8}$ in. gauges, are required, for 147-61 Machine, Nos. 54058, 68449 and 131051.....
131115	20518	Throat Plate, for $\frac{1}{4}$ in. to $\frac{3}{8}$ in. gauges, for 68381, for lap seam felling, for making longer stitch than regular, for 147-61 Machine.....
131118	20517	Feed Dog, 16 teeth (14 teeth to the inch) for $\frac{1}{2}$ in. to $\frac{3}{8}$ in. gauges, for 131124 and 131215, for 147-61 Machine.....
131121	9920	Needle Guard (movable) for $\frac{1}{2}$ in. to $\frac{1}{2}$ in. gauges.....
131122	—	Presser Foot Plate for 131123.....
131123	20517	Presser Foot (hinged) complete, for $\frac{1}{2}$ in. to $\frac{1}{2}$ in. gauges, for plain stitching, for 147-61 Machine, Nos. 26276, 36030 and 131122.....

NO.	PLATE	NAME
131124	20517	Throat Plate, for $\frac{1}{4}$ in. to $\frac{1}{2}$ in. gauges, for 131118, for lap seam felling, for 147-61 Machine.....
131130	20508	Cloth Plate Thread Guard.....
131131	9919	Looper (back) closed eye, for general work.....
131132	9919	Looper (front) closed eye, for general work.....
131149	20512	Throat Plate, for $\frac{1}{4}$ in. and $\frac{3}{8}$ in. gauges, for 131093, for lap seam felling, for 147-60 Machine.....
131157	20506	Thread (under) Take-up Staple Bracket with 460c.....
131158	—	Presser Foot Plate for 131159.....
131159	20511	Presser Foot (hinged) complete, for $\frac{3}{8}$ in. to $\frac{3}{4}$ in. gauges, for lap seam felling, Nos. 26276, 54120 and 131158
131160	20513	Feed Dog, 16 teeth (16 teeth to the inch) for $\frac{3}{8}$ in. to $\frac{1}{2}$ in. gauges, for 131163 and 131166, for 147-60 Machine.....
131161	—	Presser Foot Plate for 131162.....
131162	20513	Presser Foot (hinged) complete, for $\frac{3}{8}$ in. to $\frac{1}{2}$ in. gauges, for lap seam felling, Nos. 26276, 54120 and 131161
131163	20513	Throat Plate, for $\frac{3}{8}$ in. to $\frac{1}{2}$ in. gauges, for 131160, for lap seam felling, for 147-60 Machine.....
131164	—	Presser Foot Plate for 131165.....
131165	20510	Presser Foot (hinged) complete, for $\frac{3}{8}$ in. to $\frac{1}{2}$ in. gauges, for plain stitching, for 147-60 Machine, Nos. 26276, 46087 and 131164.....
131165	20510	Presser Foot (hinged) complete for $\frac{3}{8}$ in. to $\frac{3}{4}$ in. gauges, for plain stitching, for 147-61 Machine, Nos. 26276, 46087 and 131164.....
131166	20513	Throat Plate, for $\frac{3}{8}$ in. to $\frac{1}{2}$ in. gauges, for 131160, for plain stitching, for 147-60 Machine.....
131172	20510	Throat Plate, for $\frac{3}{8}$ in. to $\frac{5}{8}$ in. gauges, for 131032, for plain stitching, for 147-60 Machine.....
131173	20511	Throat Plate, for $\frac{3}{16}$ in. to $\frac{5}{16}$ in. gauges, for 68472, for plain stitching, for 147-60 Machine.....

NO.	PLATE	NAME
131174	9920	Needle Guard (movable) for $\frac{3}{8}$ in. gauge
131175	9920	“ “ (stationary) for $\frac{3}{8}$ in. to $\frac{1}{2}$ in. gauges.....
131184	20501	Thread (under) Nipper Cam with 465c, for 131105.....
131194	20501	Thread (under) Take-up Thread Guard (brass) for 131105.....
131195	20502	Feed Rocking Frame with two 453c, for 131196.....
131196	—	Feed Rocking Frame 131195 with 59343, 68464 and 131197.....
131197	9918	Feed Bar Hinge Pin (eccentric) for 131196.....
131205	20504	Machine Base Screw Stud, to position machine on base, for 131024.....
131206	20507	Cloth Plate Slide (right) for 131207....
131207	—	Cloth Plate Slide (right) complete for 131208, Nos. 38419, 131206 and two 725j.....
131208	—	Cloth Plate complete, to be used with Throat Plates Nos. 131163 and 131166 when $\frac{1}{4}$ in. to $\frac{1}{2}$ in. gauges are required, for 147-60 Machine, Nos. 68449, 131051 and 131207.....
131208	—	Cloth Plate complete, to be used with Throat Plate No. 131115 when $\frac{1}{4}$ in. to $\frac{1}{8}$ in. gauges are required, and Throat Plates Nos. 131124 and 131215 for $\frac{1}{4}$ in. to $\frac{1}{2}$ in. gauges, for 147-61 Machine, Nos. 68449, 131051 and 131207.....
131209	20514	Throat Plate, for $\frac{3}{8}$ in. to $\frac{5}{8}$ in. gauges, for 131032, for lap seam felling, for 147-61 Machine.....
131210	20514	Throat Plate, for $\frac{3}{8}$ in. to $\frac{5}{8}$ in. gauges, for 131032, for plain stitching, for 147-61 Machine.....
131211	20515	Throat Plate, for $\frac{3}{16}$ in. to $\frac{5}{16}$ in. gauges, for 68472, for lap seam felling, for 147-61 Machine.....
131212	20515	Throat Plate, for $\frac{3}{16}$ in. to $\frac{5}{16}$ in. gauges, for 68472, for plain stitching, for 147-61 Machine.....
131213	20516	Throat Plate, for $\frac{1}{4}$ in. and $\frac{3}{8}$ in. gauges, for 131093, for lap seam felling, for 147-61 Machine.....

NO.	PLATE	NAME
131214	20516	Throat Plate, for $\frac{1}{2}$ in. and $\frac{3}{8}$ in. gauges, for 131093, for plain stitching, for 147-61 Machine.....
131215	20517	Throat Plate, for $\frac{1}{2}$ in. to $\frac{1}{4}$ in. gauges, for 131118, for plain stitching, for 147-61 Machine.....
131216	-----	Cloth Plate complete, to be used with Throat Plate No. 131115 when $\frac{1}{2}$ in. and $\frac{3}{8}$ in. gauges, are required, for 147-61 Machine, Nos. 68192, 68449 and 131051.....
134258	9918	Feed Bar Slide Block for 134259.....
134259	9918	" " " " 134258 with 68495 and 134260.....
134260	9922	Feed Bar Slide Block Oil Pad Retainer for 134259.....
134260	9922	Feed Connecting Rod Oil Pad Retainer for 68468 and 131106.....
*150057	-----	Thread Unwinder Thread Separator for 150058.....
150058	9505	Thread Unwinder Thread Separator 150057 with 150059, for 150061.....
*150059	-----	Thread Unwinder Thread Separator Bracket for 150058.....
150060	9505	Thread Unwinder Thread Separator Bracket Arm with 164J and 9525, for 150061.....
150061	-----	Thread Unwinder Thread Separator complete for 150062, Nos. 164J, 9525, 150058 and 150060.....
150062	9505	Thread Unwinder complete, for four spools, Nos. 150061, 201696J, 202490, 225324, 225326, 225388, two 225395, three wood screws $\frac{1}{8}$ in. No. 12 and four each 150203 and 225391.....
150203	20509	Thread Unwinder Spool Rest Cushion for 150062.....
200383c	9925	Thread Unwinder Spool Rest Rod Set Screw for 202490.....
201018c	20504	Thread Unwinder Spool Rest Set Screw, for 225395.....
201696J	20504	Thread Unwinder Thread Guide Lock Nut for 150062.....
202490	9505	Thread Unwinder Spool Stand with 200383c, for 150062.....
225322	20504	Thread Unwinder Thread Guide Rod Washer for 225324.....

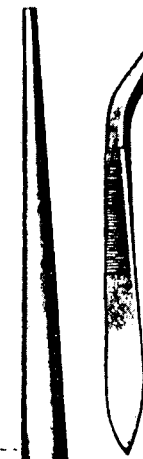
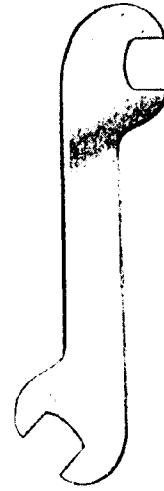
NO.	PLATE	NAME
225324	9505	Thread Unwinder Thread Guide Rod with 208E and 225322, for 150062....
225326	20504	Thread Unwinder Thread Guide Position Cup for 150062.....
225388	9505	Thread Unwinder Spool Rest Rod for 150062.....
225390	20506	Thread Unwinder Thread Cone Holder, for inverted cones, for 150062.....
225391	9505	Thread Unwinder Thread Guide for 150062.....
225395	9505	Thread Unwinder Spool Rest (for two spools) with 201018c, for 150062.....

SINGER Needles should be used
in **SINGER** Machines
These Needles and their Containers
are marked with the
Company's Trade Mark "**SIMANCO.****" 1

Needles in Containers marked
"**FOR SINGER MACHINES**"
are **NOT SINGER** made needles. 2

PLATE 8941—ONE-HALF SIZE

19221 8908 120344 120341 38487



120345-----

4822



26026



121108



4879



56864



126250



4882



PLATE 9505—ONE-SIXTH SIZE

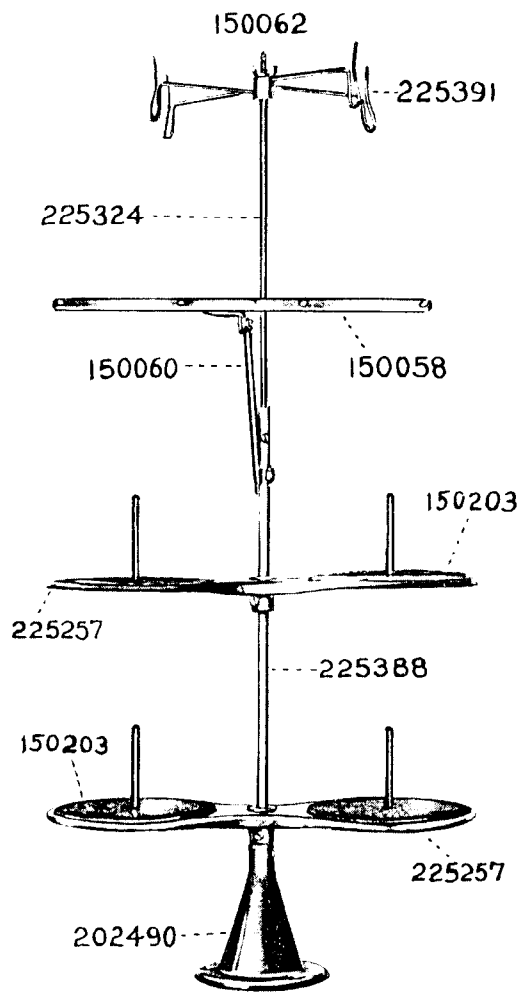


PLATE 9916—ONE-HALF SIZE

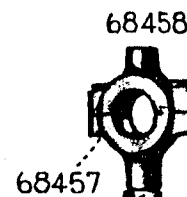


PLATE 9917—ONE-HALF SIZE

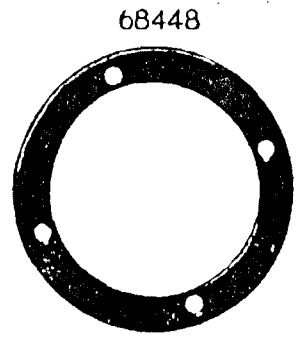
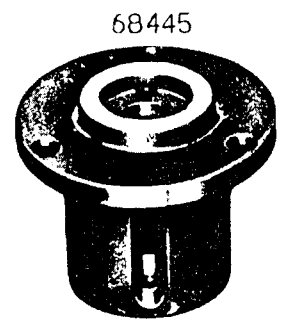
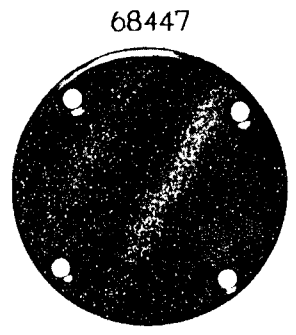
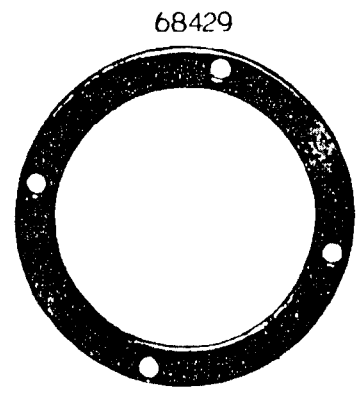
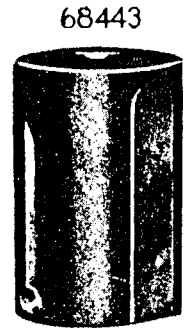
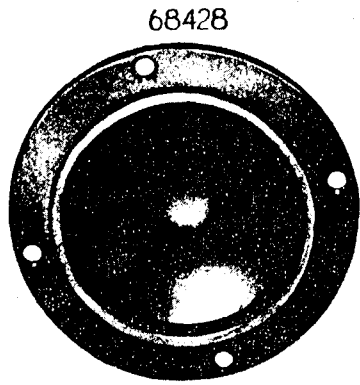
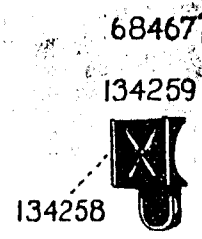
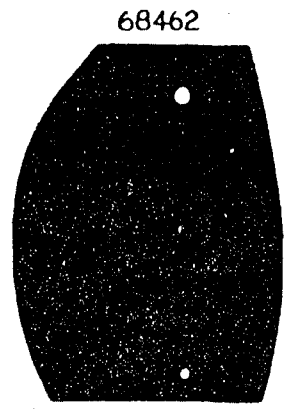
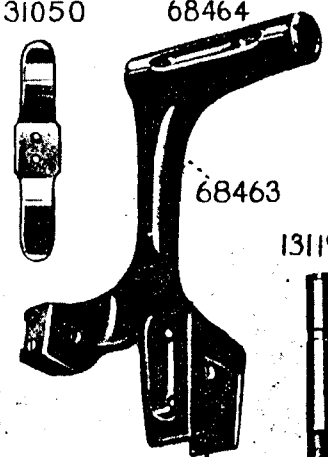
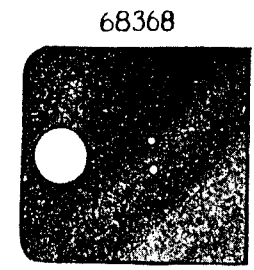


PLATE 9918—ONE-HALF SIZE



134259

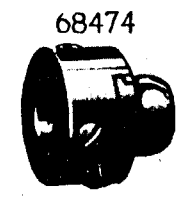
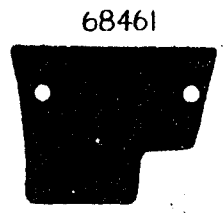
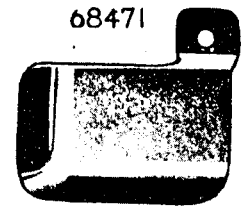
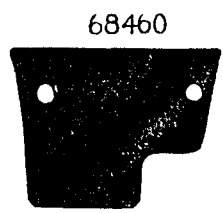
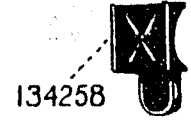


PLATE 9919—FULL SIZE

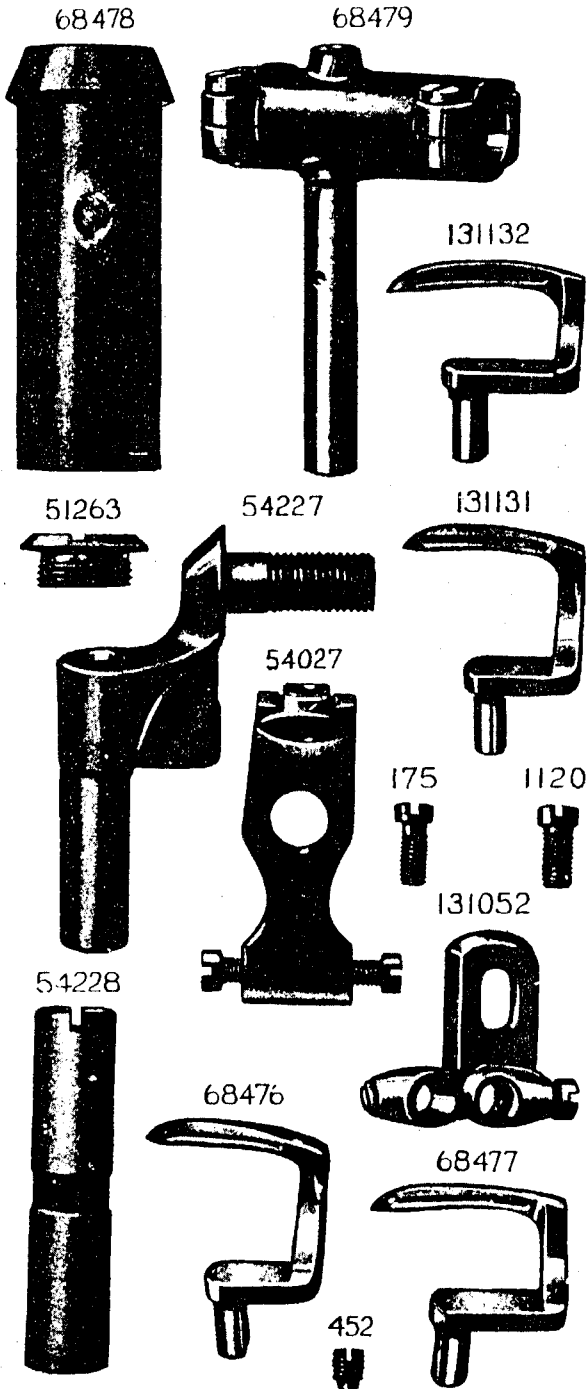


PLATE 9920—FULL SIZE

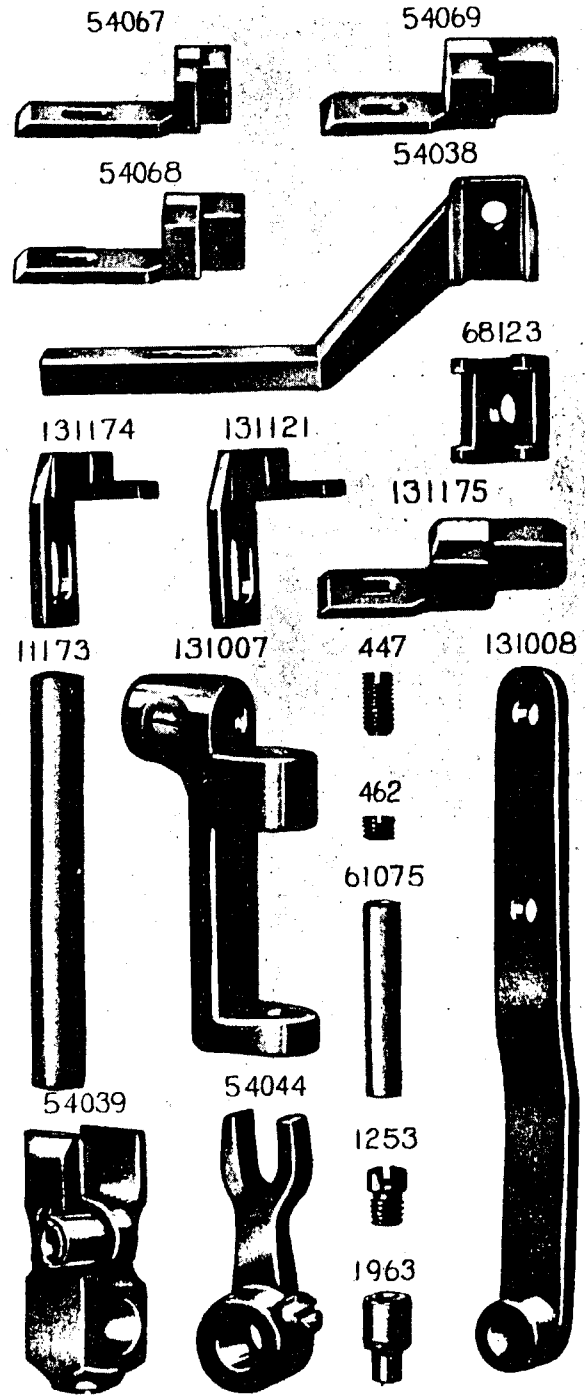


PLATE 9921—ONE-HALF SIZE

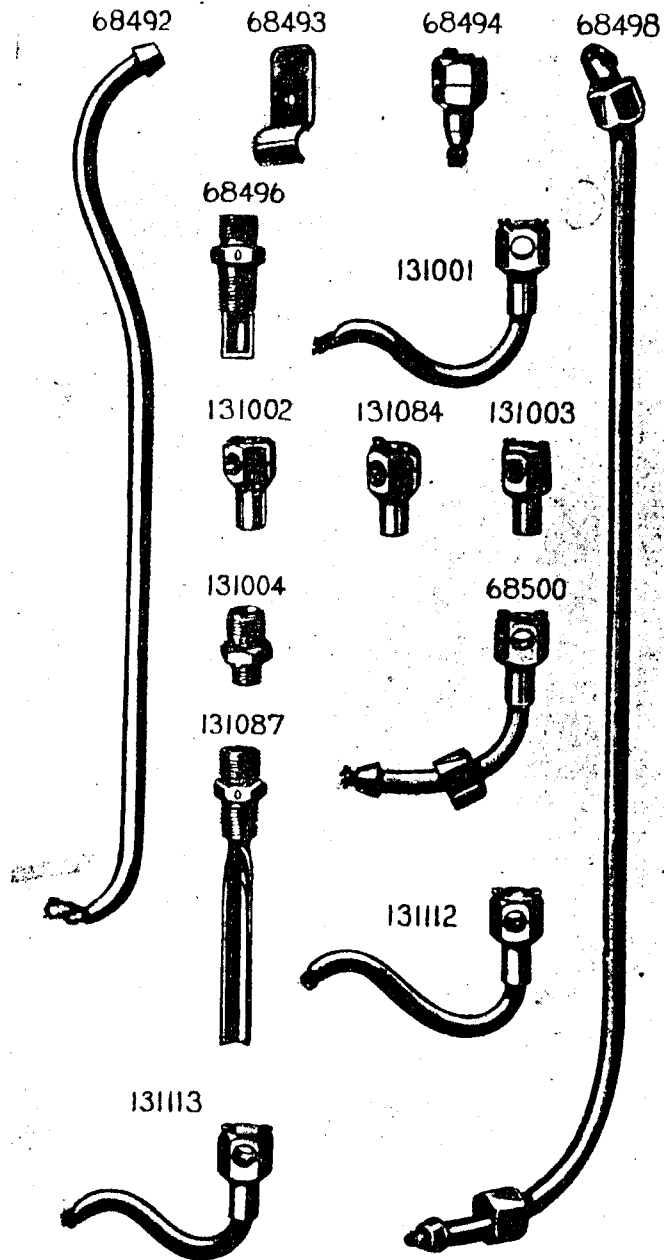


PLATE 9922—FULL SIZE

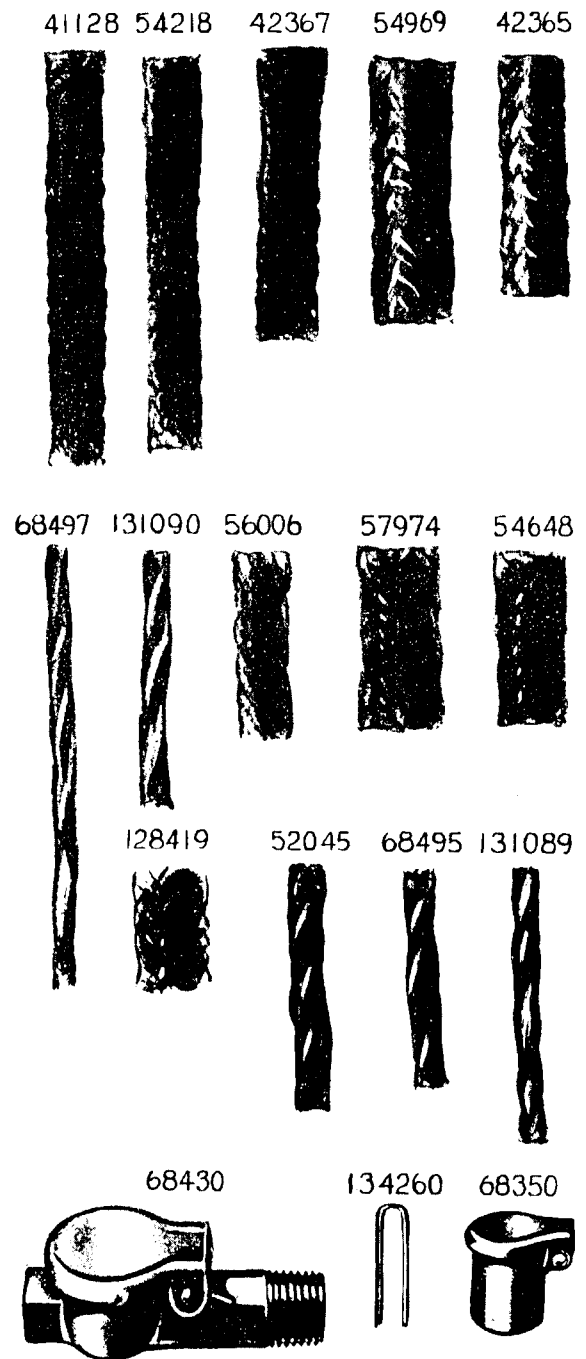


PLATE 9923—FULL SIZE

64319



131044



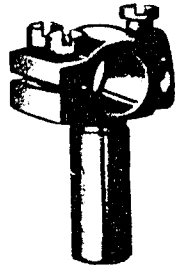
64320



68488



68491



68487



130007



1520



211



187



1133



853



1498



861



68489



25303



38456

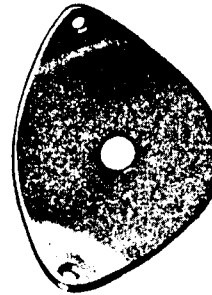


131006

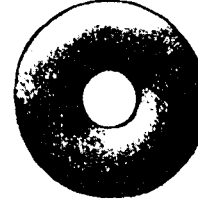


PLATE 9924—FULL SIZE

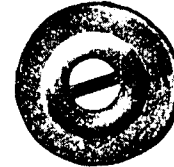
57076



2102



32572



53225



624



50326



51570



54988



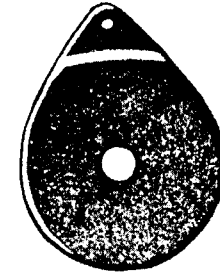
691



54048



17547



59534



59538



59535



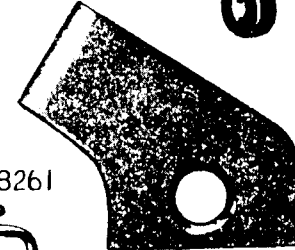
59537



376



131011



68261

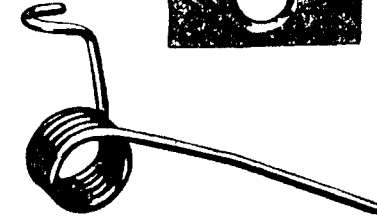


PLATE 9925—FULL SIZE

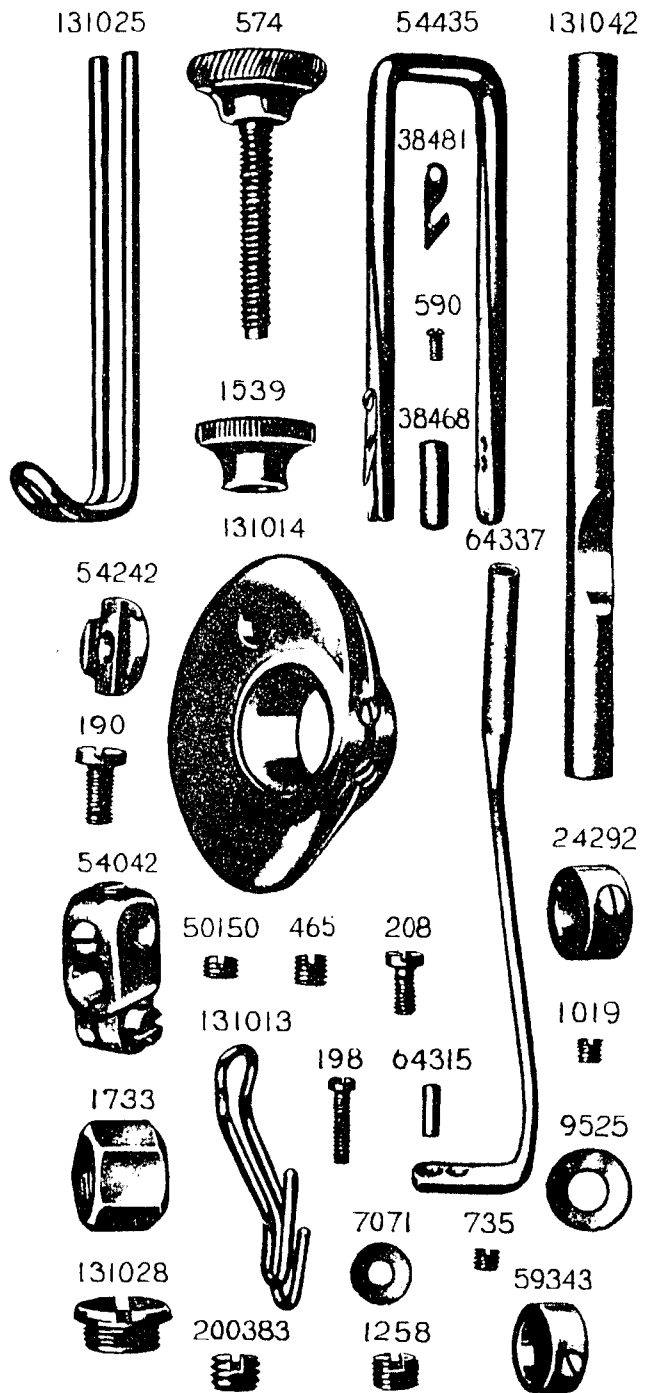


PLATE 20501—FULL SIZE

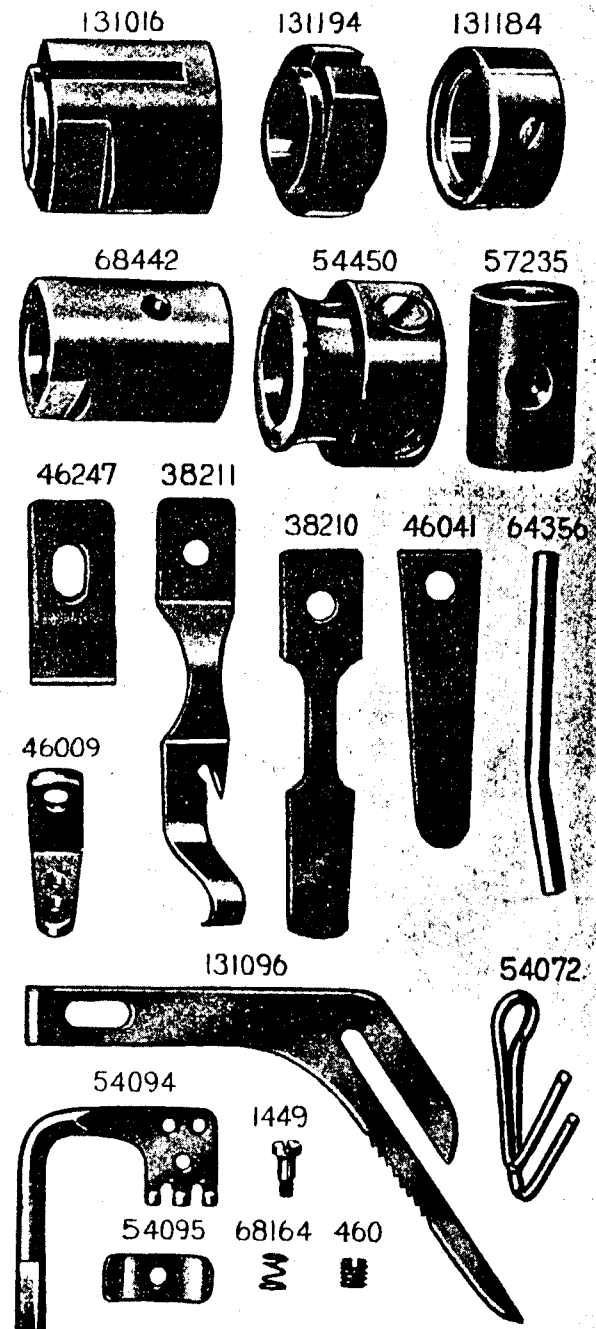


PLATE 20502—ONE-HALF SIZE

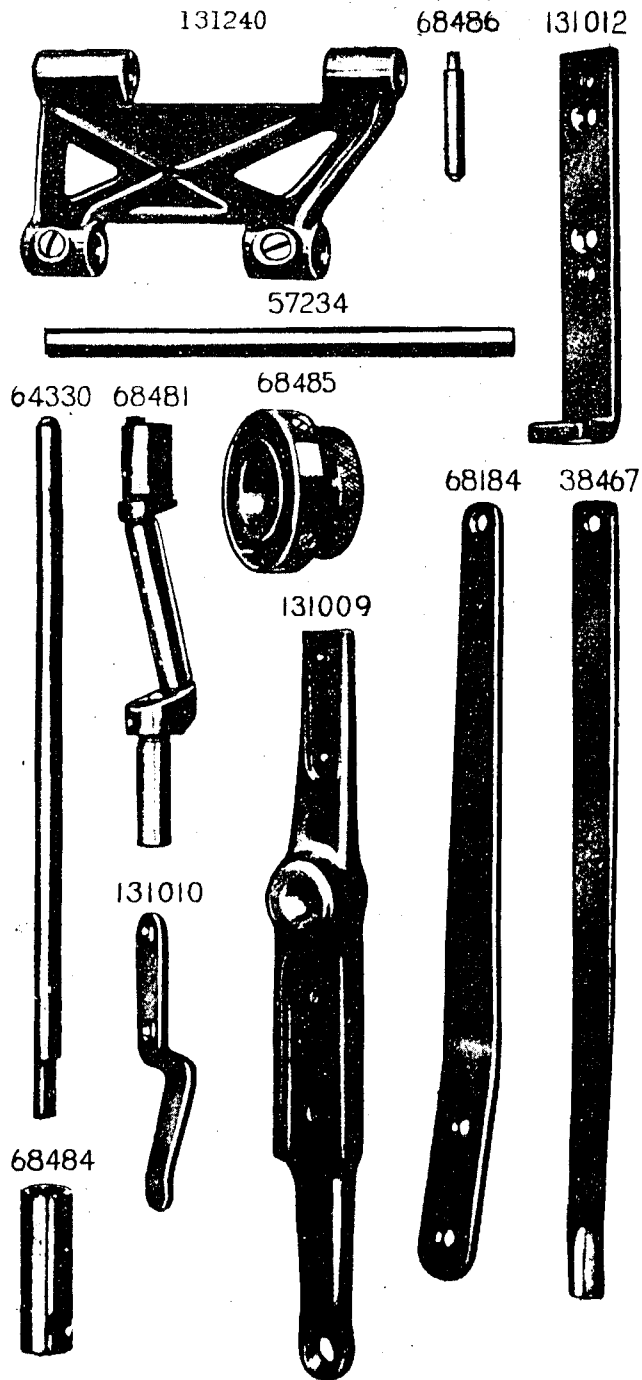


PLATE 20503—FULL SIZE

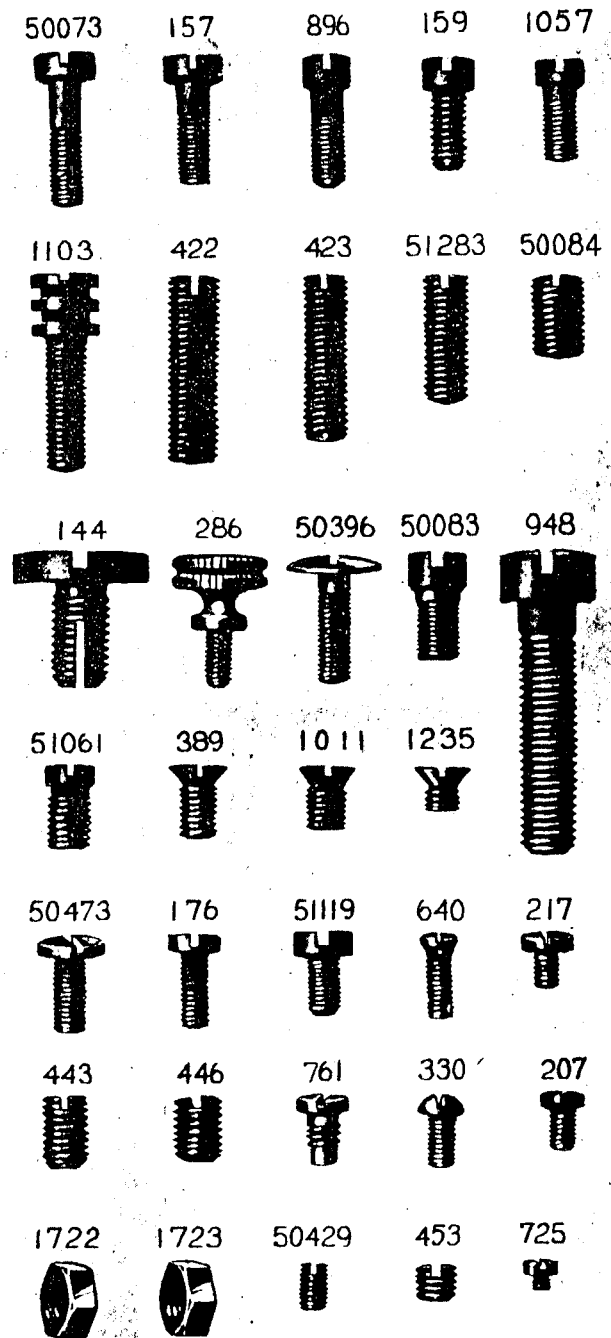


PLATE 20504—FULL SIZE

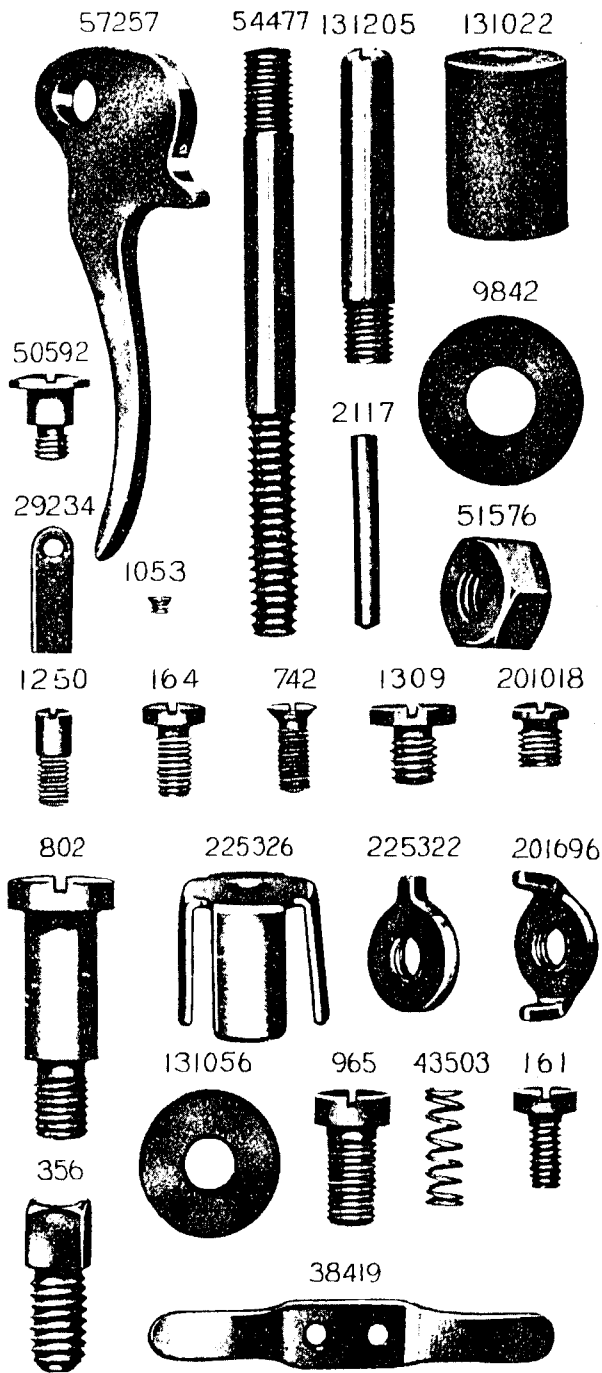


PLATE 20505—FULL SIZE

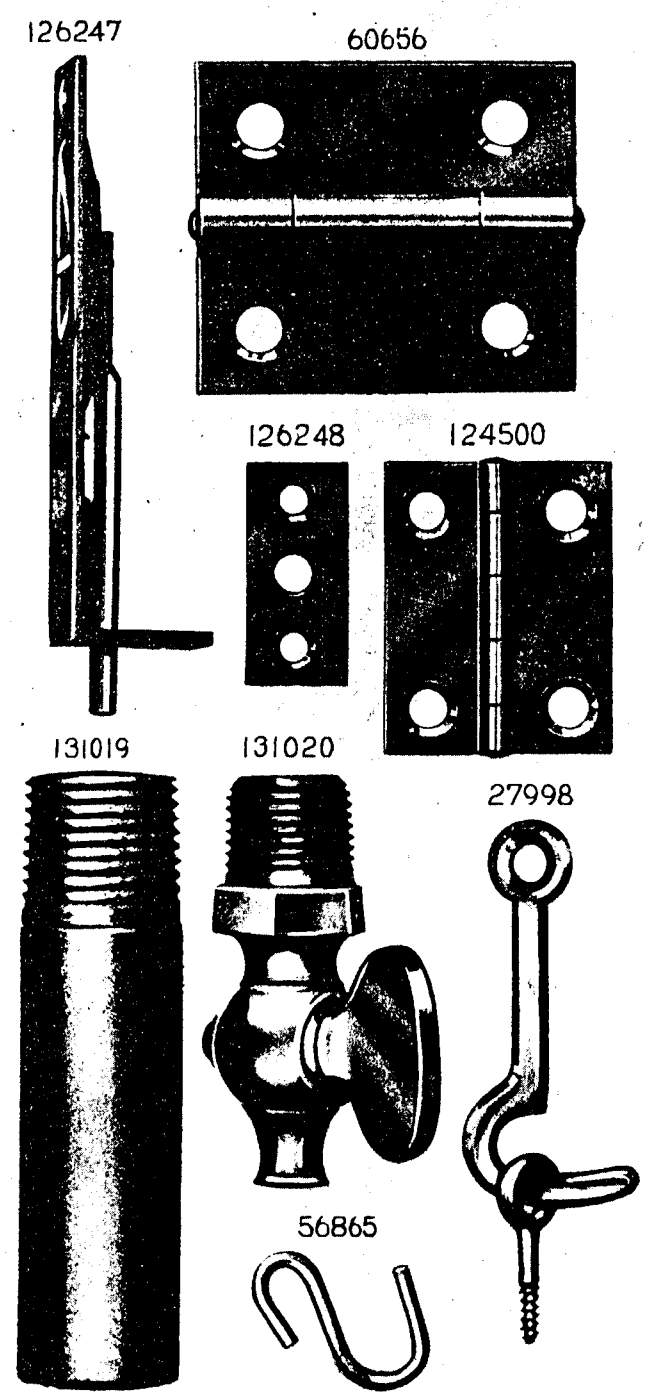
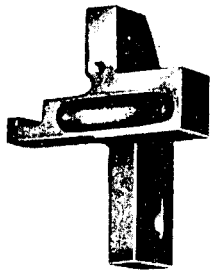


PLATE 20506—ONE-HALF SIZE

131157



54071



54070



54025



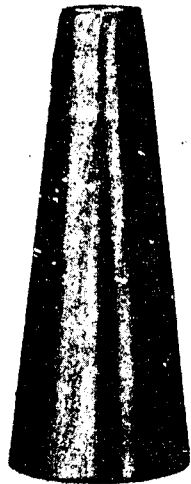
131106



57285



27739



131110



225390

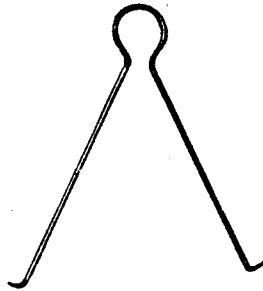
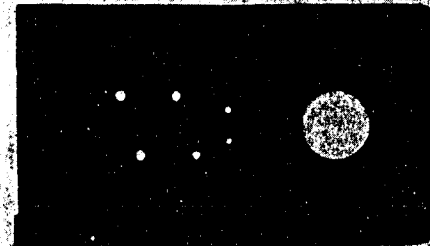
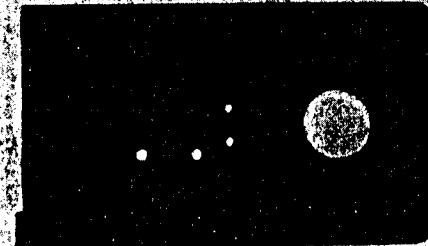


PLATE 20507—ONE-HALF SIZE

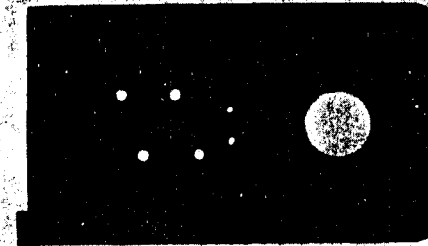
54055



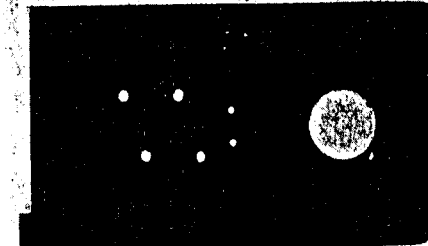
68166



54057



131206



68191

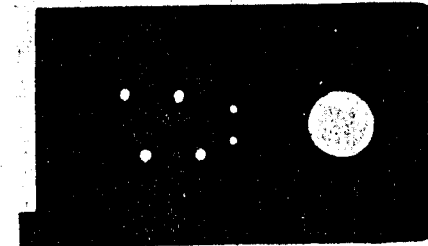
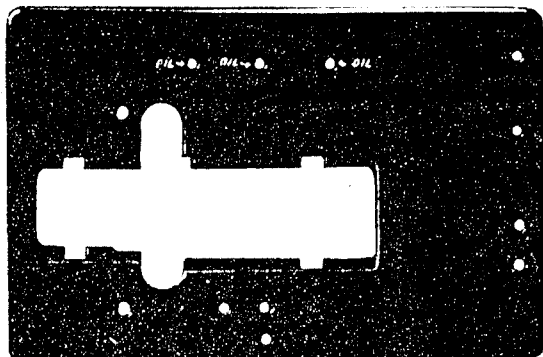
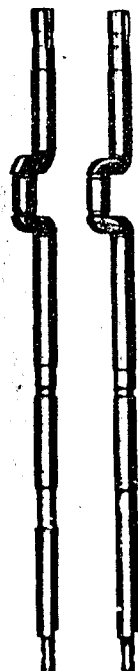


PLATE 20508—ONE-FOURTH SIZE

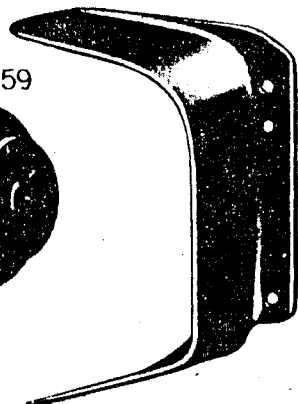
68449



68440 131104



131130



64259

--7125

23767



6337

2763

2766

2770

6335

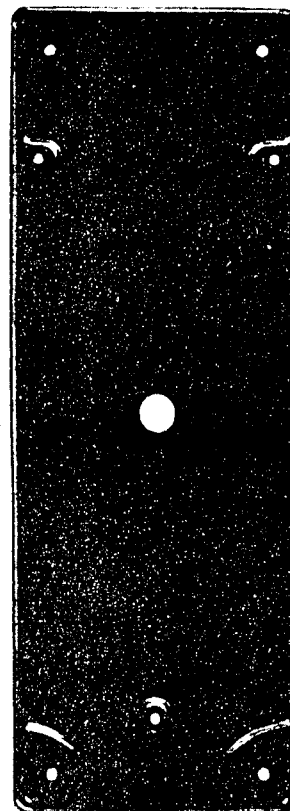
12242

2767

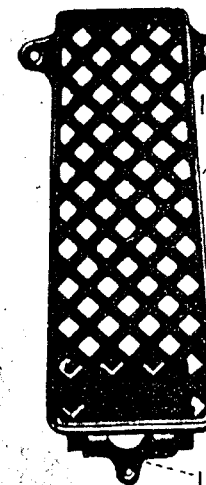


PLATE 20509—ONE-FOURTH SIZE

131018



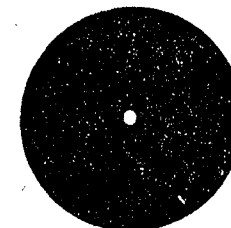
126252



126249

126251

150203



68222

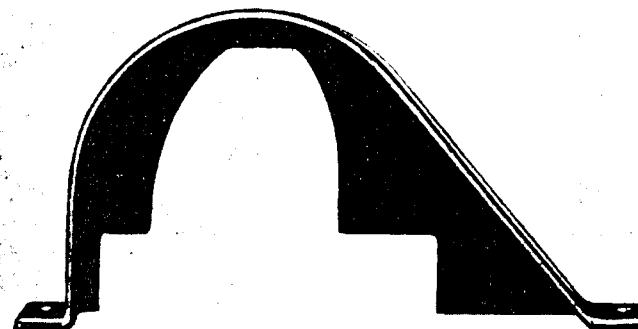


PLATE 20510—FULL SIZE

131033



131032



120353



131172



131165

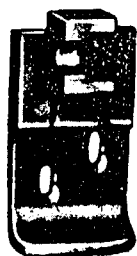


PLATE 20511—FULL SIZE

131017



68472



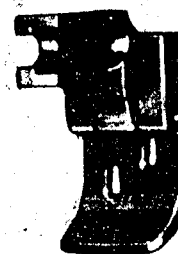
131159



131173



131165



26276



PLATE 20512-FULL SIZE

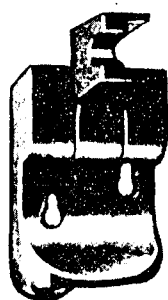
131149



131093



131159



131094



131165

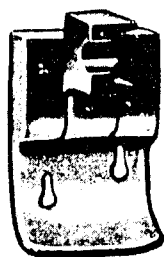


PLATE 20513-FULL SIZE

131163



131160



131162



131166



131165

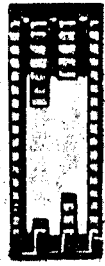


PLATE 20514-FULL SIZE

131209



131032



120353



131210



131165



PLATE 20515-FULL SIZE

131211



68472



131159



131212



131165

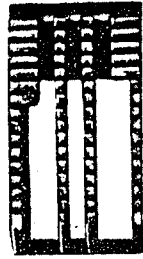


PLATE 20516—FULL SIZE

131213



131093



131159



131214



131165

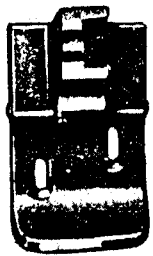
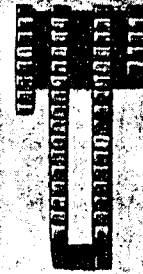


PLATE 20517—FULL SIZE

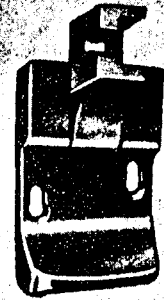
131124



131118



131162



131215



131123

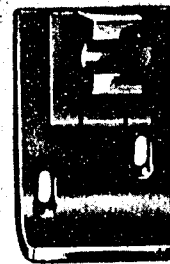


PLATE 20518--FULL SIZE

13115



68381



120353

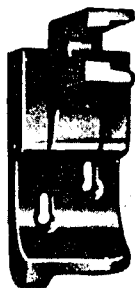
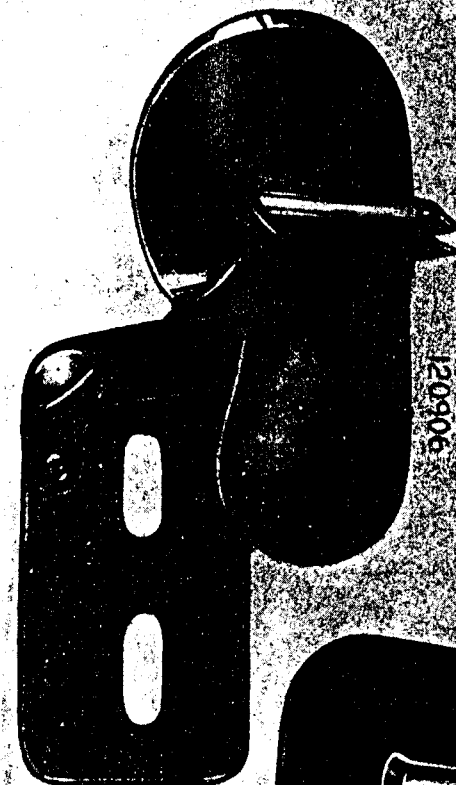


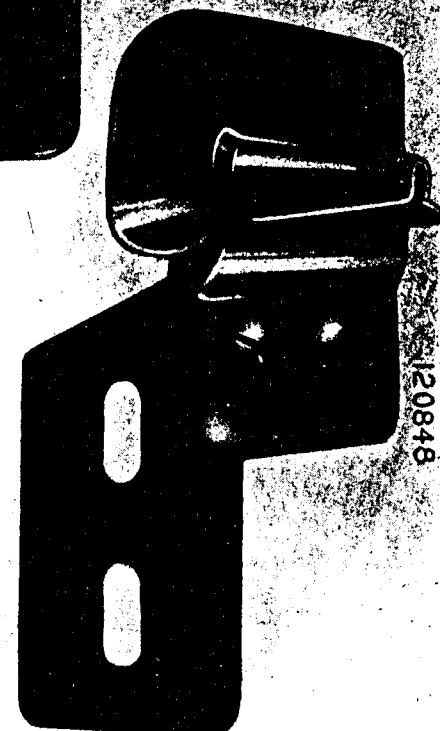
PLATE 20519--FULL SIZE



120906



1174



120848