

PFAFF

563
563-H

Unterklassen-Ausstattung

Subclass parts

Composition des sous-classes

Composición de las subclases

Erläuterungen Explanations

Légende Explicaciones

Die Liste enthält nur Nähwerkzeuge sowie unterklassenabhängige Teile. Beim Umbau in eine andere Unterklasse bzw. Ausführung können auch noch Maschinenteile erforderlich sein. Geben Sie also bei Bestellungen die genaue Bezeichnung der vorhandenen bzw. der gewünschten Ausführung an.

The list contains only gauge parts and subclass-dependent parts. For a conversion into another subclass or version machine parts may be required as well. Please state the exact classification of the existing or required version on your order.

La liste comprend uniquement des organes de couture et des pièces dépendant des sous-classes. En cas de transformation en une autre sous-classe ou une autre version, il se peut que d'autres pièces de machine soient nécessaires. C'est pourquoi nous vous prions d'indiquer, à la commande, la désignation exacte de la version existante ou souhaitée.

La lista contiene solamente órganos de costura y piezas dependientes de la subclase. En el caso de transformación en otra subclase o en otro tipo, es posible que sean necesarias piezas de la máquina. Al hacer los pedidos, indíquese la denominación exacta del tipo existente o del deseado.

- 3/1** Gesichert mit Loctite.
Secured with Loctite.
Bloqué par Loctite.
Asegurado con Loctite.
- 4** Ausführungsart bei Bestellung angeben.
Model to be stated on order.
Préciser le modèle à la commande.
Indíquese el tipo en los pedidos.
- 5** Nähmuster bzw. Material einsenden.
Submit sewing sample or material.
Joindre échantillons de couture ou matières.
Envíense muestras de costura.
- 9** Schneidabstand
Trimming margin
Distance de coupe
Margen de corte
- 9/2** Schneidabstand bei Bestellung angeben.
Trimming margin to be stated on order.
Distance de coupe; à préciser à la commande.
Margen de corte; indíquese en los pedidos.
- 12** Absteppbreite
Stitching margin
Relarge de couture
Margen de costura
- 12/2** Absteppbreite bei Bestellung angeben.
Stitching margin to be stated on order.
Indiquer le relarge de couture à la commande.
Indíquese el margen de costura en los pedidos.
- 90/32** Für Maschinen mit -900/57-972/33.
For machines with -900/57-972/33.
Pour machines avec -900/57-972/33.
Para máquinas con -900/57-972/33.

Unterklassen-Übersicht
Table of subclasses

Table des sous-classes
Tabla de subclases

Unterklasse Subclass Sous-classe Subclase	-6/01 (-900/..)	-6/01 (-900/..)	-H-6/01 (-900/..)	-8/01 (-900/..)
Arbeitsgang Operation Opération Operación	Für allgemeine Näharbeiten. Standardform des Teilesatzes. For ordinary sewing operations. Standard part set. Travaux d'utilité courante. Jeu de pièces standard. Para trabajos de costura en general. Juego de piezas estándar.	Für allgemeine Näharbeiten. Standardform des Teilesatzes. For ordinary sewing operations. Standard part set. Travaux d'utilité courante. Jeu de pièces standard. Para trabajos de costura en general. Juego de piezas estándar.	Für allgemeine Näharbeiten. Standardform des Teilesatzes. For ordinary sewing operations. Standard part set. Travaux d'utilité courante. Jeu de pièces standard. Para trabajos de costura en general. Juego de piezas estándar.	Universalteilesatz, zum Nähen mittlerer Materialien. Universal part set for sewing medium-weight materials. Jeu de pièces universel, pour matières moyennes. Juego de piezas universal para coser géneros semipesados.
Ausführung Model Version Tipo de máquina	B	BN	CN	B
Nadelstange Needle bar Barre à aiguille Barra de aguja	91-069 794-91	91-069 794-91	91-174 543-91	91-069 794-91
Stoffschieber ^[4] Feed dog Griffe Transportador inferior	91-047 547-04	91-047 816-04	91-047 816-04	91-059 392-05
Stichplatte ^[4] Needle plate Plaque à aiguille Placa de aguja	91-058 048-24	91-158 429-24	91-158 429-24	91-158 887-25 91-150 052-25 ^[90/32]
Nähfuß ^[4] Presser foot Pied presseur Pie prensateelas	91-051 736-23	91-051 736-23	91-051 736-23	91-155 599-21

Unterklassen-Übersicht
Table of subclasses

Table des sous-classes
Tabla de subclasses

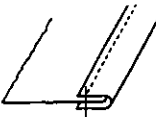
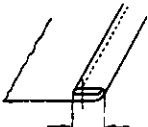
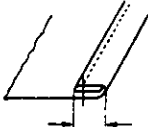
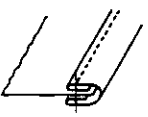
Unterklasse Subclass Sous-classe Subclase	-17/31	-19/01 (-900/..)	-19/51 (-900/..)	-34/01 (-900/..)	-39/31
Arbeitsgang Operation Opération Operación				Zum Nähen feiner Materialien. Standardform des Teilesatz. For sewing light fabrics. Standard-size parts set. Pour la couture de matières fines. Jeu de pièces standard. Para coser materiales finos. Juego de piezas estándar.	
Ausführung Model Version Tipo de maquina	B	B	B	A	B
Saumbreite in mm Hem width in mm Largeur de l'ourlet en mm Anchura del dobladillo en mm		4,0 - 15,0	1,5 - 8,0		
Nadelstange Needle bar Barre à aiguille Barra de aguja	91-069 794-91	91-069 794-91	91-069 794-91	91-069 794-91	91-069 794-91
Stoffschieber ⁴ Feed dog Griffe Transportador inferior	91-047 264-04	91-026 271-04	91-047 298-04	91-059 872-05	91-047 264-04
Nähplatte ⁴ Needle plate Plaque à aiguille Placa de aguja	91-048 680-24	91-048 519-24	91-048 664-24	91-150 437-25 91-150 085-04 ^{90/32}	91-048 680-24
Nähfuß ⁴ Presser foot Pied presseur Pie prensatelas	91-051 951-23 ^{12/2}	91-157 603-23 ⁵ ^{12/2} ¹² = 3,0 - 15,0 mm	91-052 036-93 ⁵	91-051 742-23	91-051 951-23 ^{12/2}
Apparat ⁵ Attachment Appareil Aparato	91-040 980-23	91-041 006-23			91-040 976-23
Träger Bracket Support Soporte		91-753 936-90			
Bandteiler Tape disc Plateau dérouleur Disco portacintas	91-043 943-70/995				91-043 943-70/995
Bandführung Tape guide Guide-ruban Guiacintas	91-040 392-21				

Unterklassen-Übersicht
Table of subclasses

Table des sous-classes
Tabla de subclasses

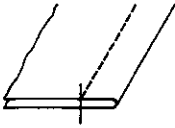
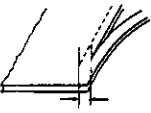
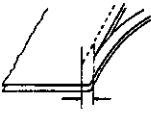
Unterklasse Subclass Sous-classe Subclase	-151/03 (-900/..)	-731/01-6/01	-731/01-6/01-900/..	-944/01 (-900/..)	-H-944/01 (-900/..)
Arbeitsgang Operation Opération Operación				Für Stepparbeiten an Schuhschäften und sonstigen Lederwaren mittels Rollfuß. For sewing operations on shoe uppers and other leather articles; machine equipped with roller presser. Pour les piqures sur tiges de chaussures et sur d'autres articles en cuir. Comprend un pied à roulette. Para trabajos de aparado en cortes de calzado y demás artículos de cuero mediante pie rodante.	Für Stepparbeiten an Schuhschäften und sonstigen Lederwaren mittels Rollfuß. For sewing operations on shoe uppers and other leather articles; machine equipped with roller presser. Pour les piqures sur tiges de chaussures et sur d'autres articles en cuir. Comprend un pied à roulette. Para trabajos de aparado en cortes de calzado y demás artículos de cuero mediante pie rodante.
Ausführung Model Version Tipo de máquina	B	B	B	A; B	CN
Schneidabstand in mm Trimming margin in mm Distance de coupe en mm Margen de corte en mm		2,5 - 12,0	4,0 - 12,0		
Nadelstange Needle bar Barre à aiguille Barra de aguja	91-069 794-91	91-069 571-92	91-069 571-92	91-069 571-92	91-174 835-92
Stoffschieber ⁴ Feed dog Griffe Transportador inferior	91-059 872-05	91-047 464-04 ^{9/2} ⁹ = 2,5 - 8,0 mm 91-047 293-04 ^{9/2} ⁹ = 10,0; 12,0 mm	91-047 464-04 ^{9/2} ⁹ = 4,0 - 8,0 mm 91-047 293-04 ^{9/2} ⁹ = 10,0; 12,0 mm	91-047 260-04	91-047 260-04
Stichplatte ⁴ Needle plate Plaque à aiguille Placa de aguja	91-150 437-25	91-048 704-93 ^{9/2} ⁹ = 2,5 - 7,0 mm 91-048 778-93 ^{9/2} ⁹ = 8,0 - 12,0 mm	91-048 704-93 ^{9/2} ⁹ = 4,0 - 7,0 mm 91-048 778-93 ^{9/2} ⁹ = 8,0 - 12,0 mm	91-048 673-23	91-150 197-04
Nähfuß ⁴ Presser foot Pied presseur Pie prensatelas	91-054 651-03	91-054 338-03 ^{9/2}	91-054 338-03 ^{9/2}		
Rollfuß ⁴ Roller presser Pied à roulette Pie rodante				91-051 155-93	91-051 155-93
Apparat ⁵ Attachment Appareil Aparato	91-461 440-21				
Messer ^{9/2} Knife Couteau Cuchilla		91-169 395-04 x 7 ⁹ = 2,5 - 5,0 mm 91-150 560-04 x 9 ⁹ = 6,0 - 12,0 mm	91-169 395-04 x 7 ⁹ = 4,0 - 5,0 mm 91-150 560-04 x 9 ⁹ = 6,0 - 12,0 mm		

**Nähwerkzeuge
Gauge parts**

**Organes de couture
Organos de costura**

91-069 571-92

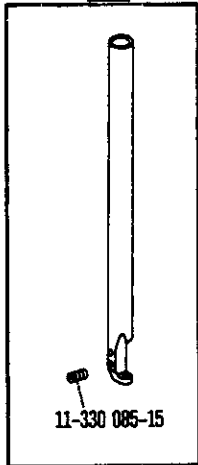

-731/01-6/01 (-900/..)
-944/01 (-900/..)

91-069 794-91

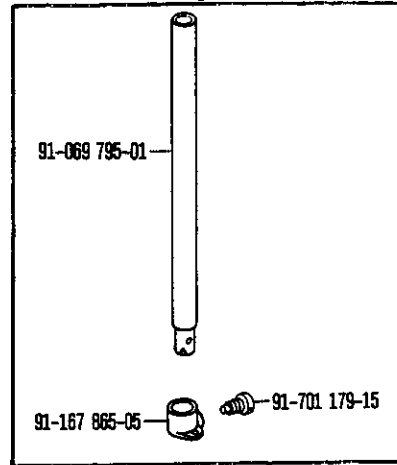

-6/01 (-900/..)
-8/01 (-900/..)
-17/31
-19/01 (-900/..)
-19/51 (-900/..)
-34/01 (-900/..)
-39/31
-151/03 (-900/..)

91-174 543-91

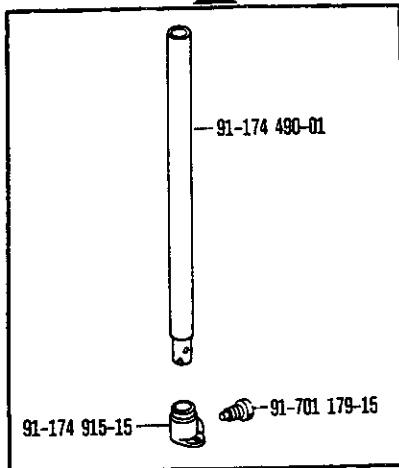

-H-6/01 (-900/..)

91-174 835-92

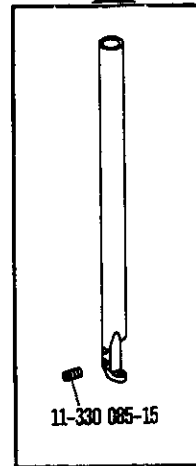

-H-944/01 (-900/..)

91-026 271-04 [4]



-19/01 (-900/..)

91-047 260-04 [4]



-944/01 (-900/..)
-H-944/01 (-900/..)

91-047 264-04 [4]



-17/31
-39/31









91-047 293-04 [4] [8/2]
[9] = 10,0 mm; 12,0 mm



-731/01-6/01 (-900/..)

Nähwerkzeuge
Gauge parts

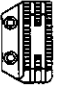
Organes de couture
Organos de costura

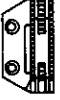
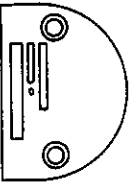
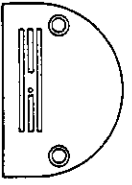
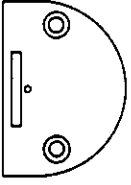
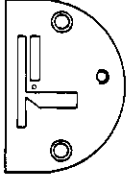
<p>91-047 298-04 </p> <p>-19/51 (-900/..)</p>	<p>91-047 464-04   = 2,5 - 8,0 mm</p> <p>-731/01-6/01  = 2,5 - 8,0 mm -731/01-6/01-900/..  = 4,0 - 8,0 mm</p>	<p>91-047 547-04 </p> <p>-6/01 (-900/..)</p>	<p>91-047 816-04 </p> <p>-6/01 (-900/..) -H-6/01 (-900/..)</p>
<p>91-059 392-05 </p> <p>-8/01 (-900/..)</p>	<p>91-059 872-05 </p> <p>-34/01 (-900/..) -151/03 (-900/..)</p>		
<p>91-048 519-24 </p> <p>-19/01 (-900/..)</p>	<p>91-048 664-24 </p> <p>-19/51 (-900/..)</p>	<p>91-048 673-24 </p> <p>-944/01 (-900/..)</p>	<p>91-048 680-24 </p> <p>-17/31 -39/31</p>

**Nähwerkzeuge
Gauge parts**

**Organes de couture
Organos de costura**

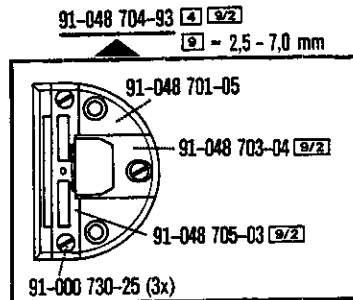

-731/01-6/01 [9] = 2,5 - 7,0 mm
-731/01-6/01-900/.. [9] = 4,0 - 7,0 mm

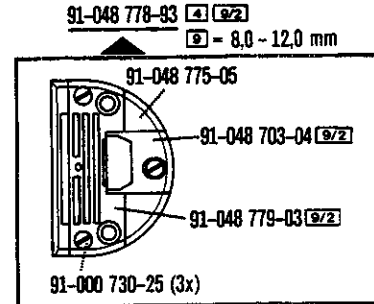

-731/01-6/01 (-900/..)

91-058 048-24 [4]

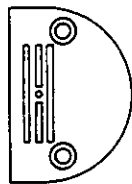

-6/01 (-900/..)

91-150 052-25 [4]

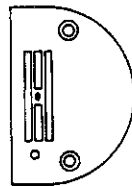

-8/01-900/57-972/33

91-150 085-04 [4]

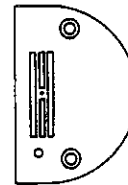

-34/01-900/57-972/33

91-150 197-04 [4]

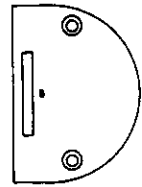

-H-944/01(-900/..)

91-150 437-25 [4]

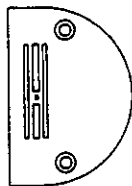

-34/01 (-900/..)
-151/03 (-900/..)

91-158 429-24 [4]

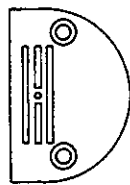

-6/01 (-900/..)
-H-6/01 (-900/..)

91-158 887-25 [4]

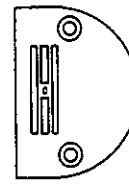

-8/01 (-900/..)

91-051 155-93 [4]

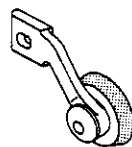

-944/01 (-900/..)
-H-944/01 (-900/..)

91-051 736-23 [4]

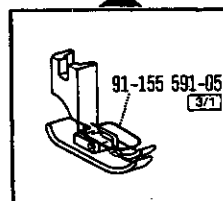

-6/01 (-900/..)
-H-6/01 (-900/..)

91-051 742-23 [4]

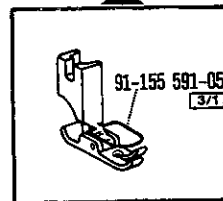

-34/01 (-900/..)

91-051 951-23 [4] [12/2]

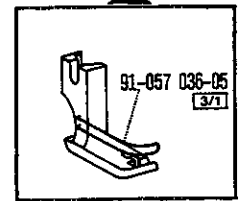

-17/31
-39/31

Nähwerkzeuge
Gauge parts

Organes de couture
Organos de costura

91-052 036-03 [4] [5]

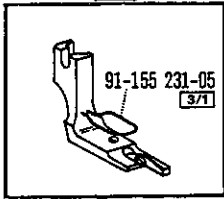

-19/51 (-900/..)

91-054 338-03 [4] [8/2]

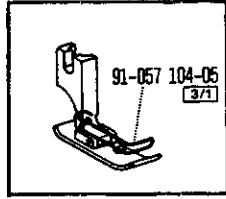

[8] = 2,5 - 12,0 mm

-731/01-6/01 (-900/..)

91-054 651-03 [4]

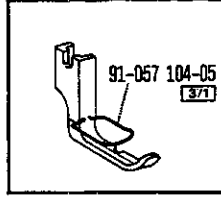

-151/03 (-900/..)

91-155 599-21 [4]

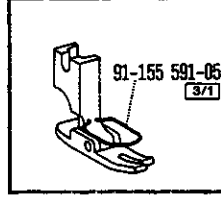

-8/01 (-900/..)

91-157 603-23 [4] [5] [12/2]

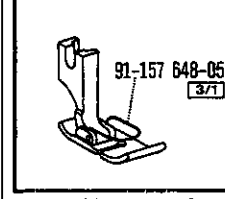

[12] = 3,0 - 15,0 mm

-19/01 (-900/..)

91-000 073-25

12-341 090-15

91-040 976-23 [5]

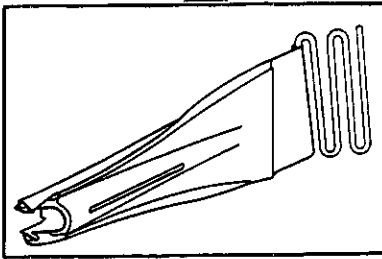

-39/31

91-000 073-25

12-341 090-15

91-040 980-23 [5]

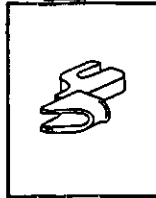

-17/31

91-041 006-23 [5]

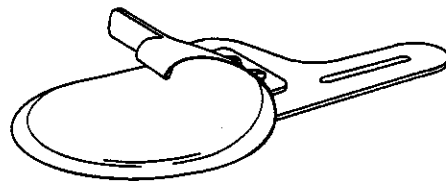

-19/01 (-900/..)

91-461 440-21 [5]

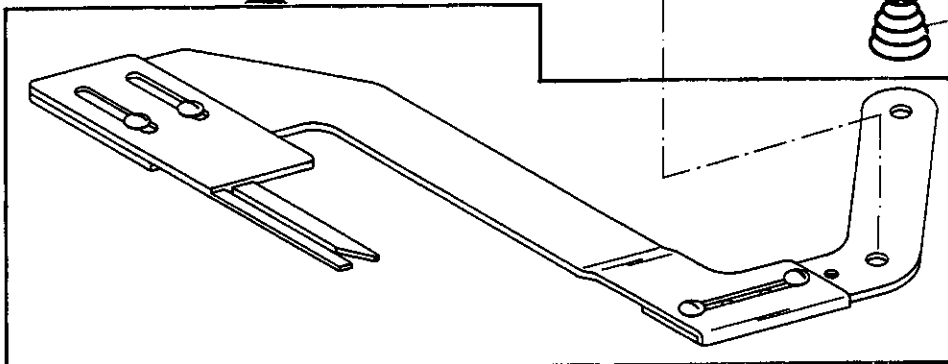

91-100 288-25

91-028 036-25

91-700 824-25

91-040 624-25

-151/03 (-900/..)

Nähwerkzeuge
Gauge parts

Organes de couture
Organos de costura

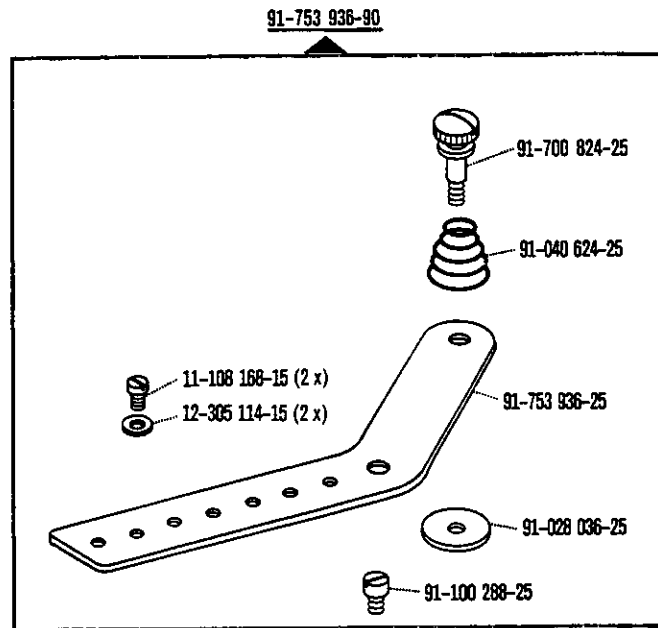

-19/01 (-900/-)

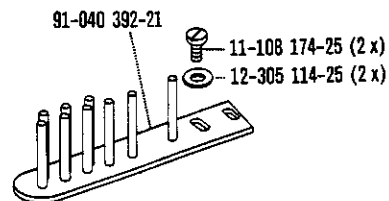

-17/31

Nähwerkzeuge
Gauge parts

Organes de couture
Organos de costura

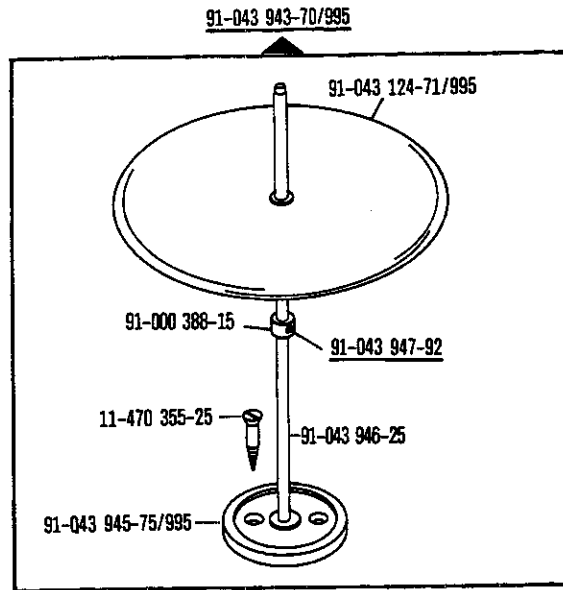

-17/31
-39/31

91-168 395-04 x 7 [9/2]
[9] = 2,5 - 5,0 mm



-731/01-6/01 [9] = 2,5 - 5,0 mm
-731/01-6/01-900/.. [9] = 4,0 - 5,0 mm

91-170 560-04 x 9 [9/2]
[9] = 6,0 - 12,0 mm



-731/01-6/01 (-900/..)

PFAFF