PFAFF[®] **444**

Bestandteileliste

List of spare parts

Liste des pièces détachées

Lista de piezas de repuesto

Die vorliegende Bestandteilliste enthält alle Teile der Hauptklasse und der zur Zeit lieferbaren Unterklassen.

Einen Überblick über die Aufgliederung der Liste gibt die Inhaltsübersicht auf Seite 4.

Die Teile sind so abgebildet, wie sie in der Maschine zusammengehören.

Alle für die Teilebestellung wichtigen Hinweise sind auf dem Erläuterungsblatt zusammengefaßt.

Aggregate, die nichtaustauschbare Teile enthalten, sind auf den Bildseiten eingerahmt, z. B. Fadengeber-Aggregat.

Das Erstellungsdatum ist auf den einzelnen Seiten oben rechts angegeben.
Bei Austausch bitte Datum beachten.

Das Nummernverzeichnis enthält neben dem Verzeichnis der Teilenummern mit Seitenangabe auch die Zusammensetzung der einzelnen Gruppenteile.

Ergänzungen und Änderungen, die dem Fortschritt dienen, behalten wir uns vor. Sie werden durch den Änderungsdienst bekanntgegeben.

Ergänzungsblätter die nachgeliefert werden, heften Sie bitte hinter dem Nummernverzeichnis ein.

This spare parts catalogue contains all parts of the main class and all subclasses available at present.

For the various sections of this catalogue, please refer to the »Contents« on page 4.

The parts are illustrated as they are arranged in the machine.

All points which have to be observed when ordering parts are compiled on an explanatory sheet.

Assemblies containing non-exchangeable parts, e. g. take-up assembly, are boxed in on the illustration pages.

The date of preparation of the individual pages is indicated in the upper right-hand corner.
Please note the new date on revised sheets.

The numerical index not only lists the part numbers and the page on which each part is illustrated, but also shows the composition of the individual sub-assemblies.

Subject to alterations in design serving progress. These will be announced by special circulars.

Please file supplementary sheets after the numerical index.

La présente liste de pièces détachées contient toutes les pièces de la classe fondamentale et des sous-classes livrables actuellement.

La table des matières, page 5, donne un aperçu sur la subdivision de la liste.

Les pièces détachées sont groupées suivant leur disposition dans la machine.

Tous les éléments importants pour la commande sont réunis sur la feuille complémentaire.

Les éléments contenant des pièces non interchangeables sont encadrés sur les tableaux (éléments du levier releveur de fil, par exemple).

La date de parution des différentes planches est indiquée dans l'angle supérieur droit. Veiller à n'utiliser toujours que les planches les plus récentes.

Le tableau des numéros indique, en plus des numéros des pièces, les pages sur lesquelles ces pièces sont représentées et la composition des différents groupes de pièces.

Tout changement réservé, au service du progrès. Ils seront portés à votre connaissance par l'intermédiaire de notre service de mise à jour.

Veillez insérer après le tableau des numéros les addenda livrés ultérieurement.

La presente lista de piezas de repuesto contiene todas las piezas de la clase principal y de las subclases que pueden ser suministradas hasta la fecha.

En la página 5, bajo el título »contenido«, puede verse un resumen de la división de la »lista de piezas«.

Las piezas están ilustradas tal como aparecen en la máquina.

Todas las advertencias importantes relativas al pedido de piezas se hallan recopiladas en una hoja de explicaciones.

Los agregados que contengan piezas no recambiables, como, p. e., grupo del tirahilos, se hallan enmarcados en las páginas ilustradas.

La fecha en que cada una de las páginas ha sido editada se halla indicada en la esquina derecha superior. Al reemplazar unas hojas por otras se ruega tener en cuenta la fecha.

El índice numérico contiene, aparte de los números de las piezas con las páginas, la composición de cada uno de los grupos de piezas.

Dejamos a salvo suplementos y modificaciones técnicas que puedan tener lugar y que se darán a conocer a través de nuestro servicio informativo.

Las hojas suplementarias que se envíen posteriormente, les rogamos las coloquen a continuación del índice numérico.

	Seite
Erläuterungen	6
Technische Daten:	
Allgemein	10
Nähgeschwindigkeitstabelle	12
Keilriemenscheiben-Vergleichstabellen	13
Hauptklasse Pfaff 444:	
Kopfteile	17
Armteile	21
Grundplattenteile	25
Zubehörteile	33
Ergänzungsteile der Pfaff 444-900/11	39
Ergänzungsteile der Pfaff 444-900/01	45
Presserfußautomatik Pfaff -910/01	47
Nadelpositionier-Einrichtung Pfaff -913/01; -913/02; -913/04	49
Ergänzungsteile der Pfaff 444-944/01	53
Unterklassen-Übersicht (Tabelle).....	55
Nadelabstandstabelle	59
Nähwerkzeuge	63
Nummernverzeichnis	69

	Page
Explanations	7
Technical data:	
General	10
Table of sewing speeds	12
V-belt pulley comparison chart	13
Main class of the Pfaff 444:	
Front parts	17
Arm parts	21
Bedplate parts	25
Accessory parts	33
Complementary parts for the Pfaff 444-900/11	39
Complementary parts for the Pfaff 444-900/01	45
Automatic presser foot lifter, Pfaff -910/01	47
Automatic needle positioner, Pfaff -913/01; -913/02; -913/04	49
Complementary parts for the Pfaff 444-944/01	53
Table of subclasses	55
Needle gauge chart	59
Organization parts	63
Numerical index	69

Légende	
Caractéristiques techniques:	
Généralités	
Tableau des vitesses de couture	
Tableaux de comparaison des poulies pour courroies en V	
Classe fondamentale de la Pfaff 444:	
Pièces de tête	
Pièces de bras	
Pièces du plateau fondamental	
Accessoires	
Pièces complémentaires de la Pfaff 444-900/11	
Pièces complémentaires de la Pfaff 444-900/01	
Releveur automatique du pied presseur de la Pfaff -910/01	
Dispositif de positionnement de l'aiguille Pfaff -913/01; -913/02; -913/04	
Pièces complémentaires de la Pfaff 444-944/01	
Table des sous-classes	
Tableau des écartements d'aiguilles	
Organes de couture	
Tableau des numéros	

Explicaciones	
Datos técnicos:	
Características generales	
Tablas de velocidad de costura	
Cuadros comparativos de poleas para correas en „V“	
Clase principal de la Pfaff 444:	
Piezas de la cabeza	
Piezas del brazo	
Piezas de la placa-base	
Accesorios	
Piezas especiales de la Pfaff 444-900/11	
Piezas especiales de la Pfaff 444-900/01	
Alzaprensatelas automático Pfaff -910/01	
Dispositivo para posicionar la aguja Pfaff -913/01; -913/02; -913/04	
Piezas especiales de la Pfaff 444-944/01	
Tabla de subclases	
Tabla de distancias entre agujas	
Elementos de costura	
Indice numérico	

00-000 000-00

Hauptgruppenteil:
bestehend aus Gruppen- und Einzelteilen (siehe Nummernverzeichnis).

00-000 000-00

Gruppenteil:
bestehend aus Einzelteilen, bzw. aus Einzelteilen mit Ergänzung
(siehe Nummernverzeichnis)

00-000 000-00

Einzelteil mit Ergänzung (siehe Nummernverzeichnis),
z. B. Stelling mit Schrauben, Nadelstange mit Nadelbefestigungsschraube usw..

00-000 000-00

Einzelteil

A

Ausführung A (für feine Materialien)

B

Ausführung B (für mittlere Materialien)

S

Für Stoff

L

Für Leder

45

Stichlänge 4,5 mm

N

Stichlänge 6.0 mm

Unterklassenabhängig. (Teilenummer siehe Unterklassen-Übersicht Seite 55).

1

Zur Reparatur einsenden

2

Markierung (Punkte, Stiche oder Zahl)*

3

Eingeklebt

4

Ausführungsart (A oder B)*

6

Nadelstärke und Spitzenform*

10

Nadelabstand*

22

Im Zubehör

23

Stoffdurchgangabhängig: für 7 mm Nadelsystem 134,
für 9 mm Nadelsystem 134-35.

28

Sonderausführung

30

Frühere Ausführung (im Ersatzfall wieder bestellen)

31

Einzelteil nicht austauschbar.
Im Ersatzfall vollständiges Aggregat (eingerahmte Teile) bestellen oder zur Reparatur
einsenden.

32

Nicht mehr im Programm

70

Frühere Ausführung (Nadellager-Außendurchmesser = 13 mm).
Im Ersatzfall wieder bestellen.

00-000 000-00	Assembly, consisting of sub-assemblies and component parts (see numerical index)
<u>00-000 000-00</u>	Sub-assembly, consisting of component parts and/or of component and complementary parts (see numerical index)
<u>00-000 000-00</u>	Component part with complementary part (see index), e. g. collar with screws and needle bar with needle set screw.
00-000 000-00	Component part
A	Model A for sewing thin and lightweight materials
B	Model B for sewing medium-weight materials
S	For fabric
L	For leather
4,5	Stitch length 4,5 mm
N	Stitch length 6,0 mm
<input type="checkbox"/>	Subclass-dependent. (For part number please refer to table of subclasses on p. 55)
1	Replaced by reconditioned assembly in exchange for defective parts
2	Marking (dots, strokes or numbers)*
3	Part cemented
4	Model (A or B)*
6	Needle size and style of point*
10	Needle gauge*
22	Included in accessories
23	Dependent on fabric clearance: for 7 mm, needle system 134 for 9 mm, needle system 134-35
28	Special version
30	Earlier version (to be re-ordered for replacement purposes)
31	Cannot be exchanged singly. If defective, order complete assembly (boxed-in parts) or return same for repair.
32	No longer supplied
70	Old version (O. D. of needle bearing = 13 mm). To be re-ordered for replacement purposes.

* State on order

00-000 000-00	Groupe principal de pièces: composé de groupes de pièces détachées (cf. tableau des numéros)
<u>00-000 000-00</u>	Groupe de pièces: composé de pièces détachées et/ou de pièces détachées avec complément (cf. tableau des numéros)
<u>00-000 000-00</u>	Pièce détachée avec pièces complémentaires (cf. tableau des numéros) Par exemple, bague avec vis, barre à aiguille avec vis de fixation d'aiguille, etc.
00-000 000-00	Pièce détachée
A	Modèle A pour la couture de tissus fins et légers
B	Modèle B pour la couture de tissus moyens
S	Pour tissu
L	Pour cuir
4,5	Longueur du point 4,5 mm
N	Longueur du point 6,0 mm
<input type="checkbox"/>	Pièce fonction de la sous-classe. (Pour le numéro, cf. tableau des sous-classes, page 55)
1	Pour échange, nous envoyer élément complet
2	Repères (points, traits ou chiffres)*
3	Pièce collée
4	Version (A ou B)*
6	Grosseur et forme de la pointe de l'aiguille*
10	Ecartement des aiguilles*
22	Joint aux accessoires
23	Fonction du passage sous le pied: système d'aiguille 134 pour 7,0 mm système d'aiguille 134-35 pour 9,0 mm
28	Version spéciale
30	Ancienne version (à commander à nouveau pour échange)
31	Pièces seules non interchangeables. Si nécessaire, commander élément complet (encadré) ou le renvoyer pour réparation.
32	Rayé du programme
70	Ancienne version (diamètre extérieur du roulement à aiguilles = 13 mm). A commander à nouveau pour échange.

00-000 000-00

Grupo principal de piezas:
compuesto de subgrupos de piezas individuales (véase el índice numérico)

00-000 000-00

Subgrupo de piezas:
compuesto de piezas individuales y/o piezas ind. con pieza complementaria
(véase el índice numérico)

00-000 000-00

Pieza individual con pieza complementaria (véase el índice numérico)
p. ej. anillo de ajuste con tornillo; barra de aguja con tornillo de fijación, etc.

00-000 000-00

Pieza individual

- A** Tipo A, para coser telas ligeras y delgadas
- B** Tipo B, para coser telas medianas
- S** Para tela
- L** Para cuero
- 4,5** Largo de puntada 4,5 mm
- N** Largo de puntada 6,0 mm
- La pieza depende de la subclase. (Para el número de pieza, véase la tabla de subclases pág. 55)
- 1** Envíesenos para su reparación
- 2** Señales (puntos, rayas o cifras)*
- 3** Pieza pegada
- 4** Tipo (A o B)*
- 6** Grosor de aguja y forma de la punta*
- 10** Distancia entre agujas*
- 22** En los accesorios
- 23** Dependiente del espacio de pasaje de la tela: para 7 mm sistema de agujas 134
para 9 mm sistema de agujas 134-35
- 28** Tipo especial
- 30** Tipo anterior (en caso de sustitución pidase de nuevo)
- 31** No es recambiable individualmente. En caso de sustitución pidase el agregado completo (pieza en marcada), o envíese para su reparación.
- 32** Excluida del programa
- 70** Tipo anterior (diámetro exterior del cojinete de agujas = 13 mm).
En caso de sustitución pidase de nuevo.

Zweinadel-Doppelsteppstich-Spezial-Schnellnäher

Two-needle, lockstitch, high-speed sewing machine

Piqueuse ultra-rapide spéciale à deux aiguilles, à point noué

Pespuntadora rápida especial de dos agujas

Unterklasse	Ausführung	Nadelabstand in mm				Nadeldiagonalabstand in mm	Stichlänge max in mm
Subclass	Model	Needle gauge in mm				Diagonal needle distance in mm	Maximum stitch length in mm
Sous-classe	Version	Ecartement des aiguilles en mm				Ecartement diagonal des aiguilles en mm	Longueur maximale du point en mm
Subclase	Tipo	Distancia entre agujas en mm				Distancia diagonal entre agujas en mm	Largo máximo de puntada en mm
-6/01 -6/01-900/11	A	0,8 1,6*	1,0 1,8	1,2 2,0*	1,4 2,2	2,4	siehe auch Nähgeschwindigkeitstabelle Seite 12 see table of sewing speeds on p. 12 cf. tableau des vitesses de couture, page 12 véase el cuadro de velocidades de costura en la pág. 12
	B	1,2 2,0*	1,4 2,2	1,6* 1,8	1,8	3,2	
	A; B	2,4* 5,2 8,0* 12,0* 16,0*	3,2* 6,0* 9,2 13,2 17,2	4,0 6,4* 10,0* 14,0* 18,0*	4,8* 7,2* 11,2 15,2 20,0*		
-944/01 -944/01-900/11	A	0,8 1,6*	1,0 1,8	1,2 2,0	1,4 2,2	2,4	
	B	1,2 2,0*	1,4 2,2	1,6* 1,8	1,8	3,2	
	A; B	2,4* 5,2	3,2* 6,0*	4,0	4,8*		

Zweinadel-Doppelsteppstich-Spezial-Schnellnäher

Two-needle, lockstitch, high-speed sewing machine

Piqueuse ultra-rapide spéciale à deux aiguilles, à point noué

Pespuntadora rápida especial de dos agujas

Nadeldicke in 1/100 mm	Stoffdurchgang in mm	Kraftbedarf in PS	Motordrehzahl U/min	Nähgeschwindigkeit bis max. Stiche/m
Needle size in 1/100 mm	Fabric clearance in mm	Power consumption HP	Motor speed r. p. m.	Maximum sewing speed in s. p. m.
Grosseur de l'aig. en 1/100 ^e de mm	Passage sous le pied presseur en mm	Force motrice nécessaire CV	Régime moteur trs/mn	Vitesse de couture maximale points/n
Grosor de aguja en 1/100 de mm	Pasaje del material en mm	Potencia motriz CV	Velocidad rotativa del motor, rev. p. m.	Velocidad de cosi- punt. máx. p. m.
A = 60-70 B = 80-100	7*; 9	¾	2800/50 Hz (c/s)	4500
			3400/60 Hz (c/s) 1700/60 Hz (c/s)	4500 3000
A = 60-70 B = 80-100	7*; 9	¾	2800/50 Hz (c/s)	4500
			3400/60 Hz (c/s) 1700/60 Hz (c/s)	4500 3000

siehe auch Nähgeschwindigkeitstabelle Seite 12
 see table of sewing speeds on p. 12
 cf. tableau des vitesses de couture, page 12

* Standardausführung
 Standard version

Nähgeschwindigkeitstabelle

Table of sewing speeds

Tableau des vitesses de couture

Cuadro de velocidades de costura

Unterklasse	Nadelabstand in mm	Stichlänge in mm	Nähgeschwindigkeit bis max. Stiche/min.
Subclass	Needle gauge in mm	Stitch length in mm	Maximum sewing speed in s. p. m.
Sous-classe	Ecartement des aiguilles en mm	Longueur du point en mm	Vitesse de couture maximale points/mn
Subclase	Distancia entre agujas agujas en mm	Largo de puntada en mm	Velocidad de cosido, punt. máx. p. m.
	0,8-8,0	4,5*	4500
	9,2-15,2	4,5*	4000
-6/01 -6/01 -900/11 -944/01 -944/01 -900/11	16-20,0	4,5*	3500
	0,8-15,2	6,0	3500
	16-20,0	6,0	3000

Keilriemenscheiben-Vergleichstabelle für Motordrehzahl 2800/50 Hz

V-belt pulley comparison chart for a motor speed of 2800 r. p. m. at 50 c/s

Tableau de comparaison des poulies pour courroies en V pour une vitesse de moteur de 2800 t/mn/50 Hz

Cuadro comparativo de poleas para correas en »V« para motores de 2800 rev./50 c/s

Nähgeschwindigkeit: Stiche/min.	Handrad-Durchmesser ¹⁾ in mm	Keilriemenscheiben- Durchmesser ¹⁾ in mm	Teilenummer für Keilriemenscheibe
Sewing speed s. p. m.	Balance wheel dia. ¹⁾ in mm	V-belt pulley diameter ¹⁾ in mm	Part number of V-belt pulley
Vitesse de couture points/mn	Diamètre du volant ¹⁾ en mm	Diamètre de la poulie à gorge ¹⁾ en mm	Numéro de pièce de la poulie à gorge
Velocidad de cosido: punt. p. m.	Diámetro del volante ¹⁾ en mm	Diámetro de la polea para correa en »V« ¹⁾ en mm	Número de pieza de polea para correa en »V«
3000	65	71	16-437 030-05
3100	65	71	16-437 030-05
3200	65	75	16-437 040-05
3300	65	75	16-437 040-05
3400	65	80	16-437 050-05
3500	65	80	16-437 050-05
3600	65	85	16-437 060-05
3800	65	90	16-437 070-05
4000	65	95	16-437 080-05
4300	65	100	16-437 090-05
4500	65	106	16-437 100-05

¹⁾ Wirksamer Durchmesser · Effective diameter · Diamètre effectif · Diámetro efectivo

Keilriemenscheiben-Vergleichstabelle für Motordrehzahl 1700/60 Hz

V-belt pulley comparison chart for a motor speed of 1700 r. p. m. at 60 c/s

Tableau de comparaison des poulies pour courroies en V pour une vitesse de moteur de 1700 t/mn/60 Hz

Cuadro comparativo de poleas para correas en »V« para motores de 1700 rev./60 c/s

Nähgeschwindigkeit: Stiche/min.	Handrad-Durchmesser ¹⁾ in mm	Keilriemenscheiben- Durchmesser ¹⁾ in mm	Teilenummer für Keilriemenscheibe
Sewing speed s. p. m.	Balance wheel dia. ¹⁾ in mm	V-belt pulley diameter ¹⁾ in mm	Part number of V-belt pulley
Vitesse de couture points/mn	Diamètre du volant ¹⁾ en mm	Diamètre de la poulie à gorge ¹⁾ en mm	Numéro de pièce de la poulie à gorge
Velocidad de cosido: punt. p. m.	Diámetro del volante ¹⁾ en mm	Diámetro de la polea para correa en »V« ¹⁾ en mm	Número de pieza de polea para correa en »V«
3000	65	118	16-437 120-05
3100	65	118	16-437 120-05
3200	65	125	16-437 130-05

Keilriemenscheiben-Vergleichstabelle für Motordrehzahl 3400/60 Hz

V-belt pulley comparison chart for a motor speed of 3400 r.p.m. at 60 c/s

Tableau de comparaison des poulies pour courroies en V pour une vitesse de moteur de 3400 t/mn/60 Hz

Cuadro comparativo de poleas para correas en »V« para motores de 3400 rev./60 c/s

Nähgeschwindigkeit: Stiche/min.	Handrad-Durchmesser ¹⁾ in mm	Keilriemenscheiben- Durchmesser ¹⁾ in mm	Teilenummer für Keilriemenscheibe
Sewing speed s. p. m.	Balance wheel dia. ¹⁾ in mm	V-belt pulley diameter ¹⁾ in mm	Part number of V-belt pulley
Vitesse de couture points/mn	Diamètre du volant ¹⁾ en mm	Diamètre de la poulie à gorge ¹⁾ en mm	Numéro de pièce de la poulie à gorge
Velocidad de cosido: punt. p. m.	Diámetro del volante ¹⁾ en mm	Diámetro de la polea para correa en »V« ¹⁾ en mm	Número de pieza de polea para correa en »1)
3300	65	63	16-437 010-05
3400	65	63	16-437 010-05
3500	65	67	16-437 020-05
3600	65	67	16-437 020-05
3800	65	71	16-437 030-05
4000	65	75	16-437 040-05
4300	65	80	16-437 050-05
4500	65	85	16-437 060-05

¹⁾ Wirksamer Durchmesser · Effective diameter · Diamètre effectif · Diámetro efectivo

Kopfteile

Front parts

Pièces de tête

Piezas de la cabeza

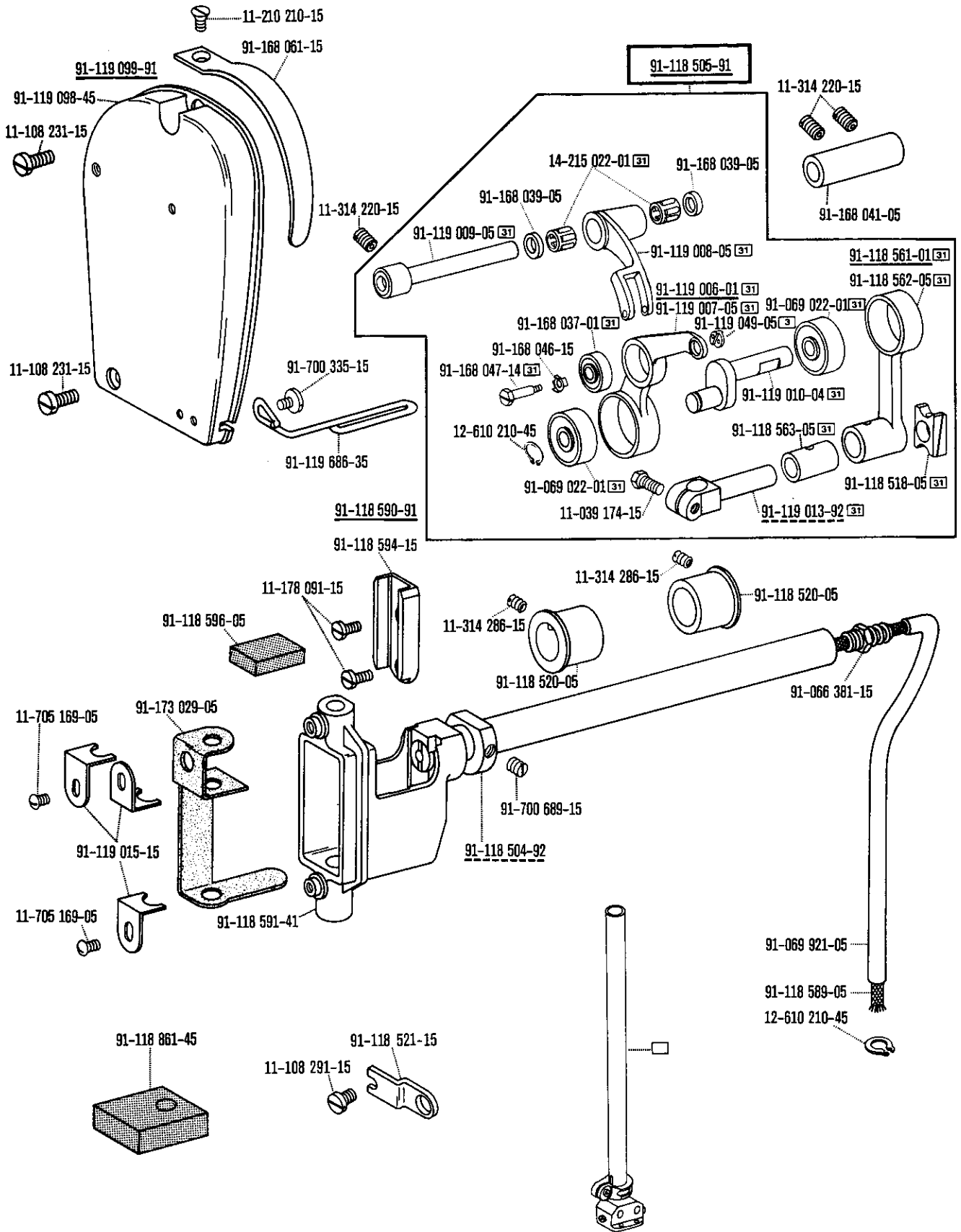

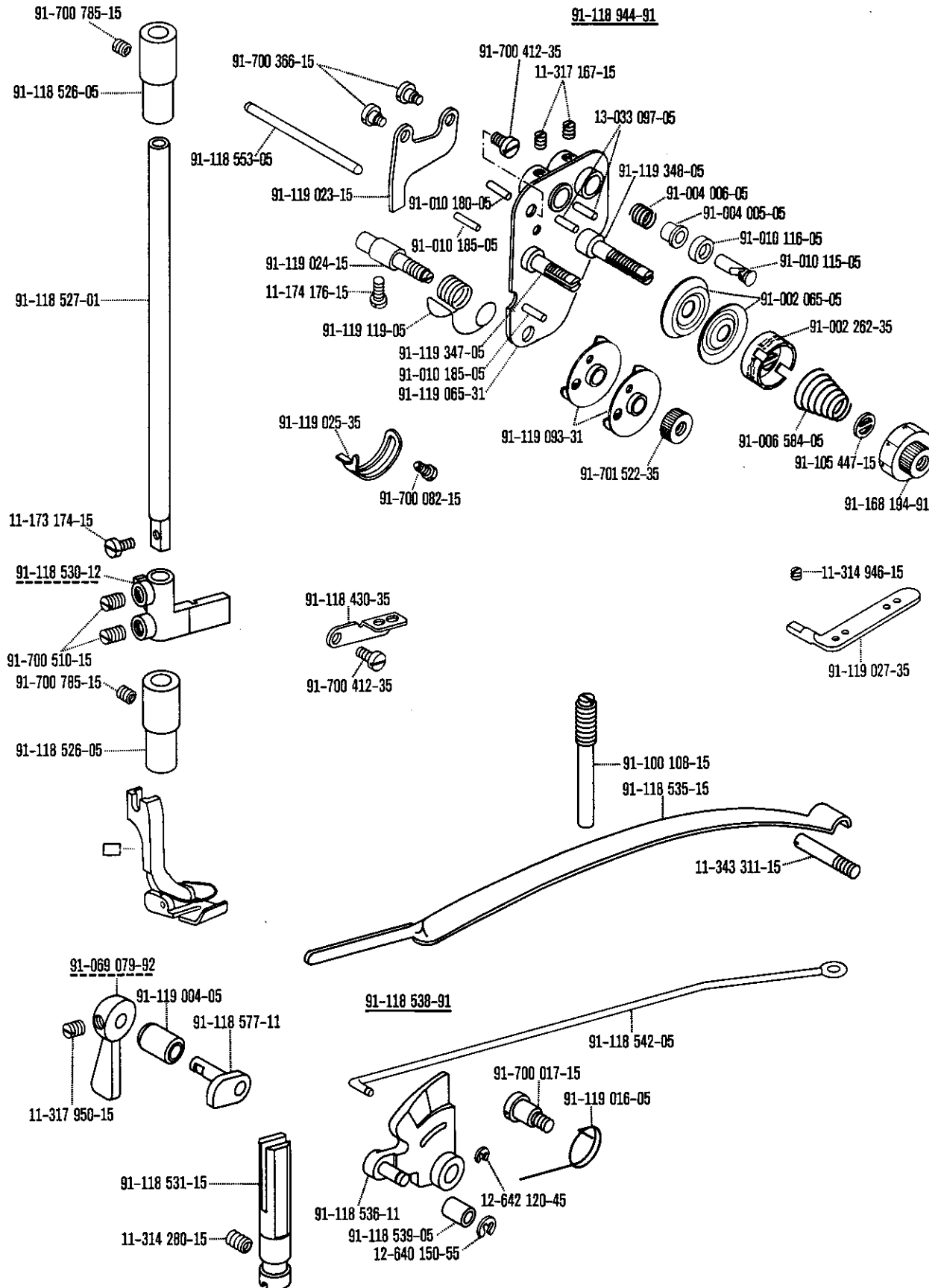

Armteile

Arm parts

Pièces de bras

Piezas del brazo

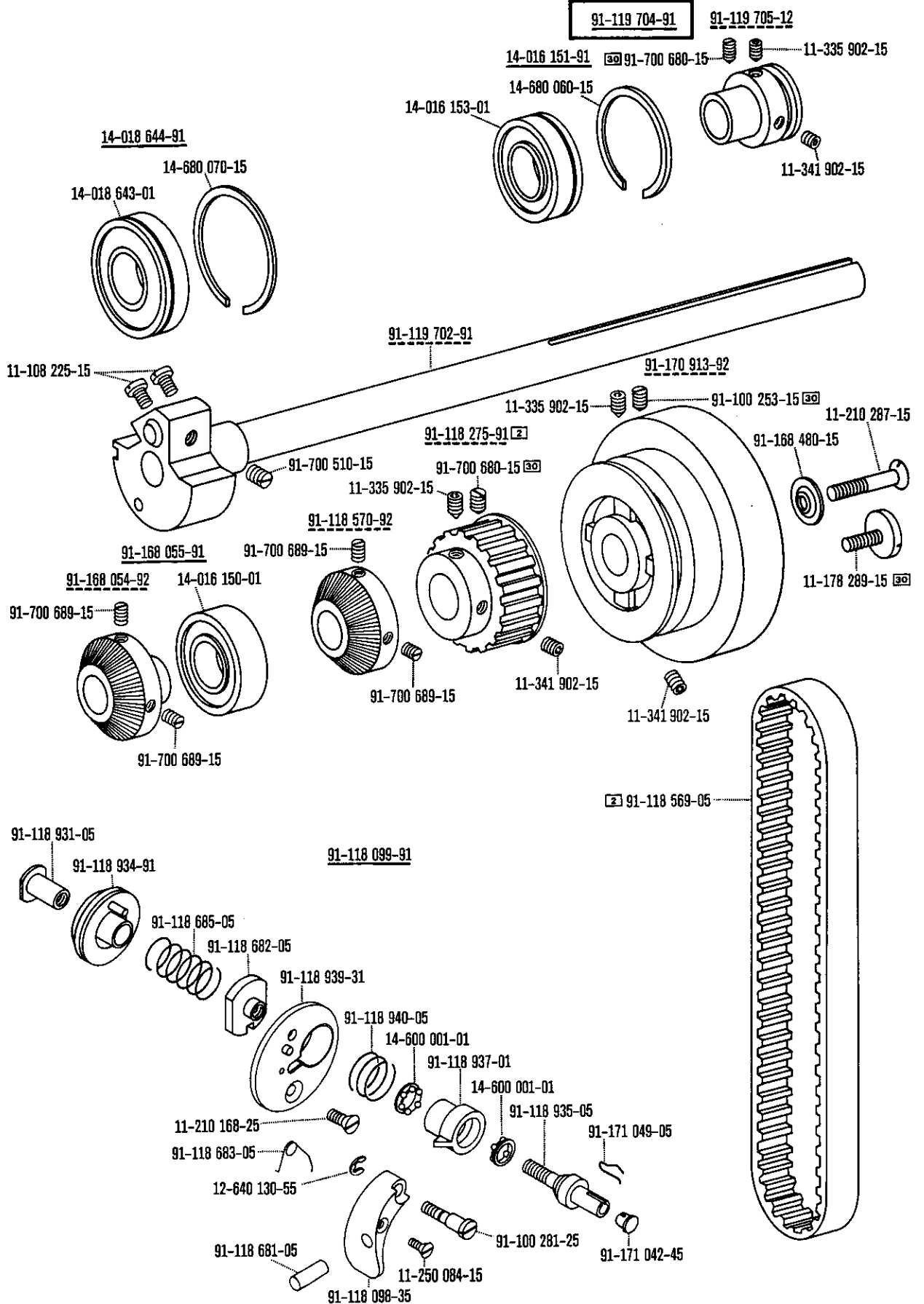

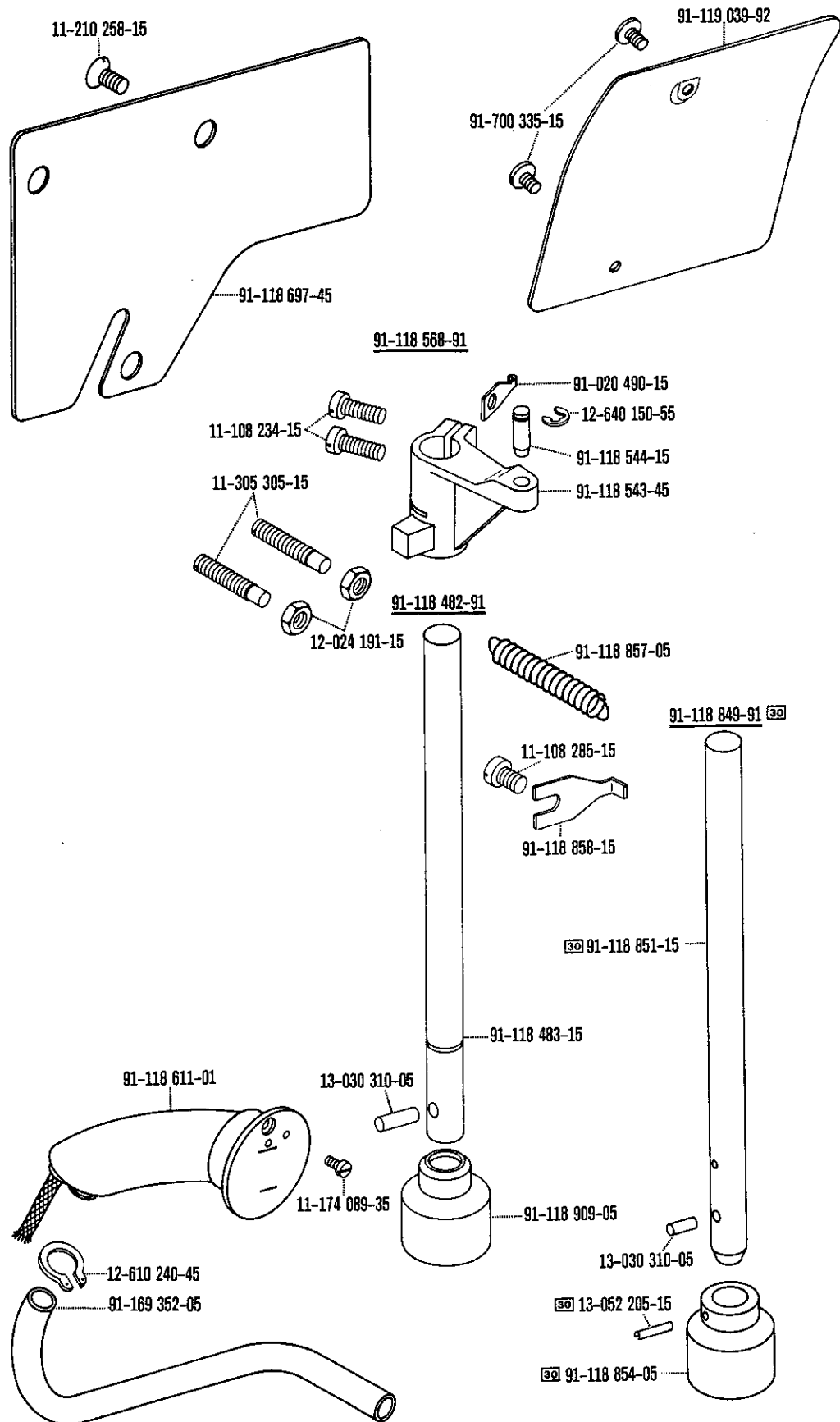

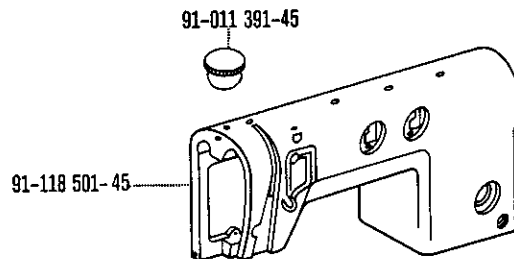
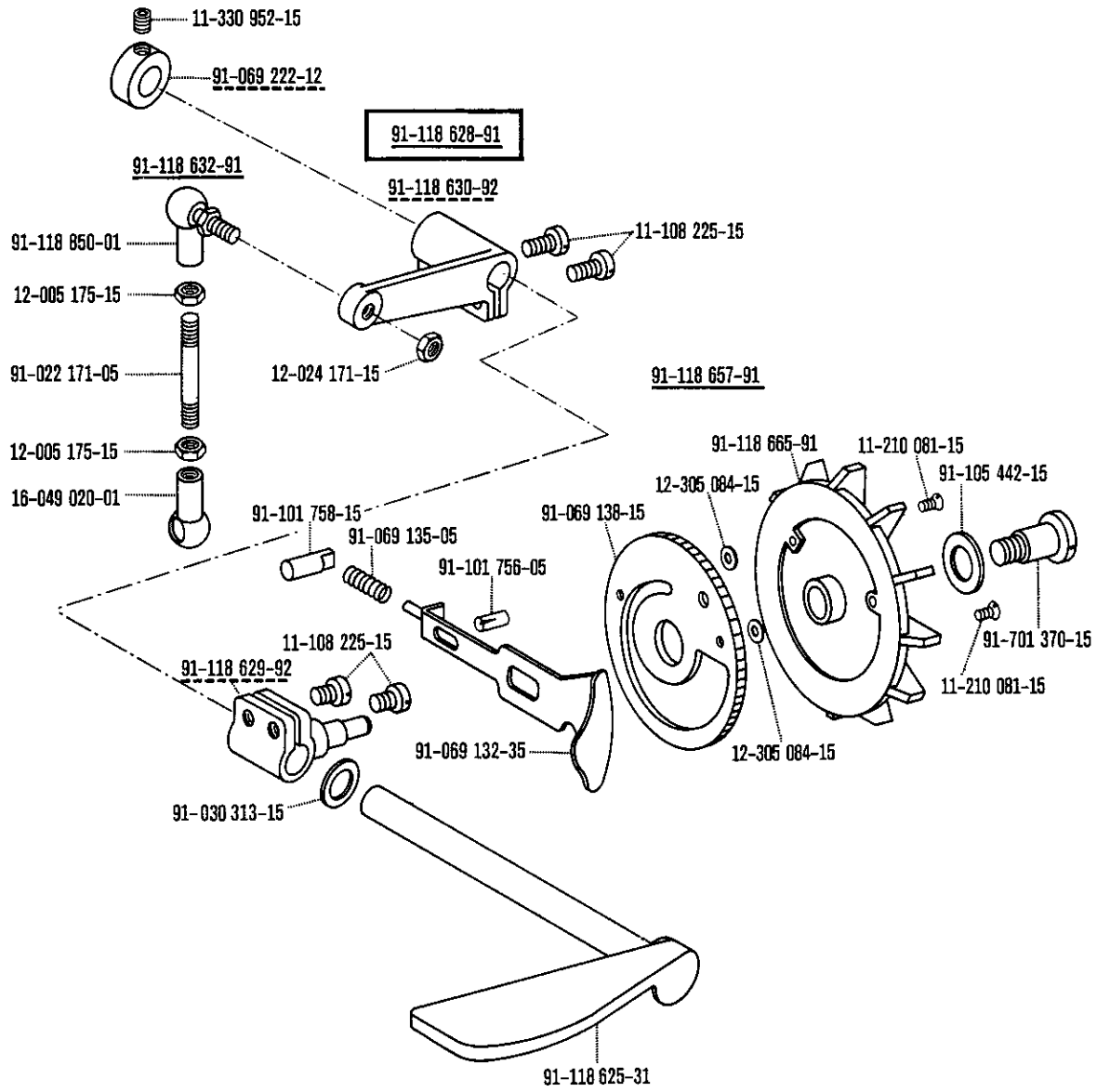

Grundplattenteile

Bedplate parts

Pièces du plateau fondamenta

Piezas de la placa-base

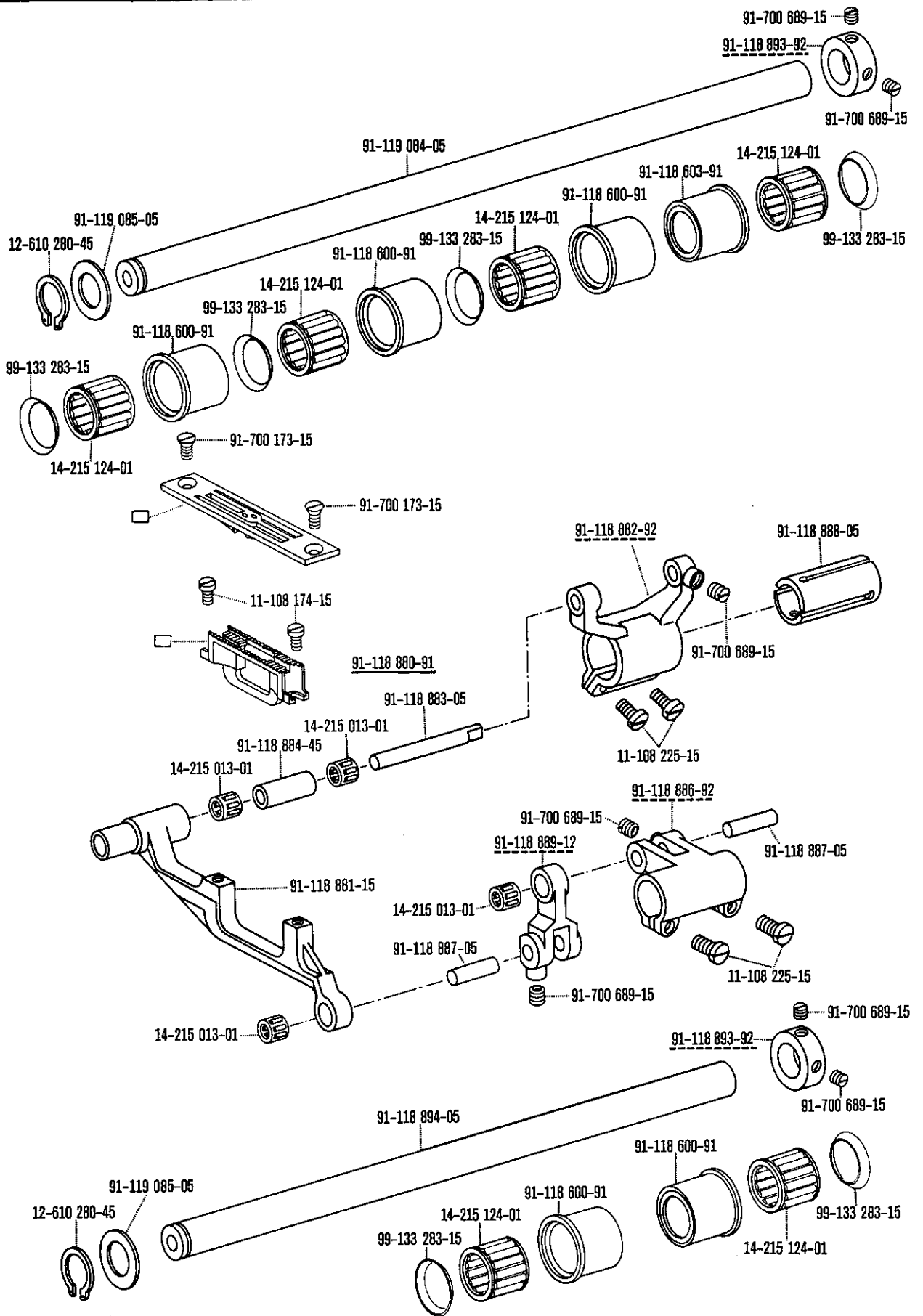

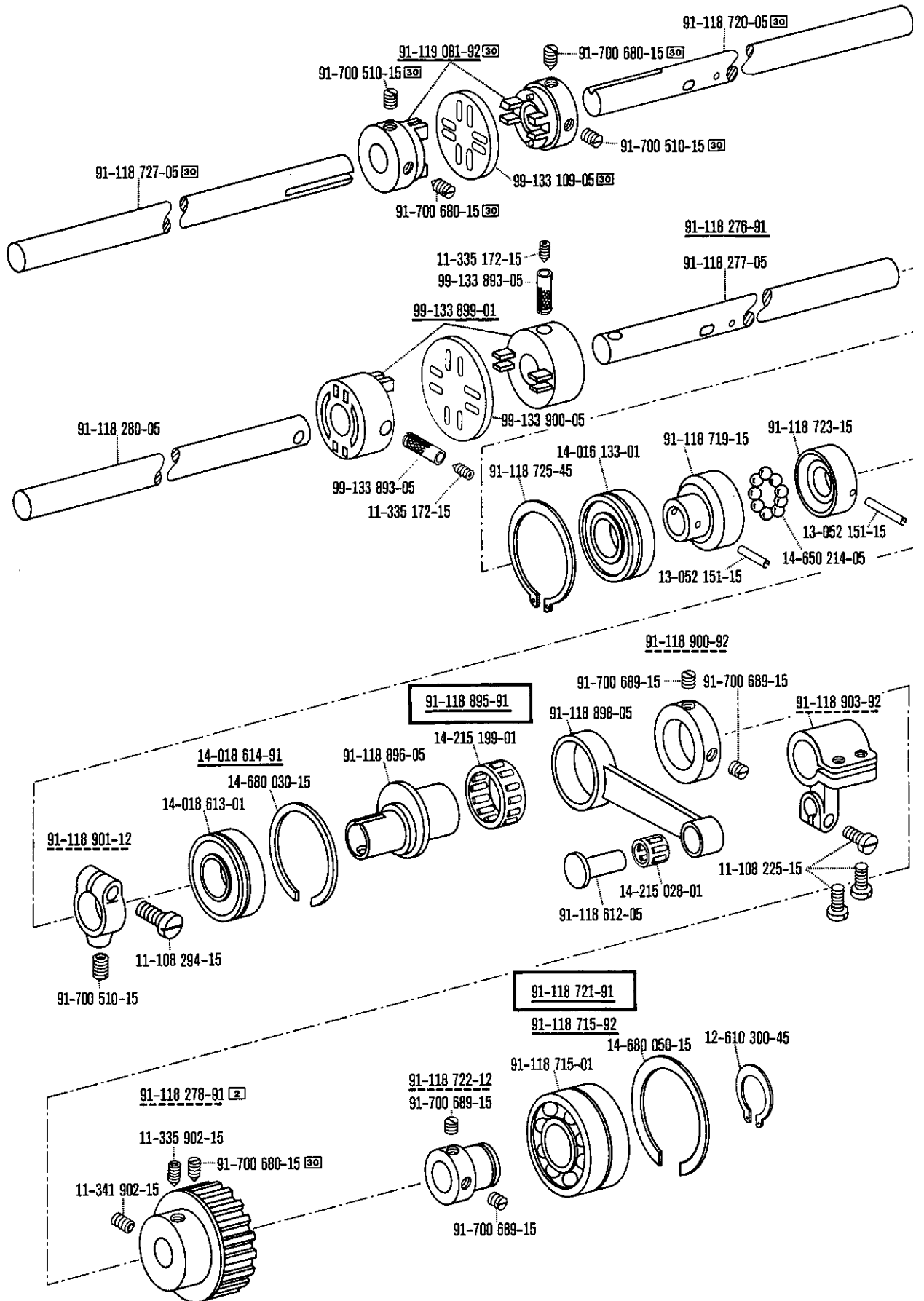

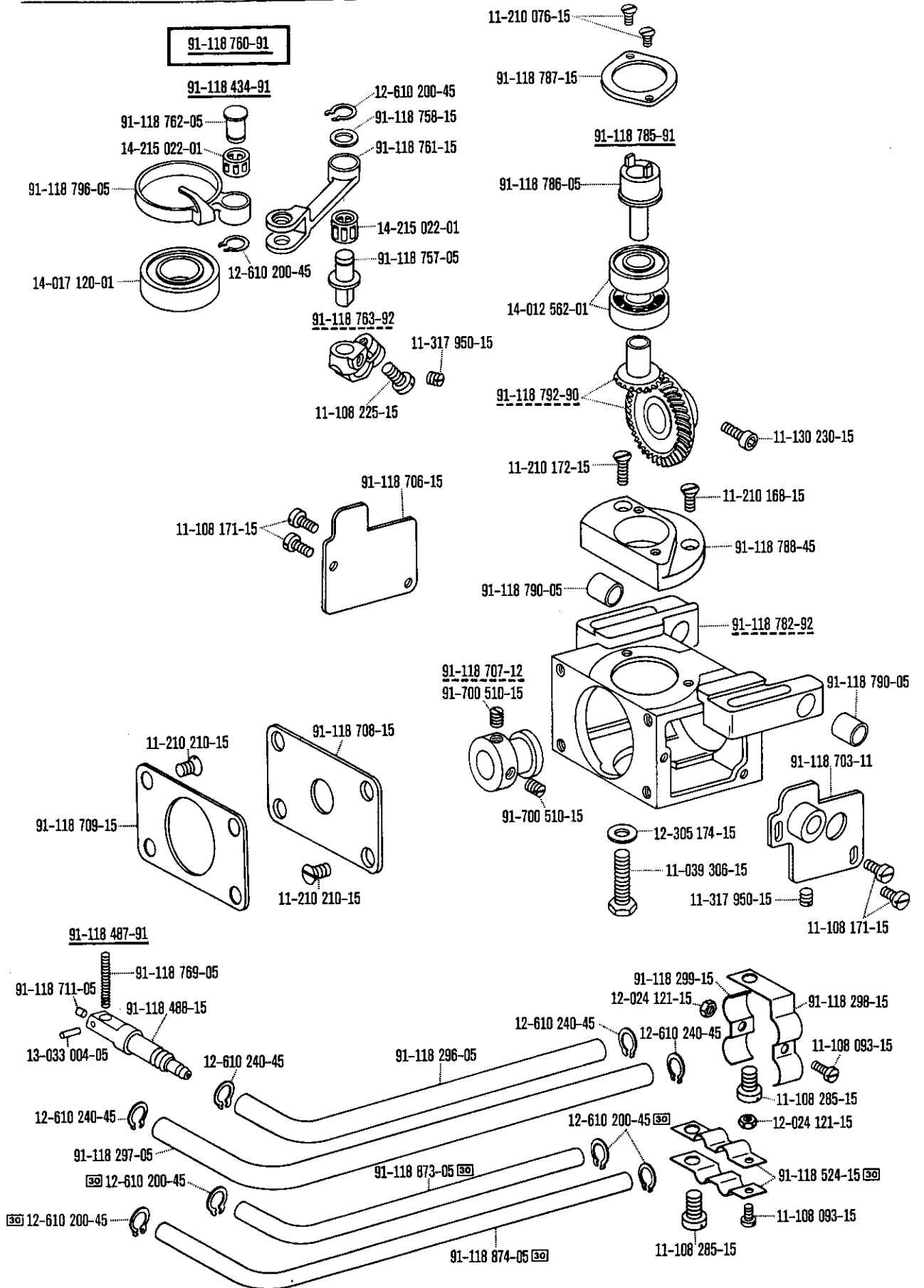

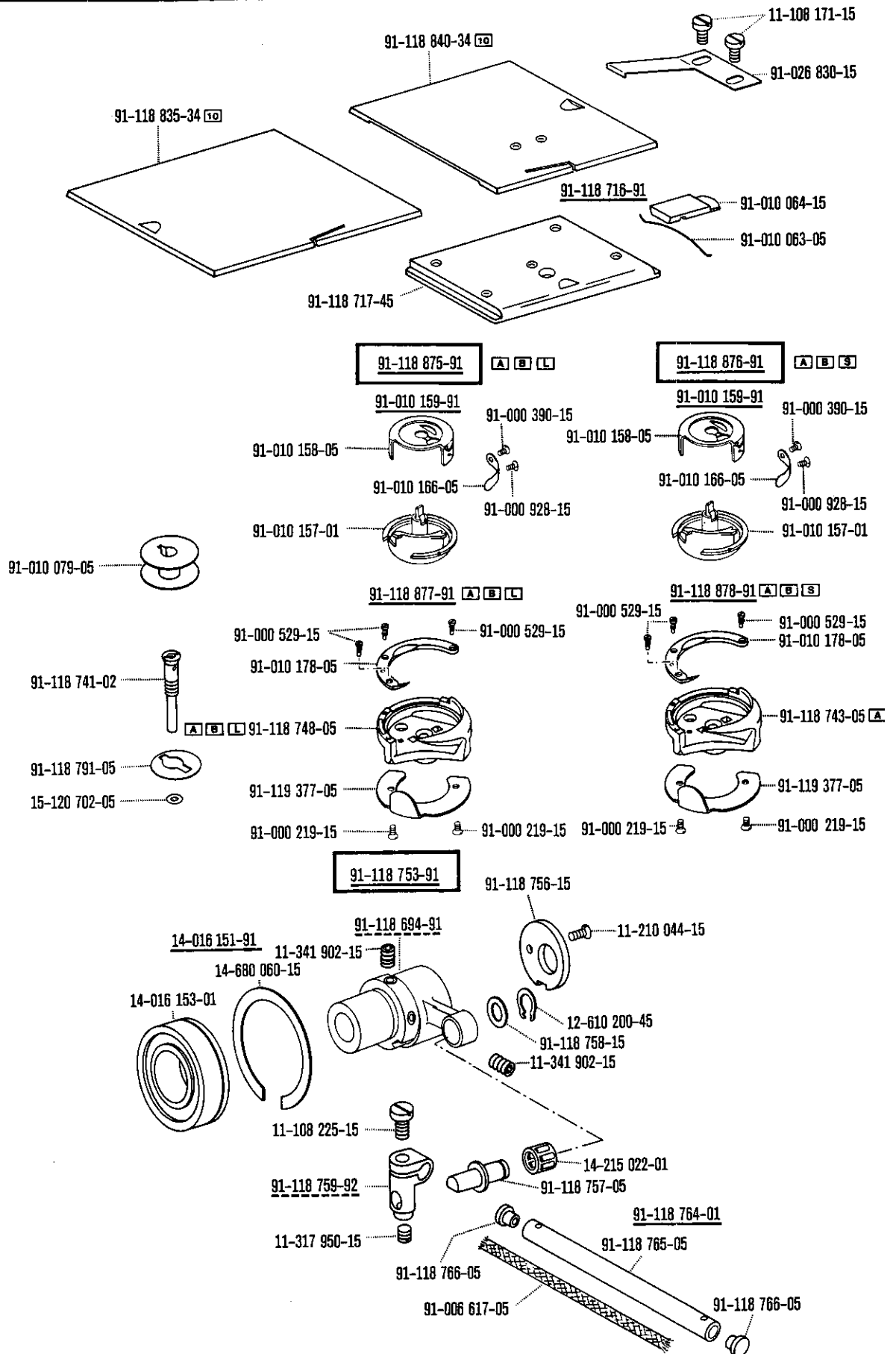

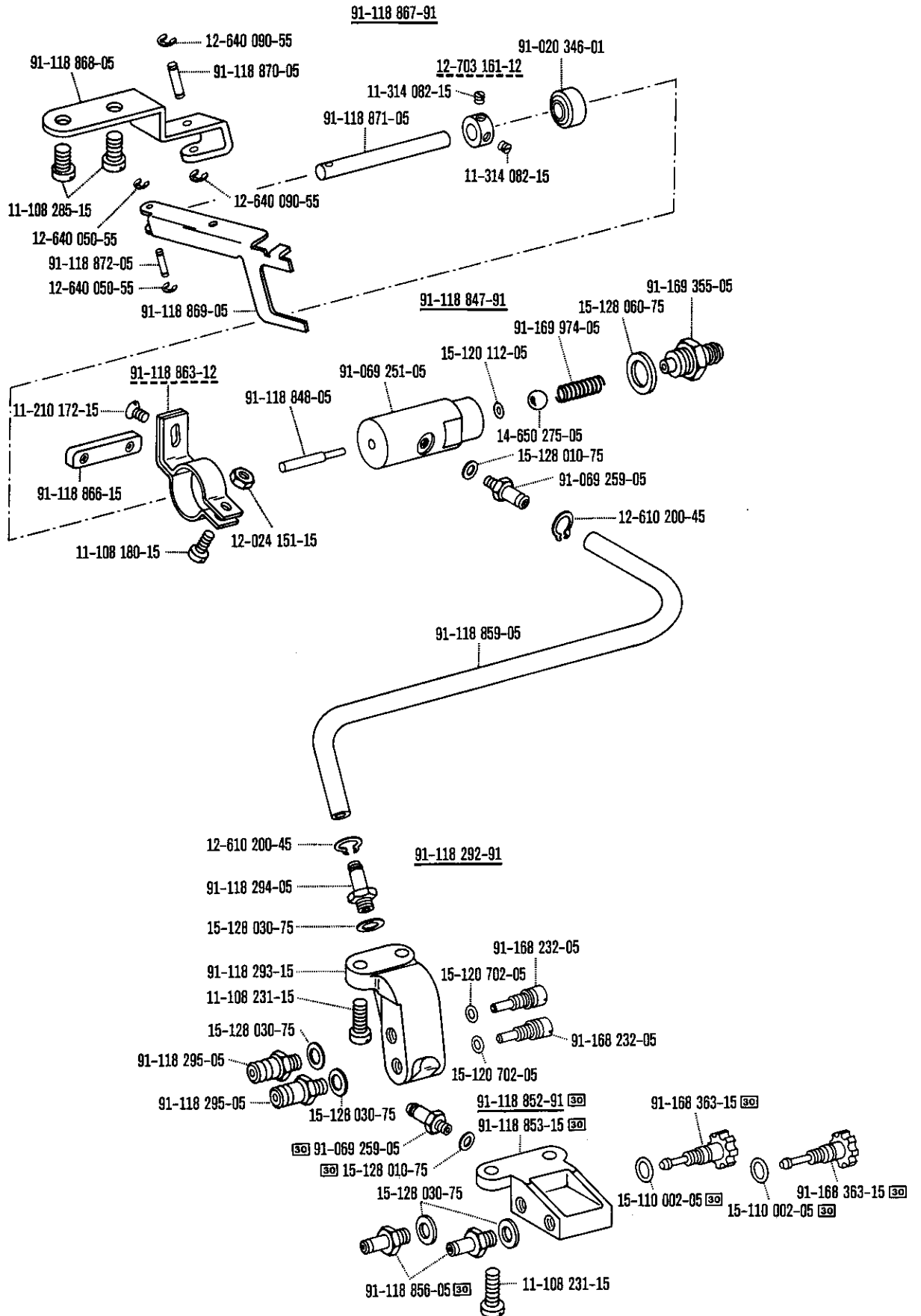

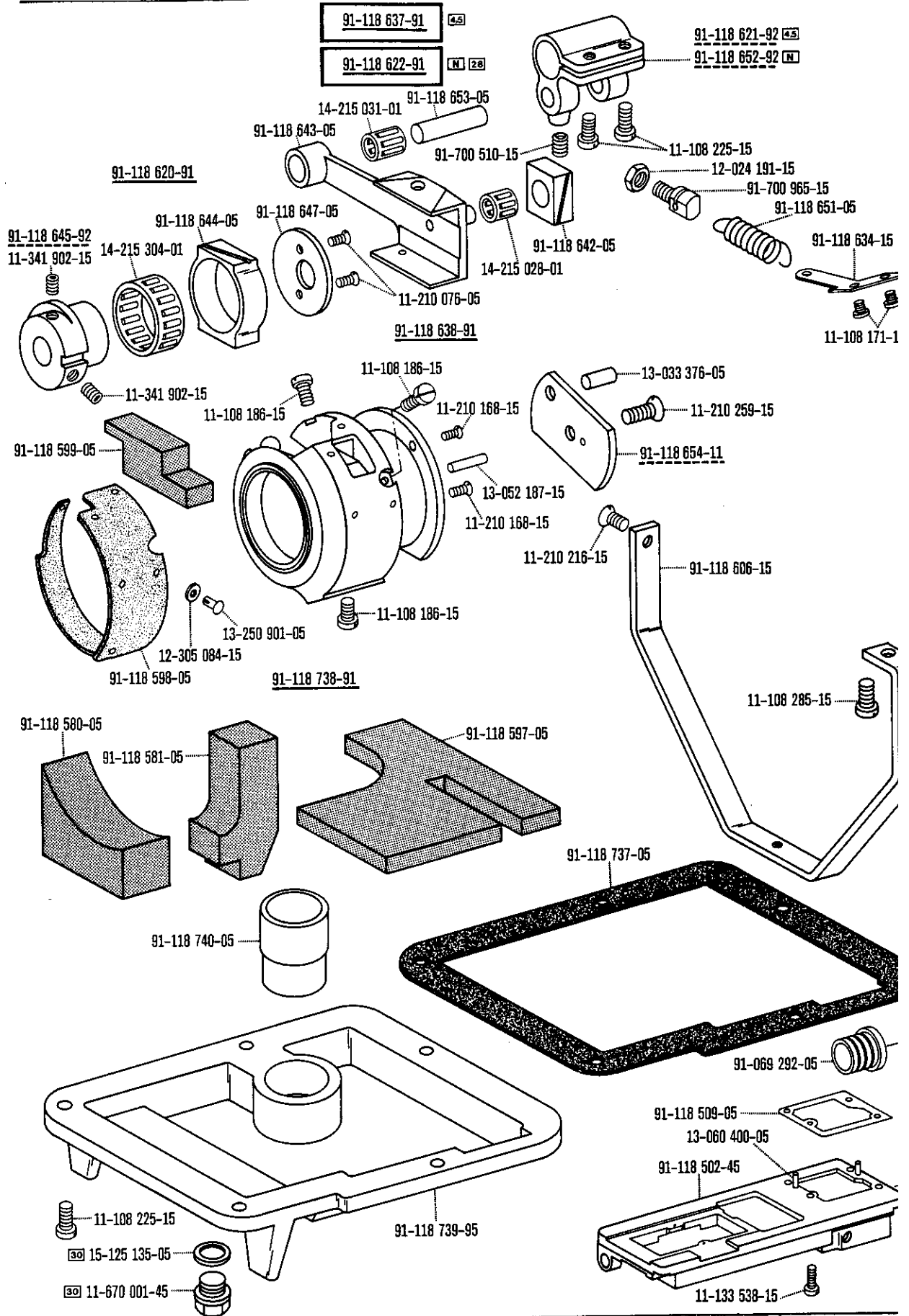

Zubehörteile
Accessory parts
Accessoires
Accesorios

91-171 412-91

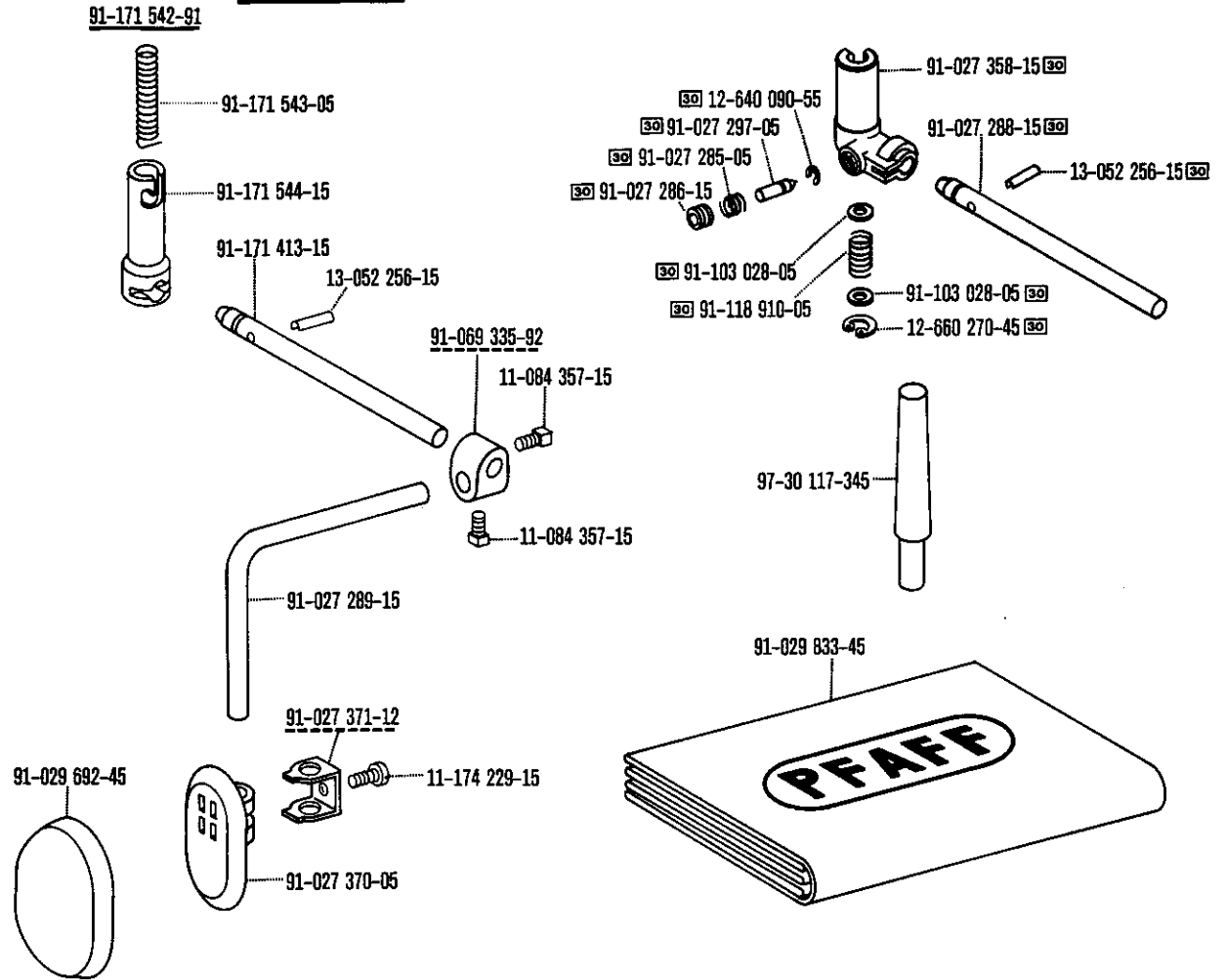

91-129 100-91

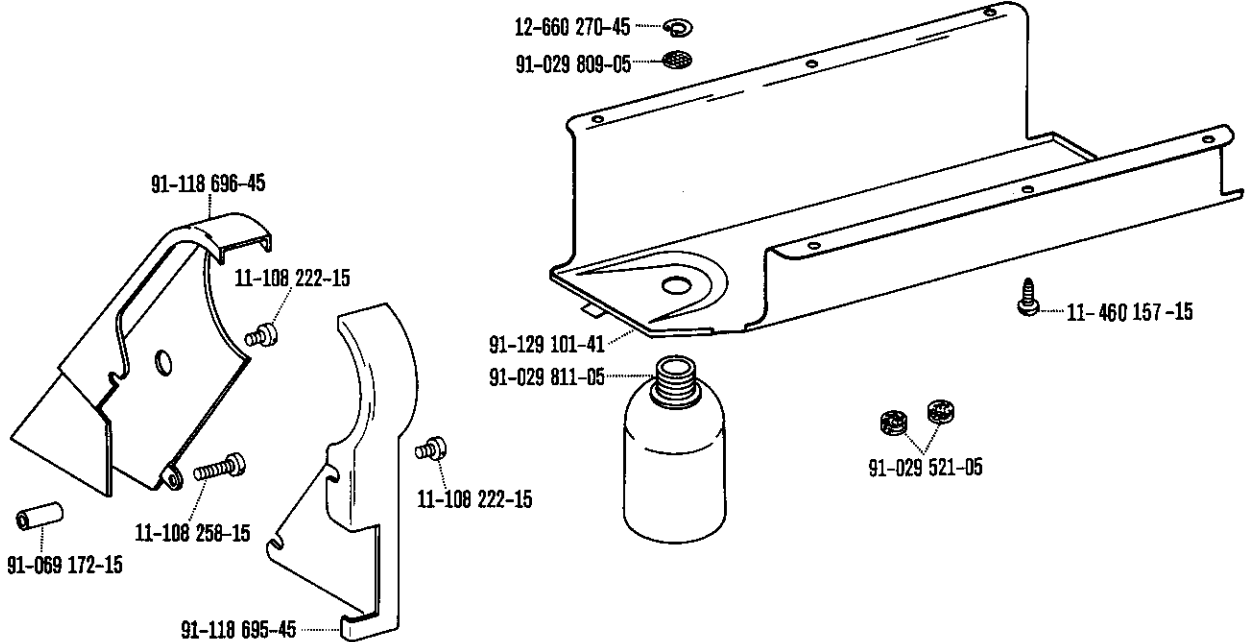

91-118 554-91

91-118 548-91

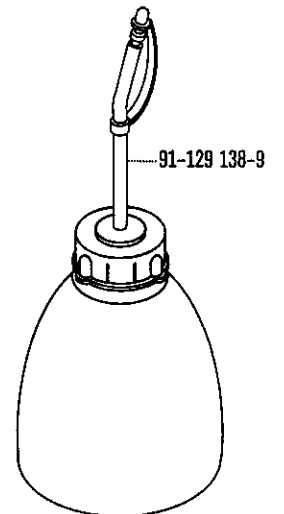
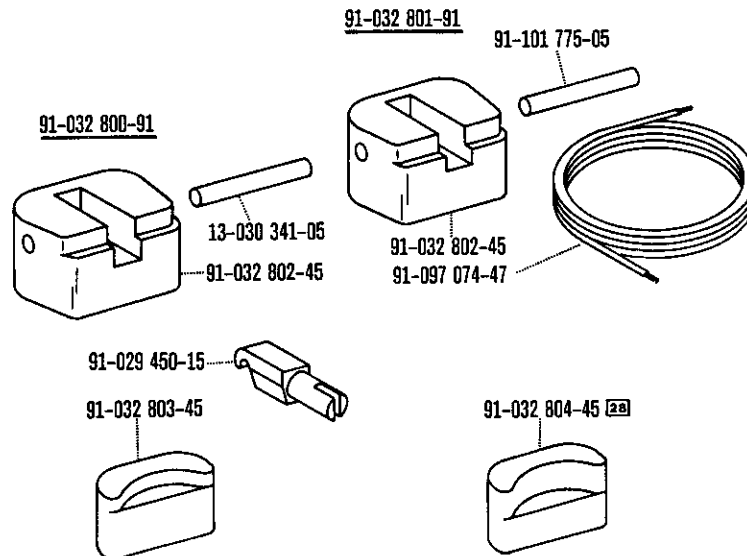
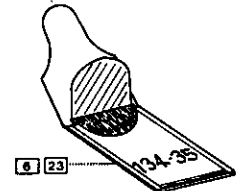
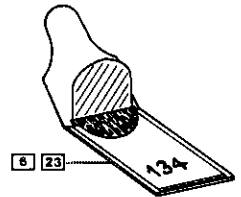
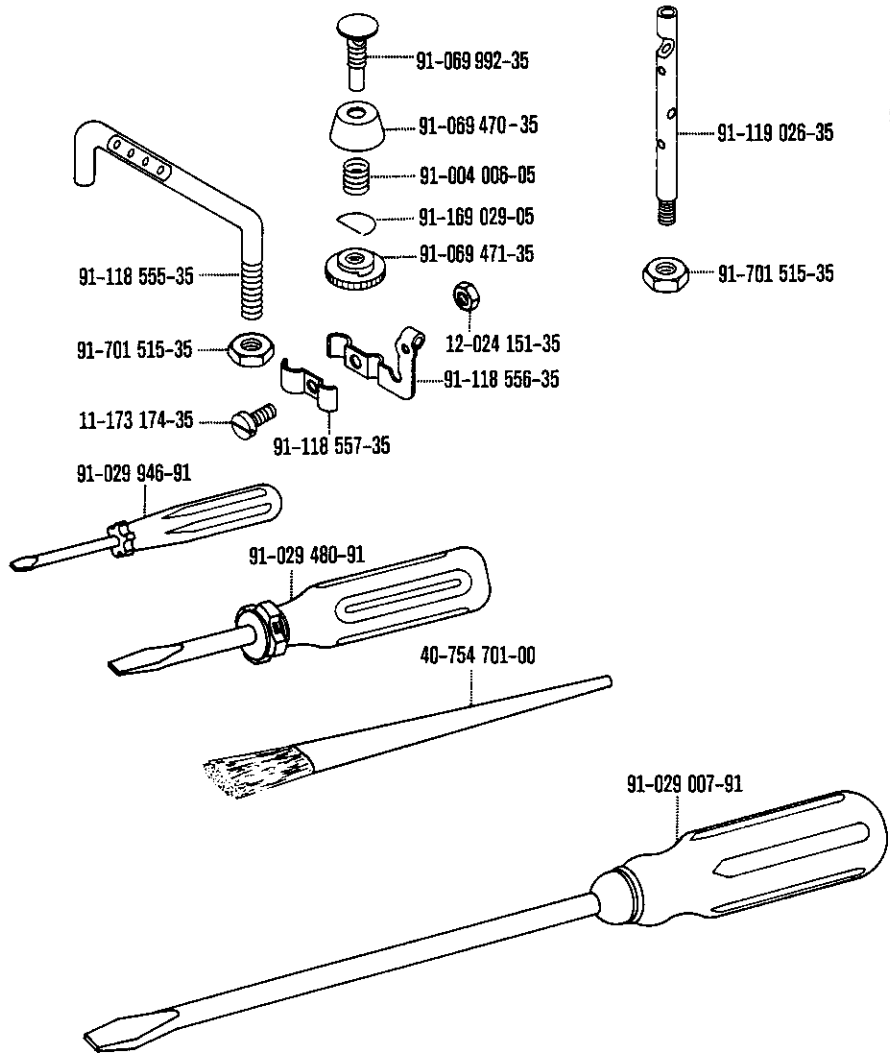

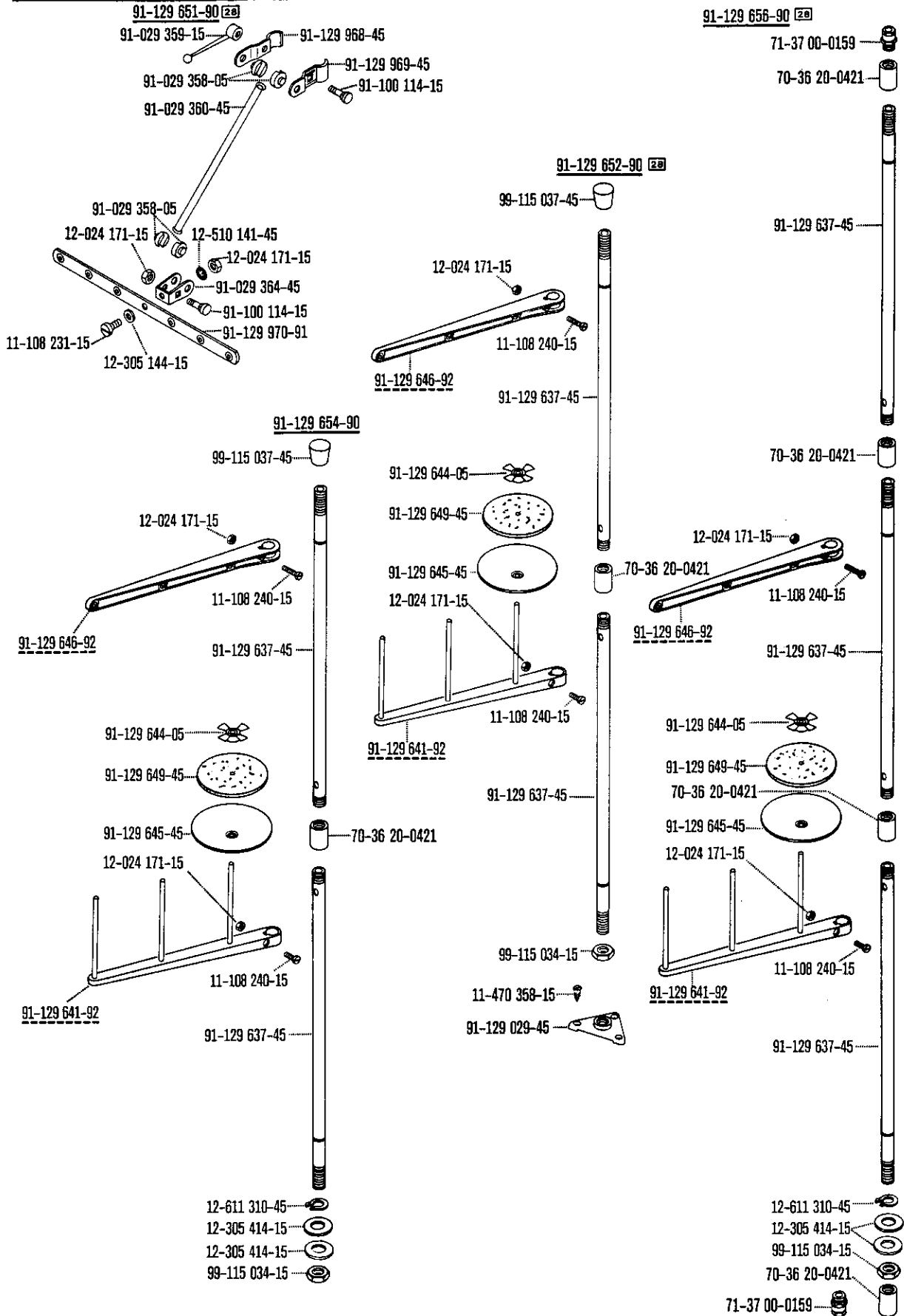

91-084 141-90 

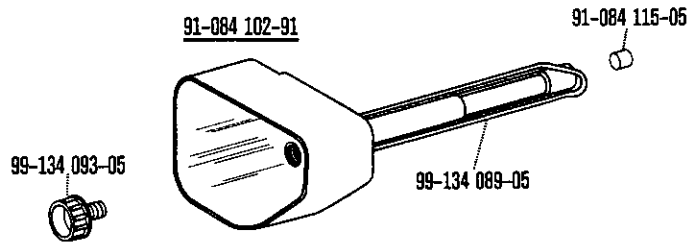
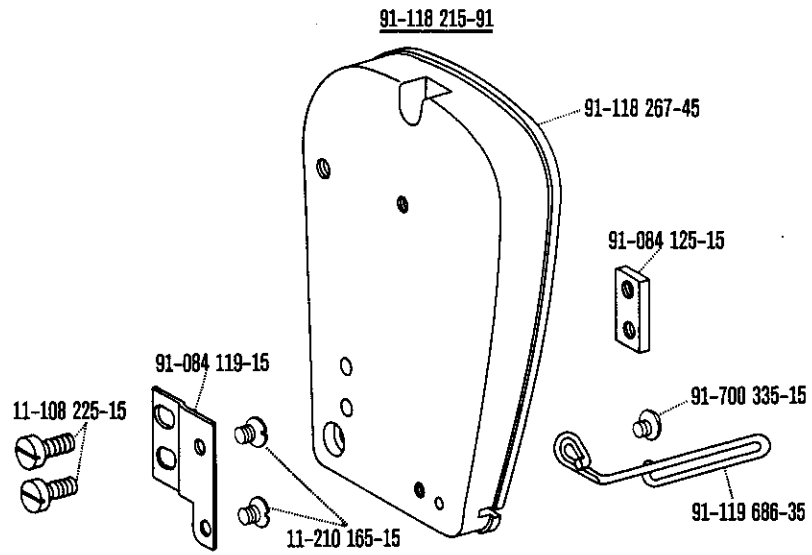

**Ergänzungsteile
der Pfaff 444-900/11**
(die sonstigen Teile
wie Pfaff 444)

**Complementary parts
for the Pfaff 444-900/11**
(for standard parts, please refer
to the Pfaff 444)

**Pièces complémentaires
de la Pfaff 444-900/11**
(les autres pièces sont les mêmes
que celles de la Pfaff 444)

**Piezas especiales
de la Pfaff 444-900/11**
(las demás piezas iguales que las
de la Pfaff 444)

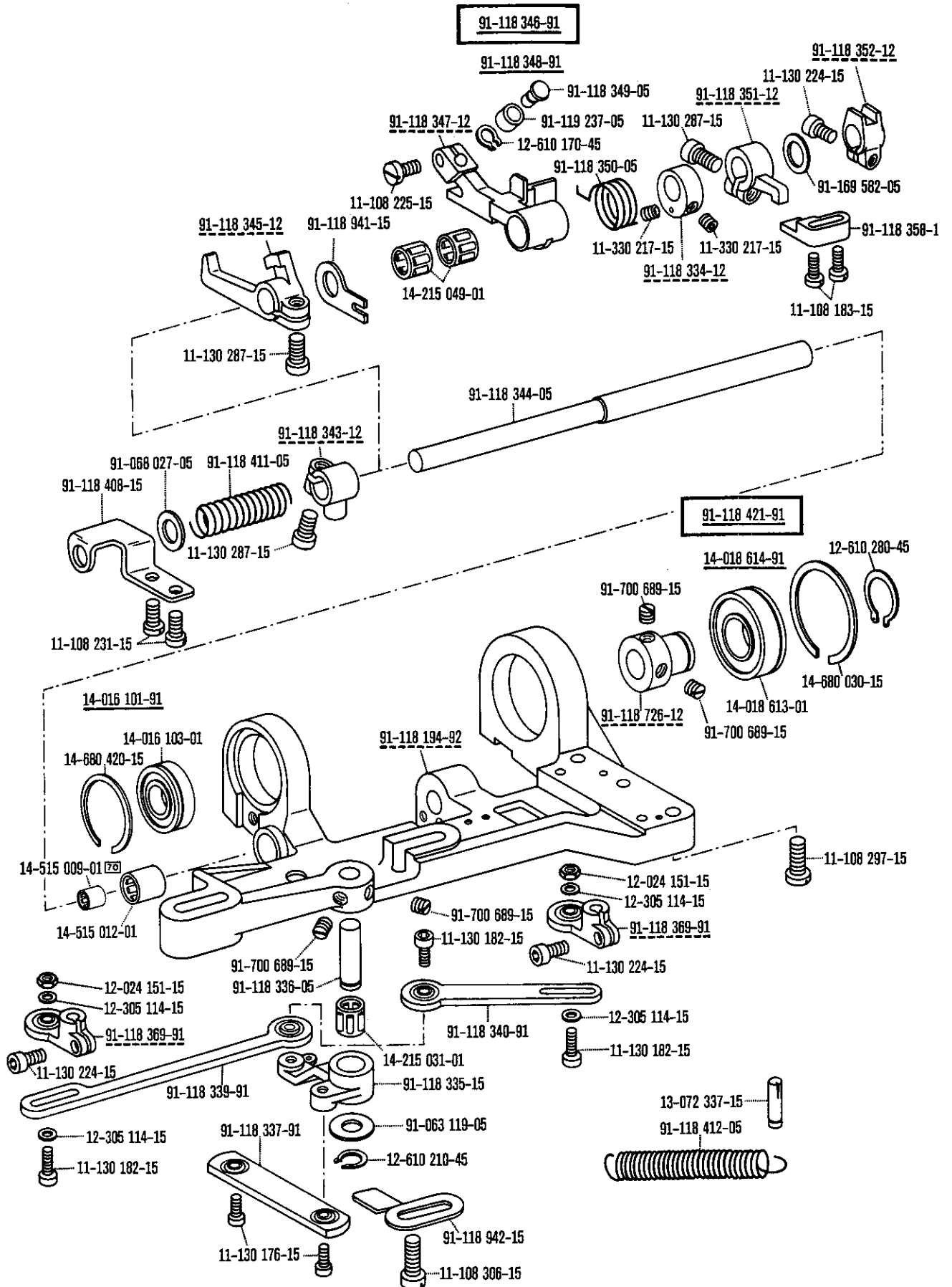

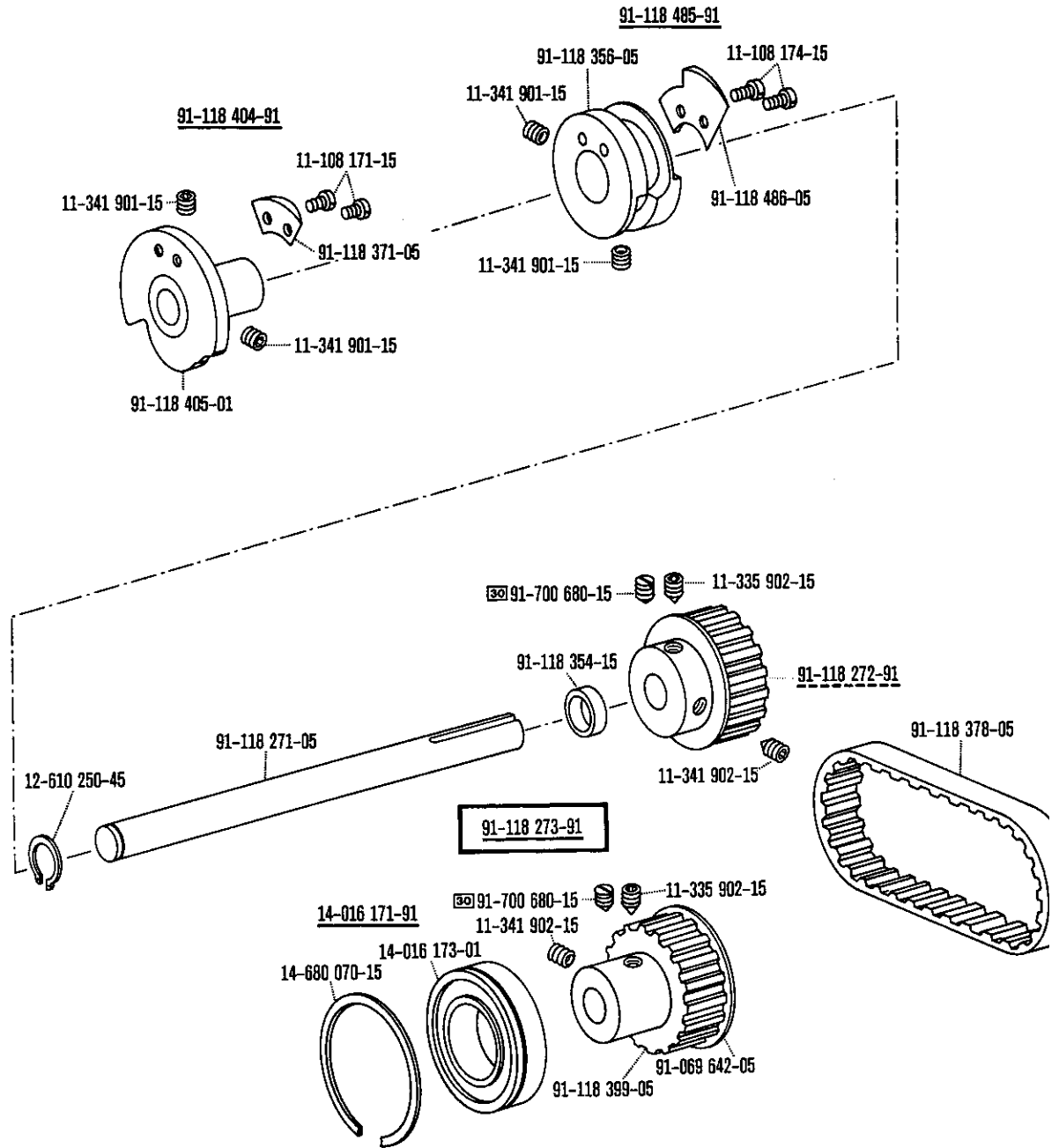

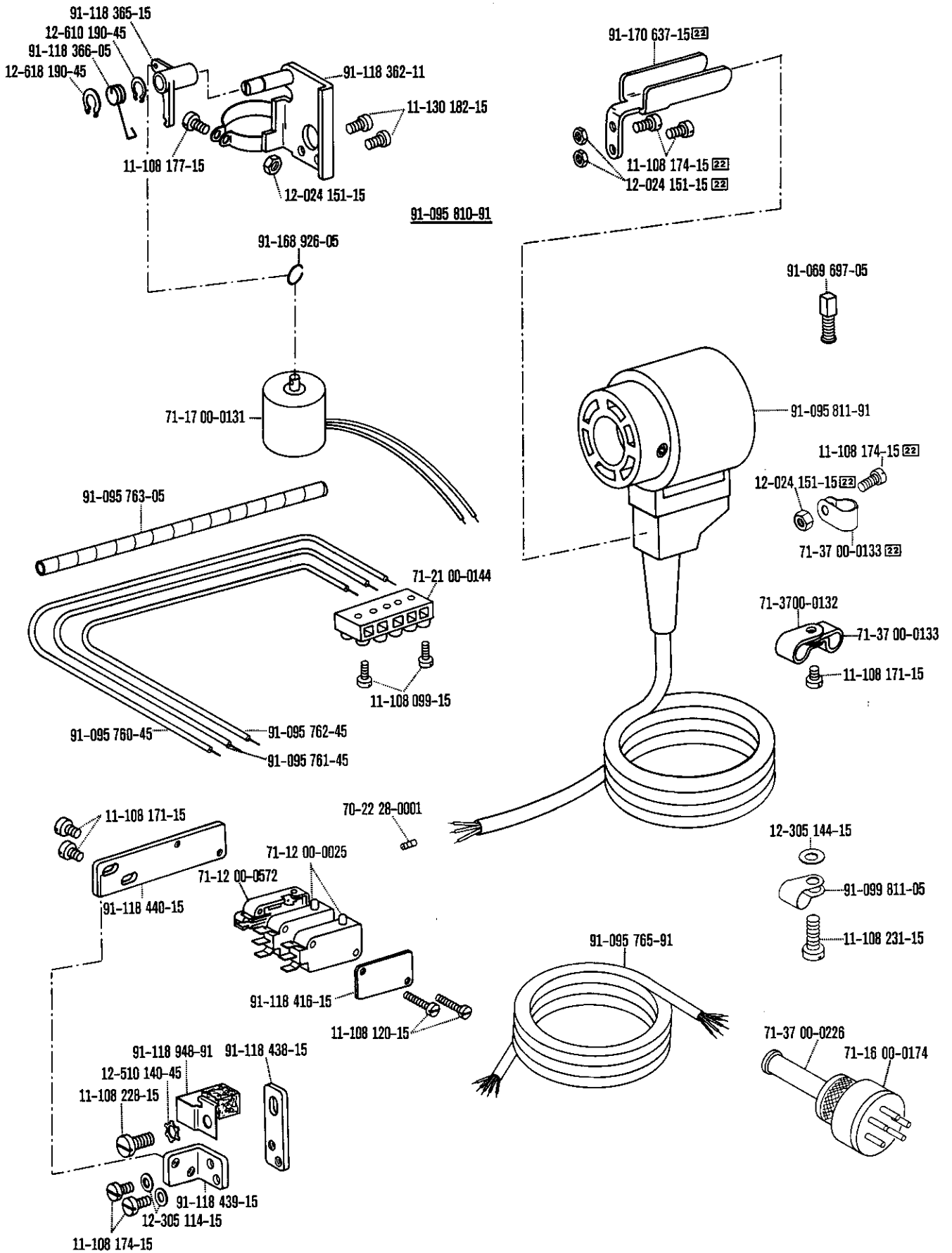

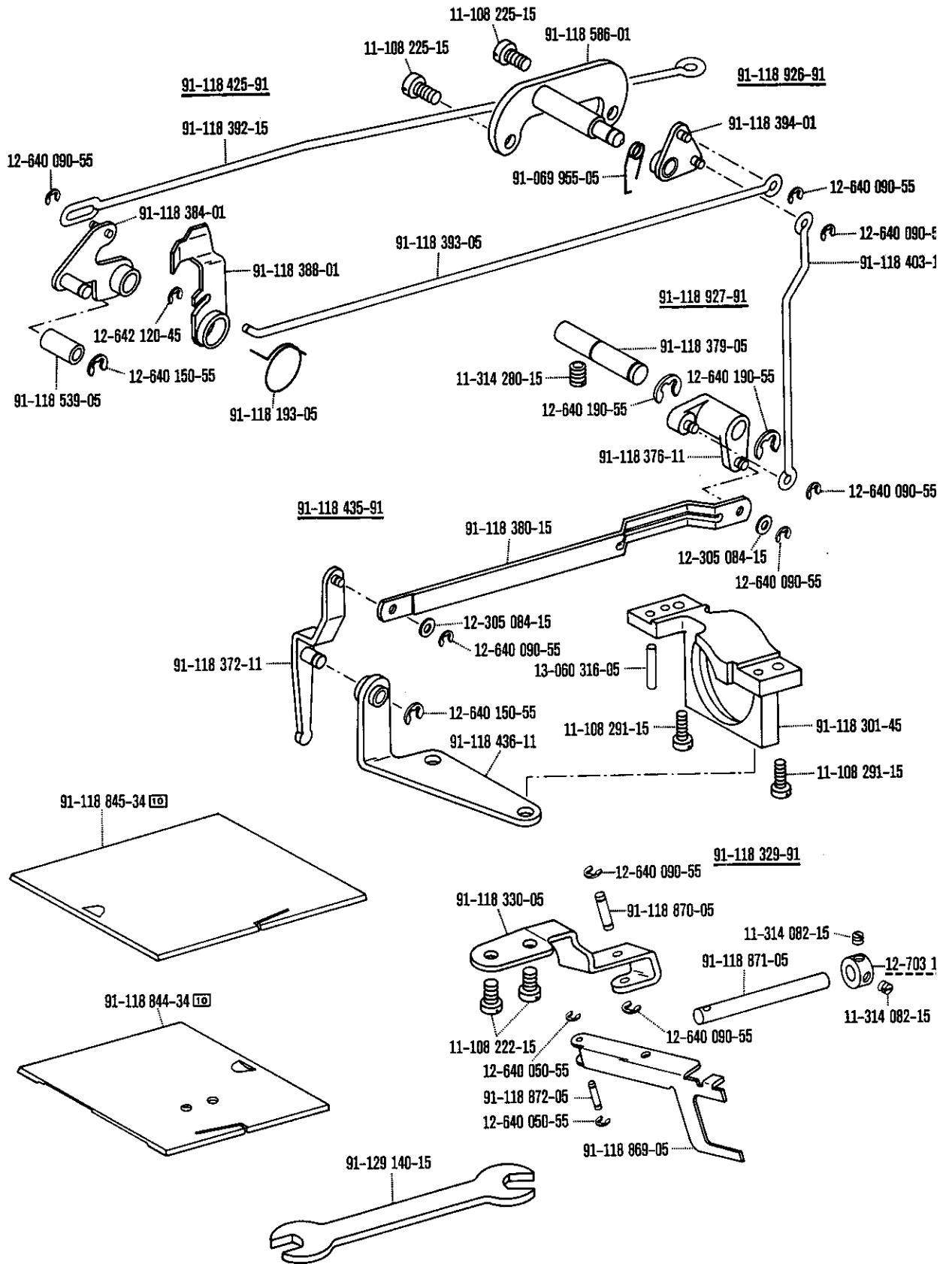

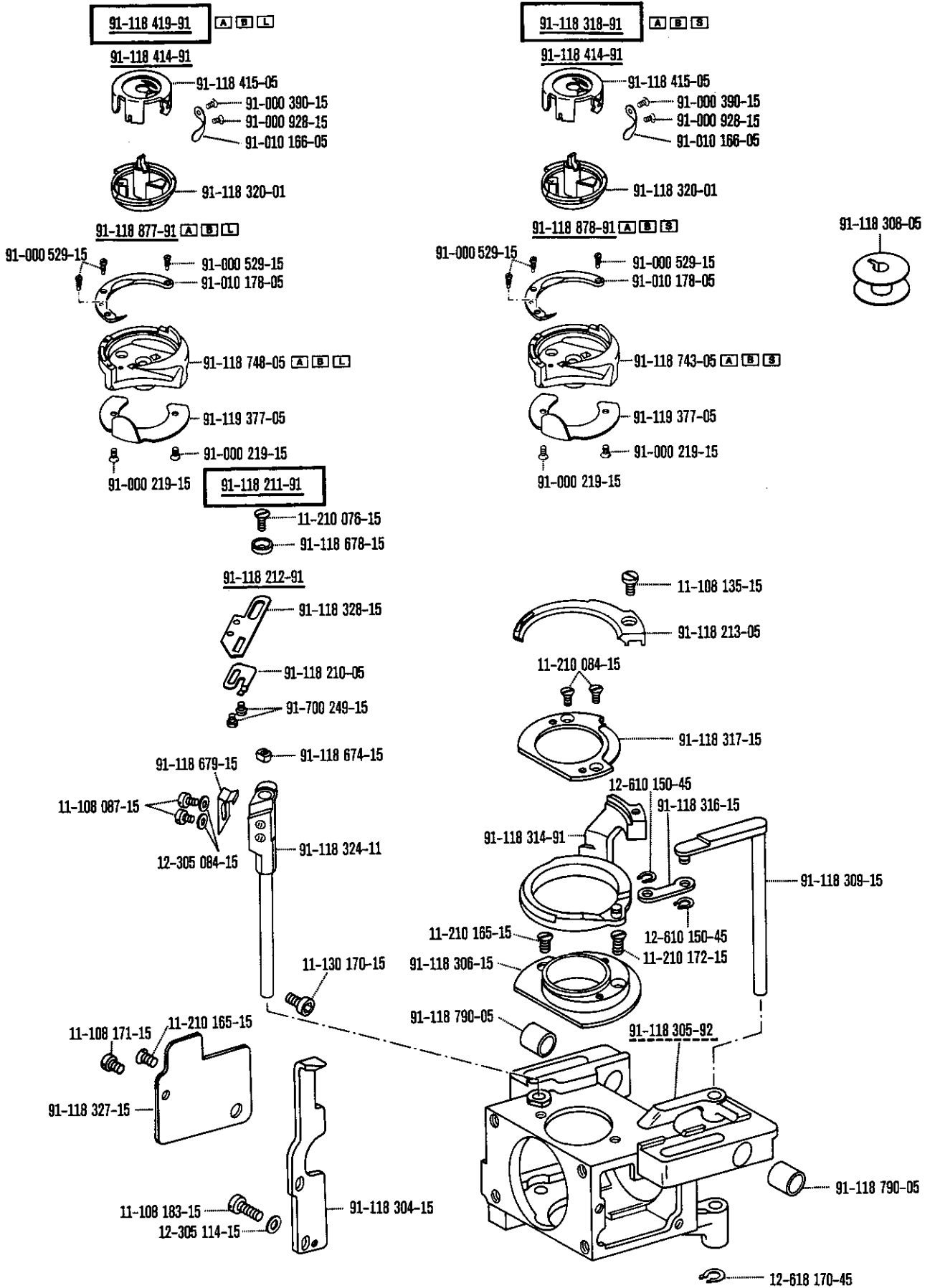

**Ergänzungsteile
der Pfaff 444-900/01³²**
(die sonstigen Teile
wie Pfaff 444-900/11)

**Complementary parts
for the Pfaff 444-900/01³²**
(for standard parts, please refer
to the Pfaff 444-900/11)

**Pièces complémentaires
de la Pfaff 444-900/01³²**
(les autres pièces sont les mêmes
que celles de la Pfaff 444-900/11)

**Piezas especiales
de la Pfaff 444-900/01³²**
(las demás piezas iguales que las
de la Pfaff 444-900/11)

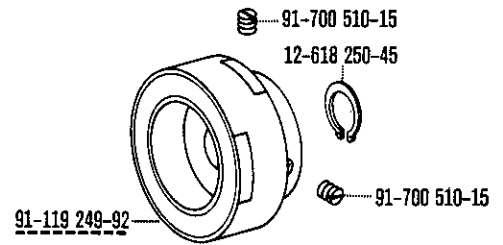
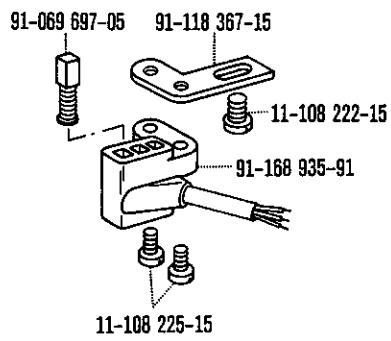

**Presserfußautomatik
-910/01**

(für Pfaff 444-900/11-913/04; 913/02)

**Automatic presser foot
lifter -910/01**

(for Pfaff 444-900/11-913/04; -913/02)

**Releveur automatique
du pied presseur -910/01**

(pour Pfaff 444-900/11-913/04; -913/02)

**Alzaprensatelas automático
-910/01**

(para la Pfaff 444-900/11-913/04; -913/02)

91-118 495-90 (-900/11-913/04)

91-118 497-90 (-913/02)

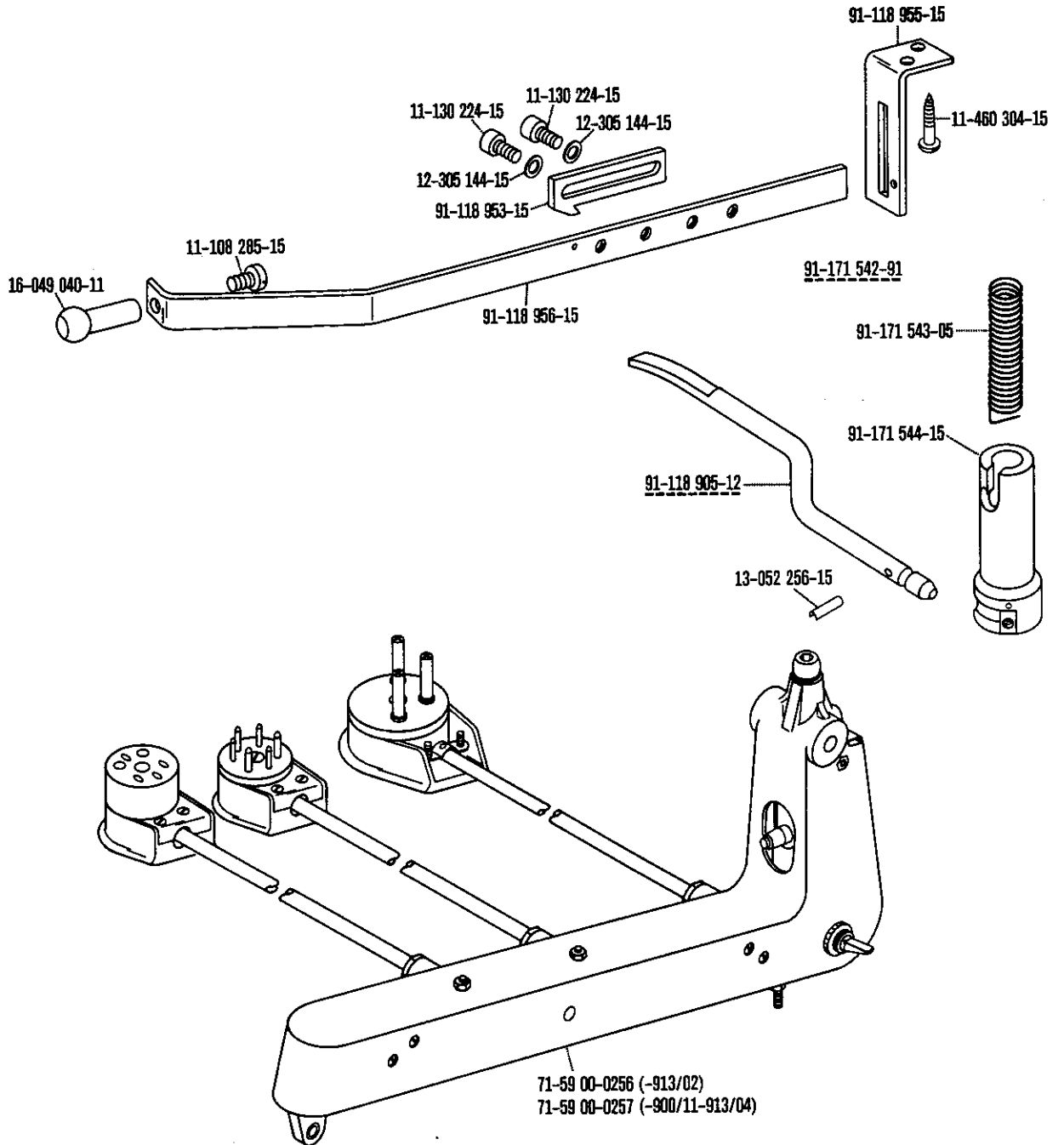

Nadelpositionier-Einrichtung

-913/01³² ; -913/02

(für Pfaff444 ohne -900)

-913/04

(für Pfaff444 mit -900)

Automatic needle positioner

-913/01³² ; -913/02

(for Pfaff444 without -900)

-913/04

(for Pfaff444 with -900)

Dispositif de positionnement de l'aiguille

-913/01³² ; -913/02

(pour Pfaff444 sans -900)

-913/04

(pour Pfaff444 avec -900)

Dispositivo para posicionar la aguja

-913/01³² ; -913/02

(para Pfaff444 sin -900)

-913/04

(para Pfaff444 con -900)

91-118 583-90

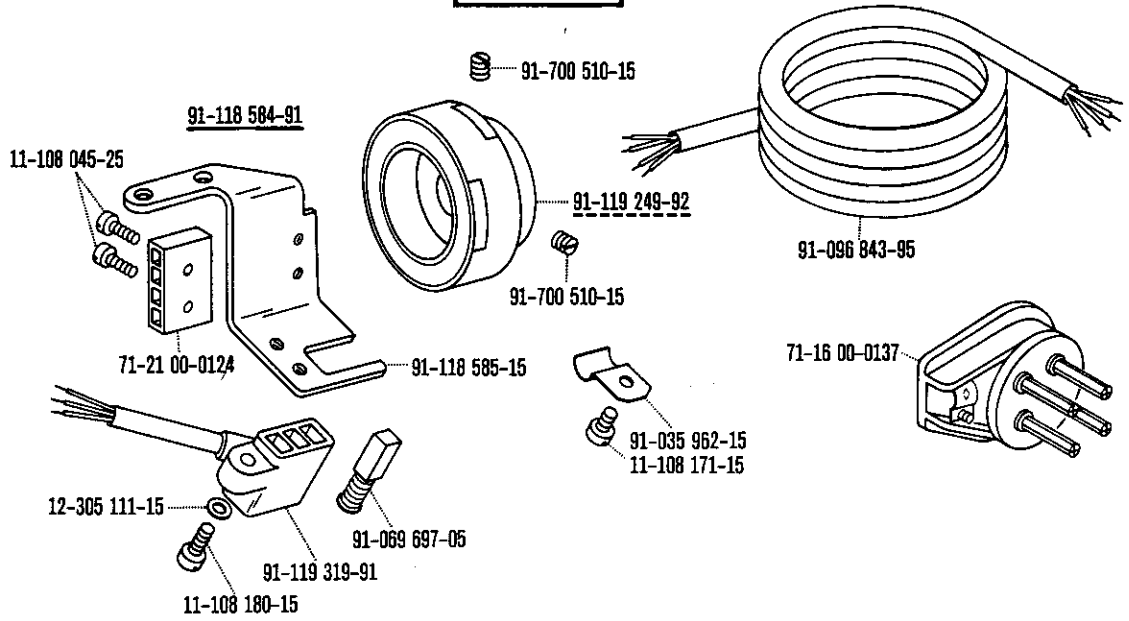

Pfaff -913/02

91-118 285-90

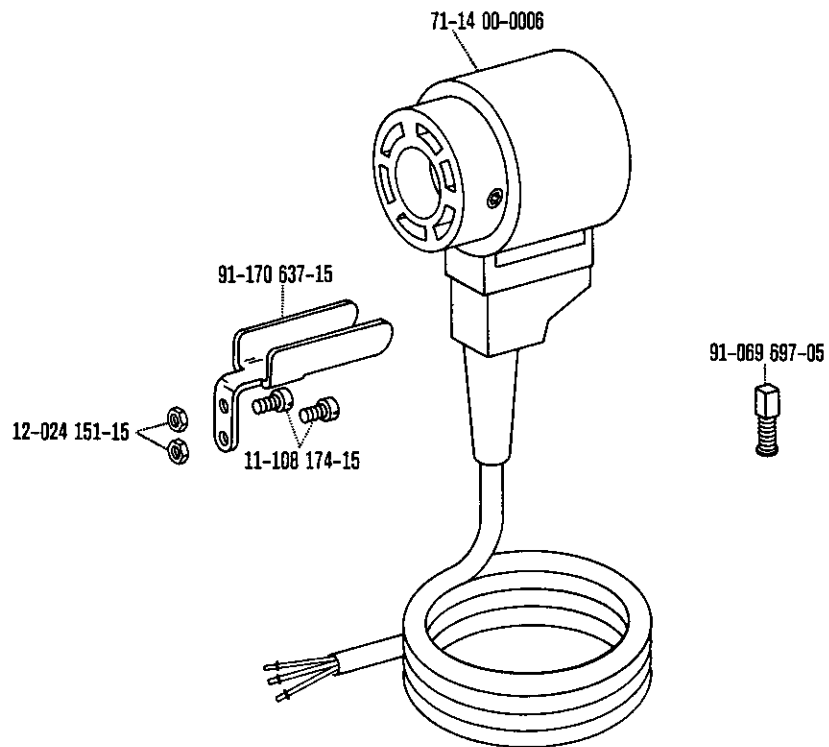

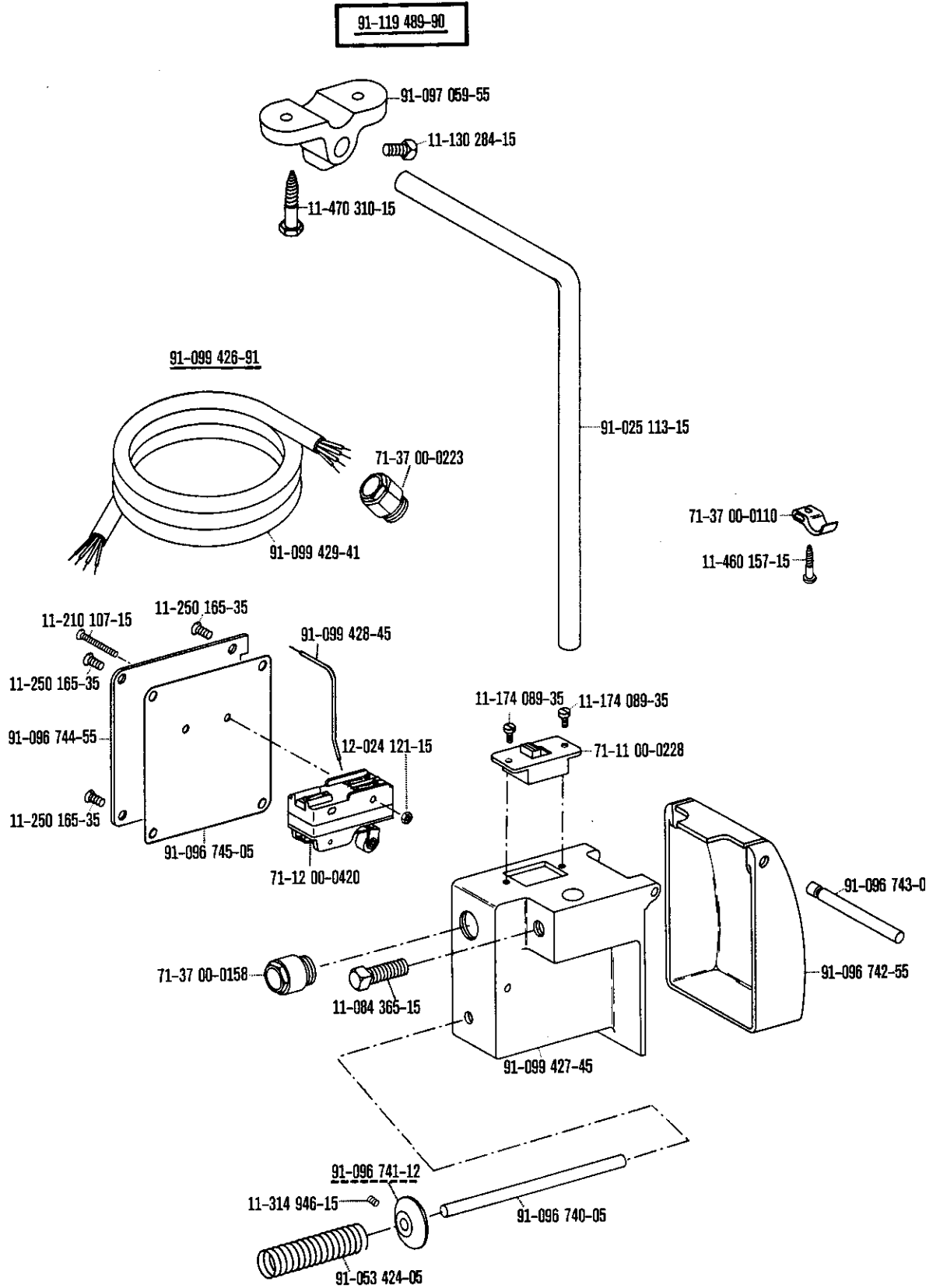

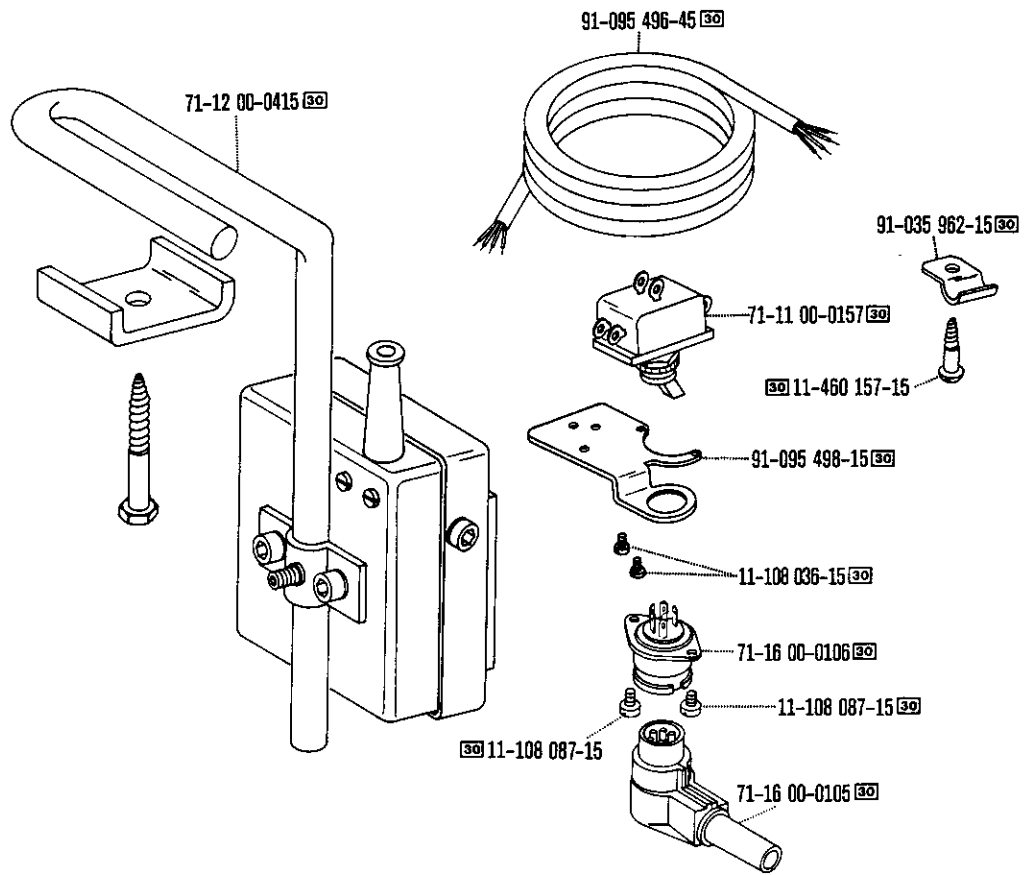

**Ergänzungsteile
der Pfaff 444-944/01**
(die sonstigen Teile
wie Pfaff 444)

**Complementary parts
for the Pfaff 444-944/01**
(for standard parts, please refer
to the Pfaff 444)

**Pièces complémentaires
de la Pfaff 444-944/01**
(les autres pièces sont les mêmes
que celles de la Pfaff 444)

**Piezas especiales
de la Pfaff 444-944/01**
(las demás piezas iguales que las
de la Pfaff 444)

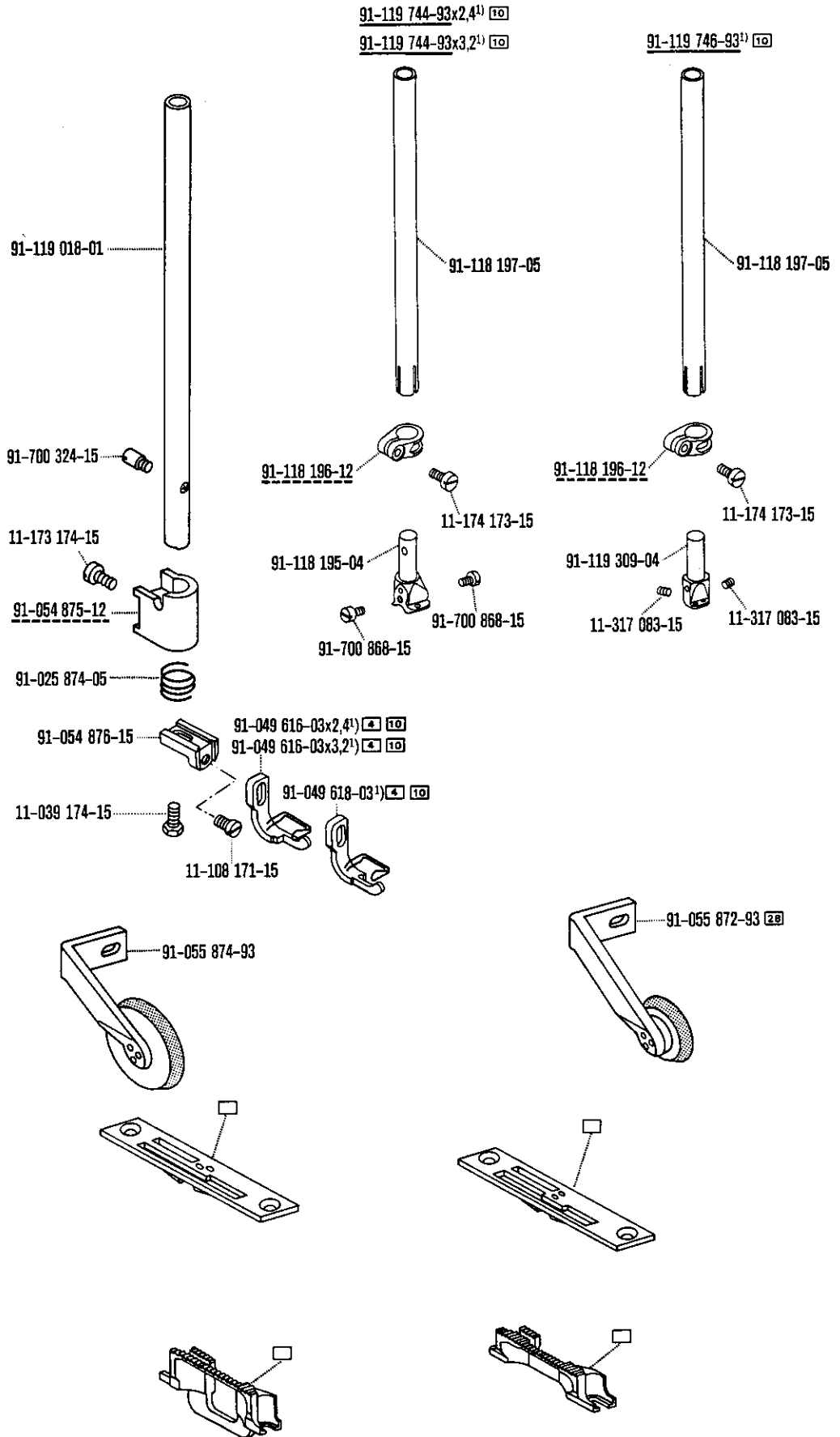

Nadelabstandstabelle

Needle gauge chart

Tableau des écartements
d'aiguilles

Tabla de distancias entre agujas

Nadelabstandstabelle · Needle gauge chart · Tableau des écartements d'aiguilles · Tabla de distancias 1.73

















Teilebenennung	Teilenummer	Ausführung	Nadeldiagonalabstand in mm	Nadelabstand ²⁾ in mm	
Part name	Part number	Model	Diagonal needle distance in mm	Needle gauge ²⁾ in mm	
Désignations des pièces	Numéros des pièces	Versions	Ecartement diagonal des aiguilles en mm	Ecartement des aiguilles ²⁾ en mm	
Denominación de las piezas	Nº de las piezas	Tipo	Distancia diagonal entre agujas en mm	Distancia entre agujas ²⁾ en mm	
Nadelstange Needle bar Barre à aiguille Barra de aguja	91-119 744-93 ¹⁰ x2,4		2,4	0,8 1,0 1,2 1,4 1,6 1,8 2,0 2,2	
	91-119 744-93 ¹⁰ x3,2		3,2	1,2 1,4 1,6 1,8 2,0 2,2	
	91-118 198-93 ¹⁰				2,4 3,2 4,0 4,8
					5,2 6,0 6,4 7,2
					8,0 9,2 10,0 11,2
12,0 13,2 14,0 15,2					
16,0 17,2 18,0 20,0					
91-119 746-93 ¹⁰				2,4 3,2 4,0 4,8 5,2 6,0	
Stoffschieber Feed dog Griffe Transportador	91-047 366-04 ⁴ ¹⁰	A; B		4,8 5,2 6,0 6,4 7,2 8,0 9,2 10,0 11,2 12,0 13,2 14,0 15,2 16,0 17,2 18,0 20,0	
	91-047 568-04 ⁴ ¹⁰	A	2,4	0,8 1,0 1,2 1,4 1,6 1,8 2,0 2,2	
	91-047 568-04 ⁴ ¹⁰	B	3,2	1,2 1,4 1,6 1,8 2,0 2,2	
	91-047 569-04 ⁴ ¹⁰	A; B		2,4 3,2 4,0 4,8 5,2 6,0	
	91-047 863-04 ⁴ ¹⁰	A	2,4	0,8 1,0 1,2 1,4 1,6 1,8 2,0 2,2	
	91-047 863-04 ⁴ ¹⁰	B	3,2	1,2 1,4 1,6 1,8 2,0 2,2	
	91-047 864-04 ⁴ ¹⁰	A; B		2,4 3,2 4,0	

Nadelabstandstabelle · Needle gauge chart · Tableau des écartements d'aiguilles · Tabla de distancias 1.























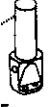

Teilebenennung	Teilenummer	Ausführung	Nadeldiagonalabstand in mm	Nadelabstand ²⁾ in mm			
Part name	Part number	Model	Diagonal needle distance in mm	Needle gauge ²⁾ in mm			
Désignations des pièces	Numéros des pièces	Versions	Ecartement diagonal des aiguilles en mm	Ecartement des aiguille en mm			
Denominación de las piezas	N° de las piezas	Tipo	Distancia diagonal entre agujas en mm	Distancia entre agujas en mm			
	91-058 101-04 [4] [10]	A	2,4	0,8 1,6	1,0 1,8	1,2 2,0	1,4 2,2
	91-058 101-04 [4] [10]	B	3,2	1,2 2,0	1,4 2,2	1,6	1,8
	91-058 102-04 [4] [10]	A; B		2,4 5,2	3,2 6,0	4,0	4,8
	91-058 110-04 [4] [10]	A	2,4	0,8 1,6	1,0 1,8	1,2 2,0	1,4 2,2
	91-058 110-04 [4] [10]	B	3,2	1,2 2,0	1,4 2,2	1,6	1,8
	91-058 111-04 [4] [10]	A; B		2,4 5,2	3,2 6,0	4,0	4,8
Stichplatte	91-058 443-04 [4] [10]	A; B		4,8 7,2 11,2 15,2 20,0	5,2 8,0 12,0 16,0	6,0 9,2 13,2 17,2	6,4 10,0 14,0 18,0
Needle plate							
Plaque à aiguille							
Placa de aguja	91-058 444-04 [4] [10]	A; B		4,8 7,2 11,2 15,2 20,0	5,2 8,0 12,0 16,0	6,0 9,2 13,2 17,2	6,4 10,0 14,0 18,0
	91-058 559-04 [4] [10]	A	2,4	0,8 1,6	1,0 1,8	1,2 2,0	1,4 2,2
	91-058 559-04 [4] [10]	B	3,2	1,2 2,0	1,4 2,2	1,6	1,8
	91-058 560-04 [4] [10]	A; B		2,4	3,2	4,0	
	91-058 561-04 [4] [10]	A	2,4	0,8 1,6	1,0 1,8	1,2 2,0	1,4 2,2
	91-058 561-04 [4] [10]	B	3,2	1,2 2,0	1,4 2,2	1,6	1,8
	91-058 562-04 [4] [10]	A; B		2,4	3,2	4,0	













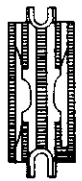

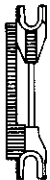

00-000 000-00 [4] [10] siehe Erläuterungen Seite 6
see explanations on page 7
voir légende page 8



²⁾ Standardnadelabstände siehe Tabellen Seite 10
For standard needle gauges see tables on page 10
Ecartements d'aiguilles standards, cf. tableaux page 10

Teilebenennung	Teilenummer	Ausführung	Nadeldiagonalabstand in mm	Nadelabstand ²⁾ in mm
Part name	Part number	Model	Diagonal needle distance in mm	Needle gauge ²⁾ in mm
Désignations des pièces	Numéros des pièces	Versions	Ecartement diagonal des aiguilles en mm	Ecartement des aiguilles ²⁾ en mm
Denominación de las piezas	Nº de las piezas	Tipo	Distancia diagonal entre agujas en mm	Distancia entre agujas ²⁾ en mm
	91-055 711-03  	A; B		4,8 5,2 6,0 6,4 7,2 8,0 9,2 10,0 11,2 12,0 13,2 14,0
	91-055 713-03  			15,2 16,0 17,2 18,0 20,0
Nähfuß	91-055 980-03  	A	2,4	0,8 1,0 1,2 1,4 1,6 1,8 2,0 2,2
Presser foot				
Pied presseur	91-055 980-03  	B	3,2	1,2 1,4 1,6 1,8 2,0 2,2
Pie prensatelas				
	91-055 980-03  	A; B		2,4 3,2 4,0
	91-049 616-03  	A	2,4	0,8 1,0 1,2 1,4 1,6 1,8 2,0 2,2
Drückerfuß	91-049 616-03  	B	3,2	1,2 1,4 1,6 1,8 2,0 2,2
Work retainer				
Pied de maintien	91-049 618-03  	A; B		2,4 3,2 4,0 4,8 5,2 6,0
Pie de retención				



Nähwerkzeuge
Organization parts
Organes de couture
Elementos de costura



<p>91-118 198-93¹⁾ </p>  <p>91-118 197-05</p>  <p>91-118 196-12</p>  <p>11-174 173-15</p>  <p> 91-710 004-04</p>  <p>11-174 086-15</p>  <p>11-174 086-15</p> <p>-6/01; -6/01 -900/11</p>	<p>91-119 746-93¹⁾ </p>  <p>91-118 197-05</p>  <p>91-118 196-12</p>  <p>11-174 173-15</p>  <p> 91-119 309-04</p>  <p>11-317 083-15</p>  <p>11-317 083-15</p> <p>-944/01; -944/01 -900/11</p>	<p>91-119 744-93x2,4¹⁾ </p> <p>91-119 744-93x3,2¹⁾ </p>  <p>91-118 197-05</p>  <p>91-118 196-12</p>  <p>11-174 173-15</p>  <p> 91-118 195-04</p>  <p>91-700 868-15</p>  <p>91-700 868-15</p> <p>-6/01; -6/01 -900/11 -944/01; -944/01 -900/11</p>
---	---	--

<p>91-047 366-04¹⁾  </p>  <p>-6/01; -6/01 -900/11</p>	<p>91-047 568-04x2,4¹⁾   91-047 568-04x3,2¹⁾  </p>  <p>-944/01; -944/01 -900/11</p>	<p>91-047 569-04¹⁾  </p>  <p>944/01; -944/01 -900/11</p>
<p>91-047 863-04x2,4¹⁾  </p>  <p>-6/01; -6/01 -900/11</p>	<p>91-047 864-04¹⁾  </p>  <p>-6/01; -6/01 -900/11</p>	

00-000 000-00   siehe Erläuterungen Seite 6
 see explanations on page 7
 voir légende page 8



¹⁾ siehe Nadelabstandstabelle Seite 59
 see needle gauge chart on page 59
 voir tableau des écartements d'aiguilles à la page 59

91-058 101-04x2,4¹⁾  

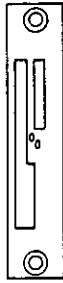
91-058 101-04x3,2¹⁾  





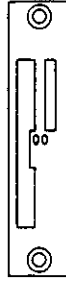

-944/01

91-058 102-04¹⁾  





-944/01

91-058 110-04x2,4¹⁾  

91-058 110-04x3,2¹⁾  





-944/01-900/11

91-058 111-04¹⁾  





-944/01-900/11

91-058 443-04¹⁾  







-6/01

91-058 444-04¹⁾  



-6/01-900/11

91-058 559-04x2,4¹⁾  

91-058 559-04x3,2¹⁾  

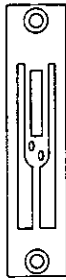



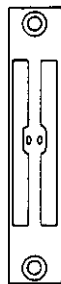

-6/01

91-058 560-04¹⁾  





-6/01

91-058 561-04x2,4¹⁾  

91-058 561-04x3,2¹⁾  















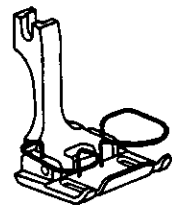

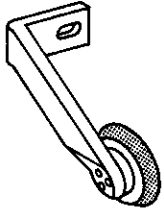
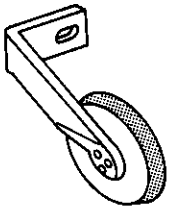

-6/01-900/11

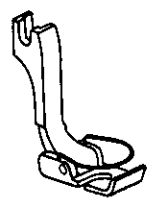
91-058 562-04¹⁾  

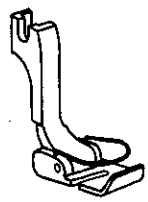









-6/01-900/11

<p>91-055 711-03¹⁾  </p>  <p>-6/01; -6/01-900/11</p>	<p>91-055 713-03¹⁾  </p>  <p>-6/01; -6/01-900/11</p>	<p>91-055 872-93 </p>  <p>-944/01; -944/01-900/11</p>
<p>91-055 874-93</p>  <p>-944/01; -944/01-900/11</p>	<p>91-055 980-03x2,4¹⁾   91-055 980-03x3,2¹⁾  </p>  <p>-6/01; -6/01-900/11</p>	<p>91-055 980-03¹⁾  </p>  <p>-6/01; -6/01-900/11</p>

00-000 000-00    siehe Erläuterungen Seite 6
 see explanations on page 7
 voir légende page 8

¹⁾ siehe Nadelabstandstabelle Seite 59
 see needle gauge chart on page 59
 voir tableau des écartements d'aiguilles à la page 59

<p>91-049 616-03x2,4¹⁾  </p> <p>91-049 616-03x3,2¹⁾  </p>  <p>-944/01; -944/01-900/11</p>	<p>91-049 618-03¹⁾  </p>  <p>-944/01; -944/01-900/11</p>	

Nummernverzeichnis
Numerical index
Tableau des numéros
Indice numérico

No.	Seite Page Pages Página	No.	Seite Page Pages Página	No.	Seite Page Pages Página	No.	Seite Page Pages Página
11-039 174-15	18, 54	11-130 182-15	40, 42	11-314 082-15	30, 43	12-510 140-45	42
11-039 306-15	28	11-130 224-15	40, 48	11-314 220-15	18	12-510 141-45	36
11-084 357-15	34	11-130 230-15	28	11-314 280-15	19, 43	12-510 150-45	44
11-084 365-15	51	11-130 284-15	51	11-314 286-15	18	12-510 170-45	40
11-108 036-15	52	11-130 287-15	40	11-314 946-15	19, 51	12-510 190-45	42
11-108 045-25	50	11-133 538-15	31	11-317 083-15	54, 64	12-510 200-45	28, 29, 30
11-108 087-15	44, 52	11-173 174-15	19, 54	11-317 167-15	19	12-510 210-45	18, 40
11-108 093-15	28	11-173 174-35	35	11-317 950-15	19, 28, 29	12-510 240-45	23, 28
11-108 099-15	42	11-174 086-15	64	11-330 217-15	40	12-510 250-45	41
11-108 120-15	42	11-174 089-35	23, 51	11-330 952-15	24	12-510 280-45	26, 40
11-108 135-15	44	11-174 173-15	54, 64	11-335 172-15	27	12-510 300-45	27
11-108 171-15	28, 29, 31, 41, 42, 44, 50, 54	11-174 176-15	19	11-335 902-15	22, 27, 41	12-511 310-45	36
11-108 174-15	26, 41, 42, 50	11-174 229-15	34	11-341 901-15	41	12-518 170-45	44
11-108 177-15	42	11-178 091-15	18	11-341 902-15	22, 27, 29, 31, 41	12-518 190-45	42
11-108 180-15	30, 50	11-178 289-15	22	11-343 311-15	19	12-518 250-45	46
11-108 183-15	40, 44	11-210 044-15	29	11-460 157-15	34, 51, 52	12-540 050-55	30, 43
11-108 186-15	31	11-210 076-05	31	11-460 304-15	48	12-540 090-55	30, 34, 43
11-108 222-15	34, 43, 46	11-210 076-15	28, 44	11-470 310-15	51	12-540 130-55	22
11-108 225-15	22, 24, 26, 27, 28, 29, 31, 37, 40, 43, 46	11-210 081-15	24	11-470 358-15	36	12-540 150-55	19, 23, 43
11-108 228-15	42	11-210 084-15	44	11-670 001-45	31	12-540 190-55	43
11-108 231-15	18, 30, 36, 40, 42	11-210 107-15	51	11-705 169-05	18	12-542 120-45	19, 43
11-108 234-15	23	11-210 165-15	37, 44	12-005 175-15	24	12-560 270-45	34
11-108 240-15	36	11-210 168-15	28, 31	12-024 121-15	28, 51		
11-108 258-15	34	11-210 168-25	22	12-024 151-15	30, 40, 42, 50	<u>12-703 161-12</u>	30, 43
11-108 285-15	23, 28, 30, 31, 48	11-210 172-15	28, 30, 44	12-024 151-35	35	11-314 082-15	
11-108 291-15	18, 43	11-210 210-15	18, 28	12-024 171-15	24, 36	13-030 310-05	23
11-108 294-15	27	11-210 216-15	31	12-024 191-15	23, 31	13-030 341-05	35
11-108 297-15	40	11-210 258-15	23	12-305 084-15	24, 31, 43, 44	13-033 004-05	28
11-108 306-15	40	11-210 259-15	31	12-305 111-15	50	13-033 097-05	19
11-130 170-15	44	11-210 287-15	22	12-305 114-15	40, 42, 44	13-033 376-05	31
11-130 176-15	40	11-250 084-15	22	12-305 144-15	36, 42, 48	13-052 151-15	27
		11-250 165-35	51	12-305 174-15	28	13-052 187-15	31
		11-305 305-15	23	12-305 414-15	36	13-052 205-15	23

No.	Seite Page Pages Página	No.	Seite Page Pages Página	No.	Seite Page Pages Página	No.	Seite Page Pages Página
13-052 256-15	34, 48	14-018 643-01	22	16-437 010-05	15	71-37 00-0159	36
13-060 316-05	43			16-437 020-05	15	71-37 00-0223	51
13-060 400-05	31	<u>14-018 644-91</u>	22	16-437 030-05	13, 15	71-37 00-0226	42
13-072 337-15	40	14-018 643-01		16-437 040-05	13, 15	71-59 00-0256	48
13-250 901-05	31	14-680 070-15		16-437 050-05	13, 15	71-59 00-0257	48
14-012 562-01	28			16-437 060-05	13, 15	91-000 219-15	29, 44
		14-215 013-01	26	16-437 070-05	13	91-000 390-15	29, 44
<u>14-016 101-91</u>	40	14-215 022-01	18, 28, 29	16-437 080-05	13	91-000 529-15	29, 44
14-016 103-01		14-215 028-01	27, 31	16-437 090-05	13	91-000 928-15	29, 44
14-680 420-15		14-215 031-01	31, 40	16-437 100-05	13	91-002 065-05	19
		14-215 049-01	40	16-437 120-05	14	91-002 262-35	19
14-016 103-01	40	14-215 124-01	26	16-437 130-05	14	91-004 005-05	19
14-016 133-01	27	14-215 199-01	27	40-754 701-00	35	91-004 006-05	19, 35
14-016 150-01	22	14-215 304-01	31	70-22 28-0001	42	91-006 584-05	19
		14-515 009-01	40	70-36 20-0421	36	91-006 617-05	29
<u>14-016 151-91</u>	22, 29	14-515 012-01	40	71-11 00-0157	52	91-010 063-05	29
14-016 153-01		14-600 001-01	22	71-11 00-0228	51	91-010 064-15	29
14-680 060-15		14-650 214-05	27	71-12 00-0025	42	91-010 079-05	29, 35
		14-650 275-05	30	71-12 00-0415	52	91-010 115-05	19
14-016 153-01	22, 29	14-680 030-15	27, 40	71-12 00-0420	51	91-010 116-05	19
		14-680 050-15	27	71-12 00-0572	42	91-010 157-01	29
<u>14-016 171-91</u>	41	14-680 060-15	22, 29	71-14 00-0006	50	91-010 158-05	29
14-016 173-01		14-680 070-15	22, 41	71-16 00-0105	52		
14-680 070-15		14-680 420-15	40	71-16 00-0106	52	<u>91-010 159-91</u>	29
		15-110 002-05	30	71-16 00-0137	50	91-000 390-15	
14-016 173-01	41	15-120 112-05	30	71-16 00-0174	42	91-000 928-15	
14-017 120-01	28	15-120 702-05	29, 30	71-17 00-0131	42	91-010 158-05	
14-018 613-01	27, 40	15-125 135-05	31	71-21 00-0124	50	91-010 166-05	
		15-128 010-75	30	71-21 00-0144	42		
		15-128 030-75	30	71-37 00-0110	51	91-010 166-05	29, 44
<u>14-018 614-91</u>	27, 40	15-128 060-75	30	71-37 00-0132	42	91-010 178-05	29, 44
14-018 613-01		16-049 020-01	24	71-37 00-0133	42	91-010 180-05	19
14-680 030-15		16-049 040-11	48	71-37 00-0158	51	91-010 185-05	19

No.	Seite Page Pages Página	No.	Seite Page Pages Página	No.	Seite Page Pages Página	No.	Seite Page Pages Página
91-011 391-45	24	<u>91-032 800-91</u>	35	91-058 101-04	56, 61, 66	<u>91-069 335-92</u>	34
91-020 346-01	30	13-030 341-05		91-058 102-04	56, 61, 66	11-084 357-15	
91-020 490-15	23	91-032 802-45		91-058 110-04	56, 61, 66		
91-022 171-05	24			91-058 111-04	56, 61, 66	91-069 470-35	35
91-025 113-15	51	<u>91-032 801-91</u>	35	91-058 443-04	56, 61, 66	91-069 471-35	35
91-025 874-05	54	91-032 802-45		91-058 444-04	56, 61, 66	91-069 642-05	41
91-026 830-15	29	91-097 074-47		91-058 559-04	56, 61, 66	91-069 697-05	42, 46, 50
91-027 285-05	34	91-101 775-05		91-058 560-04	61, 66	91-069 921-05	18
91-027 286-15	34			91-058 561-04	56, 61, 66	91-069 955-05	43
91-027 288-15	34	91-032 802-45	35	91-058 562-04	56, 61, 66	91-069 992-35	35
91-027 289-15	34	91-032 803-45	35	91-058 650-04	56		
91-027 297-05	34	91-032 804-45	35	91-063 119-05	40	<u>91-084 102-91</u>	37
91-027 358-15	34	91-035 962-15	50, 52	91-066 381-15	18	91-084 115-05	
91-027 370-05	34	91-047 366-04	56, 60, 65	91-068 027-05	40	99-134 089-05	
		91-047 568-04	56, 60, 65			99-134 093-05	
<u>91-027 371-12</u>	34	91-047 569-04	56, 60, 65				
11-174 229-15		91-047 863-04	56, 60, 65	<u>91-069 079-92</u>	19	91-084 115-05	37
		91-047 864-04	56, 60, 65	11-317 950-15		91-084 119-15	37
		91-049 616-03	54, 57, 62, 68			91-084 125-15	37
91-029 007-91	35	91-049 618-03	54, 57, 62, 68	91-069 022-01	18		
91-029 358-05	36	91-053 424-05	51	91-069 132-35	24	<u>91-084 141-90</u>	37
91-029 359-15	36			91-069 135-05	24	11-108 225-15	
91-029 360-45	36			91-069 138-15	24	11-210 165-15	
91-029 364-45	36	<u>91-054 875-12</u>	54	91-069 172-15	34	<u>91-084 102-91</u>	
91-029 450-15	35	11-173 174-15				91-084 119-15	
91-029 480-91	35					91-084 125-15	
91-029 521-05	34					<u>91-118 215-91</u>	
91-029 692-45	34	91-054 876-15	54	<u>91-069 222-12</u>	24		
91-029 809-05	34	91-055 711-03	57, 62, 67	11-330 952-15		91-095 496-45	52
91-029 811-05	34	91-055 713-03	57, 62, 67			91-095 498-15	52
91-029 833-45	34	91-055 872-93	54, 57, 67	91-069 251-05	30	91-095 760-45	42
91-029 946-91	35	91-055 874-93	54, 57, 67	91-069 259-05	30	91-095 761-45	42
91-030 313-15	24	91-055 980-03	57, 62, 67	91-069 292-05	31	91-095 762-45	42

No.	Seite Page Pages Página	No.	Seite Page Pages Página	No.	Seite Page Pages Página	No.	Seite Page Pages Página
91-095 763-05	42	91-097 074-47	35	91-103 028-05	34	<u>91-118 196-93</u>	56, 60, 64
91-095 765-91	42			91-105 442-15	24	11-174 086-15	
		<u>91-099 426-91</u>	51	91-105 447-15	19	<u>91-118 196-12</u>	
<u>91-095 810-91</u>	42	11-084 365-15		91-118 098-35	22	91-118 197-05	
11-108 120-15		11-174 089-35				91-700 004-04	
70-22 28-0001		11-210 107-15		<u>91-118 099-91</u>	22	91-118 210-05	44
71-12 00-0025		11-250 165-35		11-250 084-15			
71-12 00-0572		12-024 121-15		12-640 130-55		<u>91-118 211-91</u>	44
71-16 00-0174		71-11 00-0228		14-600 001-01		11-108 087-15	
71-17 00-0131		71-12 00-0420		91-100 281-25		11-210 076-15	
71-21 00-0144		71-37 00-0158		91-118 098-35		12-305 084-15	
71-37 00-0226		91-053 424-05		91-118 681-05		<u>91-118 212-91</u>	
91-095 760-45		91-096 740-05		91-118 682-05		91-118 324-11	
91-095 761-45		<u>91-096 741-12</u>		91-118 683-05		91-118 674-15	
91-095 762-45		91-096 742-55		91-118 685-05		91-118 678-15	
91-095 763-45		91-096 743-05		91-118 931-05		91-118 679-15	
91-095 765-91		91-096 744-55		91-118 934-91			
91-095 811-91		91-096 745-05		91-118 935-05		<u>91-118 212-91</u>	44
91-118 416-15		91-099 427-45		91-118 937-01		91-118 210-05	
91-118 440-15		91-099 428-45		91-118 939-31		91-118 328-15	
		91-099 429-41		91-118 940-05		91-700 249-15	
				91-171 042-45		91-118 213-05	44
91-095 811-91	42			91-171 049-05			
91-096 740-05	51	91-099 427-45	51			<u>91-118 215-91</u>	37
		91-099 428-45	51			91-118 267-45	
		91-099 429-41	51	91-118 193-05	43	91-119 686-35	
<u>91-096 741-12</u>	51	91-099 811-05	42	<u>91-118 194-92</u>	40	91-700 335-15	
11-314 946-15		91-100 108-15	19	14-515 012-01			
		91-100 114-15	36			91-118 267-45	37
91-096 742-55	51	91-100 253-15	22	91-118 195-04	54, 64	91-118 271-05	41
91-096 743-05	51	91-100 281-25	22				
91-096 744-55	51	91-101 756-05	24	<u>91-118 196-12</u>	54, 64	<u>91-118 272-91</u>	41
91-096 745-05	51	91-101 758-15	24	11-174 173-15		11-335 902-15	
91-096 843-95	50	91-101 775-05	35			11-341 902-15	
91-097 059-55	51			91-118 197-05	54, 64		

No.	Seite Page Pages Página	No.	Seite Page Pages Página	No.	Seite Page Pages Página	No.	Seite Page Pages Página
<u>91-118 273-91</u>	41	<u>91-118 292-91</u>	30	91-118 320-01	44	<u>91-118 346-91</u>	40
11-335 902-15		15-120 702-05		91-118 324-11	44	<u>91-118 347-12</u>	
11-341 902-15		15-128 030-75		91-118 327-15	44	<u>91-118 348-91</u>	
<u>14-016 171-91</u>		91-118 293-15		91-118 328-15	44		
91-069 642-05		91-118 294-05				<u>91-118 347-12</u>	40
91-118 399-05		91-118 295-05		<u>91-118 329-91</u>	43	11-108 225-15	
		91-168 232-05		12-640 050-55			
<u>91-118 275-91</u>	22			12-640 090-55		<u>91-118 348-91</u>	40
11-335 902-15		91-118 293-15	30	<u>12-703 161-12</u>		12-610 170-45	
11-341 902-15		91-118 294-05	30	91-118 330-05		91-118 349-05	
		91-118 295-05	30	91-118 869-05		91-119 237-05	
<u>91-118 276-91</u>		91-118 296-05	28	91-118 870-05			
13-052 151-15		91-118 297-05	28	91-118 871-05		91-118 349-05	40
14-016 133-01		91-118 298-15	28	91-118 872-05		91-118 350-05	40
14-650 214-05		91-118 299-15	28				
91-118 277-05		91-118 301-45	43	91-118 330-05	43	<u>91-118 351-12</u>	40
91-118 719-15		91-118 304-15	44			11-130 287-15	
91-118 723-15				<u>91-118 334-12</u>	40		
91-118 725-45		<u>91-118 305-92</u>	44	11-330 217-15		<u>91-118 352-12</u>	40
		91-118 790-05				11-130 224-15	
91-118 277-05	27			91-118 335-15	40		
		91-118 306-15	44	91-118 336-05	40	91-118 354-15	41
<u>91-118 278-91</u>	27	91-118 308-05	44	91-118 337-91	40	91-118 356-05	41
11-335 902-15		91-118 309-15	44	91-118 339-91	40	91-118 358-15	40
11-341 902-15		91-118 314-91	44	91-118 340-91	40	91-118 362-11	42
		91-118 316-15	44			91-118 365-15	42
91-118 280-05	27	91-118 317-15	44	<u>91-118 343-12</u>	40	91-118 366-05	42
				11-130 287-15		91-118 367-15	46
<u>91-118 285-90</u>	50						
11-108 174-15		<u>91-118 318-91</u>	44	91-118 344-05	40	<u>91-118 369-91</u>	40
12-024 151-15		91-118 320-01				11-130 224-15	
71-14 00-0006		<u>91-118 414-91</u>		<u>91-118 345-12</u>	40		
91-170 637-15		<u>91-118 878-91</u>		11-130 287-15		91-118 371-05	41

No.	Seite Page Pages Página	No.	Seite Page Pages Página	No.	Seite Page Pages Página	No.	Seite Page Pages Página
91-118 372-11	43	<u>91-118 419-91</u>	44	91-118 439-15	42	<u>91-118 495-90</u>	48
91-118 376-11	43	91-118 320-01		91-118 440-15	42	11-108 285-15	
91-118 378-05	41	<u>91-118 414-91</u>				11-130 224-15	
91-118 379-05	43	<u>91-118 877-91</u>				11-460 304-15	
91-118 380-15	43					12-305 144-15	
91-118 384-01	43	<u>91-118 421-91</u>	40	<u>91-118 482-91</u>	23	16-049 040-11	
91-118 388-01	43	12-610 280-45		13-030 310-05		71-59 00-0257	
91-118 392-15	43	<u>14-018 614-91</u>		91-118 483-15		<u>91-118 905-12</u>	
91-118 393-05	43	<u>91-118 726-12</u>		91-118 909-05		91-118 953-15	
91-118 394-01	43					91-118 955-15	
91-118 399-05	41	<u>91-118 425-91</u>	43			91-118 956-15	
91-118 403-15	43	12-640 090-55		91-118 483-15	23	<u>91-171 542-91</u>	
		12-640 150-55					
<u>91-118 404-91</u>	41	91-118 384-01					
11-108 171-15		91-118 392-15		<u>91-118 485-91</u>	41		
11-341 901-15		91-118 539-05		11-108 174-15		<u>91-118 497-90</u>	48
91-118 371-05				11-341 901-15		11-108 285-15	
91-118 405-01		91-118 430-35	19	91-118 356-05		11-130 224-15	
				91-118 486-05		11-460 304-15	
91-118 405-01	41	<u>91-118 434-91</u>	28			12-305 114-15	
91-118 408-15	40	12-610 200-45				16-049 040-11	
91-118 411-05	40	14-017 120-01				71-59 00-0256	
91-118 412-05	40	14-215 022-01		91-118 486-05	41	<u>91-118 905-12</u>	
		91-118 762-05				91-118 953-15	
		91-118 796-05		<u>91-118 487-91</u>	28	91-118 955-15	
<u>91-118 414-91</u>	44			13-033 004-05		91-118 956-15	
91-000 390-15		<u>91-118 435-91</u>	43	91-118 488-15		<u>91-171 542-91</u>	
91-000 928-15		12-640 150-55		91-118 711-05		91-118 501-45	24
91-010 166-05		91-118 372-11		91-118 769-05		91-118 502-45	31
91-118 415-05		91-118 436-11					
						<u>91-118 504-92</u>	18
91-118 415-05	44	91-118 436-11	43			91-700 689-15	
91-118 416-15	42	91-118 438-15	42	91-118 488-15	28		

No.	Seite Page Pages Página	No.	Seite Page Pages Página	No.	Seite Page Pages Página	No.	Seite Page Pages Página
<u>91-118 505-91</u>	18	91-118 539-05	19, 43	<u>91-118 568-91</u>	23	91-118 586-01	43
12-610 210-45		91-118 542-05	19	11-108 234-15		91-118 589-05	18
14-215 022-01		91-118 543-45	23	91-020 490-15		<u>91-118 590-91</u>	18
91-118 518-05		91-118 544-15	23	91-118 543-45		11-178 091-15	
<u>91-118 561-01</u>		<u>91-118 549-91</u>	35	91-118 544-15		11-705 169-05	
<u>91-119 006-01</u>		91-004 006-05		91-118 569-05	22	91-066 381-15	
91-119 008-05		91-069 470-35		<u>91-118 570-92</u>	22	91-069 921-05	
91-119 009-05		91-069 471-35		91-700 689-15		<u>91-118 504-92</u>	
91-119 010-04		91-069 992-35		91-118 577-11	19	91-118 589-05	
<u>91-119 013-92</u>		91-169 029-05		91-118 580-05	31	91-118 591-41	
91-168 039-05		91-118 553-05	19	91-118 581-05	31	91-118 594-15	
91-168 046-15		<u>91-118 554-91</u>	35	<u>91-118 583-90</u>	50	91-119 015-15	
91-168 047-14		11-173 174-35		91-069 697-05		91-173 029-05	
91-118 509-05	31	12-024 151-35		<u>91-118 584-91</u>	50	91-118 591-41	18
91-118 518-05	18	<u>91-118 549-91</u>		11-108 045-25		91-118 594-15	18
91-118 520-05	18	91-118 555-35	35	11-108 171-15		91-118 596-05	18
91-118 521-15	18	91-118 556-35	35	11-108 180-15		91-118 597-05	31
91-118 524-15	28	91-118 557-35	35	12-305 111-15		91-118 598-05	31
91-118 526-05	19	<u>91-118 561-01</u>	18	71-16 00-0137		91-118 599-05	31
91-118 527-01	19, 57	91-069 022-01		71-21 00-0124		91-118 600-91	26
<u>91-118 530-12</u>	19	91-118 562-05		91-035 962-15		91-118 603-91	26
91-700 510-15		91-118 563-05		91-096 843-95		91-118 606-15	31
91-118 531-15	19	91-118 562-05	18	91-118 585-15		91-118 611-01	23
91-118 535-15	19	91-118 563-05	18	91-119 319-91		91-118 612-05	27
91-118 536-11	19	91-118 562-05	18	91-118 585-15	50	<u>91-118 620-91</u>	31
<u>91-118 538-91</u>	19	91-118 563-05	18			11-210 076-05	
12-640 150-55						14-215 304-01	
12-642 120-45						91-118 644-05	
91-118 536-11						<u>91-118 645-92</u>	
91-118 539-05						91-118 647-05	
91-118 542-05							

No.	Seite Page Pages Página	No.	Seite Page Pages Página	No.	Seite Page Pages Página	No.	Seite Page Pages Página
<u>91-118 621-92</u>	31	<u>91-118 632-91</u>	24	<u>91-118 645-92</u>	31	91-118 695-45	34
11-108 225-15		12-005 175-15		11-341 902-15		91-118 696-45	34
91-700 510-15		16-049 020-01				91-118 697-45	23
		91-022 171-05		91-118 647-05	31	91-118 703-11	28
		91-118 850-01		91-118 651-05	31	91-118 706-15	28
<u>91-118 622-91</u>	31	91-118 634-15	31	<u>91-118 652-92</u>	31	<u>91-118 707-12</u>	28
12-305 084-15				11-108 225-15		91-700 510-15	
13-250 901-05				91-700 510-15			
14-215 028-01						91-118 708-15	28
14-215 031-01		<u>91-118 637-91</u>	31	91-118 653-05	31	91-118 709-15	28
91-118 598-05		12-305 084-15				91-118 711-05	28
91-118 599-05		13-250 901-05		<u>91-118 654-11</u>	31	91-118 715-01	27
<u>91-118 620-91</u>		14-215 028-01		13-033 376-05			
<u>91-118 638-21</u>		14-215 031-01				<u>91-118 715-92</u>	27
91-118 642-05		91-118 598-05				14-680 050-15	
91-118 643-05		91-118 599-05		<u>91-118 657-91</u>	24	91-118 715-01	
<u>91-118 652-92</u>		<u>91-118 620-91</u>		11-210 081-15			
91-118 653-05		<u>91-118 621-92</u>		12-305 084-15		<u>91-118 716-91</u>	29
		<u>91-118 638-91</u>		91-069 138-15		91-010 063-05	
91-118 625-31	24	91-118 642-05		91-118 665-91		91-010 064-15	
		91-118 643-05				91-118 717-45	
		91-118 653-05		91-118 665-91	24		
				91-118 674-15	44	91-118 717-45	29
<u>91-118 628-91</u>	24	<u>91-118 638-91</u>	31	91-118 678-15	44	91-118 719-15	27
<u>91-118 630-92</u>		11-108 186-15		91-118 679-15	44	91-118 720-05	27
<u>91-118 632-91</u>		11-210 259-15		91-118 681-05	22		
		13-052 187-15		91-118 682-05	22		
<u>91-118 629-92</u>	24	<u>91-118 654-11</u>		91-118 683-05	22		
11-108 225-15				91-118 685-05	22	<u>91-118 721-91</u>	27
		91-118 642-05	31			12-610 300-45	
<u>91-118 630-92</u>	24	91-118 643-05	31	<u>91-118 694-91</u>	29	<u>91-118 715-92</u>	
11-108 225-15		91-118 644-05	31	11-341 902-15		<u>91-118 722-12</u>	

No.	Seite Page Pages Página	No.	Seite Page Pages Página	No.	Seite Page Pages Página	No.	Seite Page Pages Página
<u>91-118 722-12</u>	27	<u>91-118 753-91</u>	29	<u>91-118 764-01</u>	29	<u>91-118 847-91</u>	30
91-700 689-12		11-210 044-15		91-006 617-05		14-650 275-05	
		12-610 200-45		91-118 765-05		15-120 112-05	
		<u>14-016 159-91</u>		91-118 766-05		15-128 010-75	
91-118 723-15	27	14-215 022-01				15-128 060-75	
91-118 725-45	27	<u>91-118 694-91</u>		91-118 765-05	29	91-069 251-05	
		91-118 756-15		91-118 766-05	29	91-069 259-05	
		91-118 757-05		91-118 769-05	28	91-118 848-05	
		91-118 758-15				91-169 355-05	
<u>91-118 726-12</u>	40	<u>91-118 759-92</u>		<u>91-118 782-92</u>	28	91-169 974-05	
91-700 689-15				91-118 790-05			
		91-118 756-15	29			91-118 848-05	30
		91-118 757-05	28, 29				
		91-118 758-15	28, 29			<u>91-118 849-91</u>	23
91-118 727-05	27			<u>91-118 785-91</u>	28	13-030 310-05	
91-118 737-05	31	<u>91-118 759-92</u>	29	14-012 562-01		13-052 205-15	
		11-108 225-15		91-118 786-05		91-118 851-15	
		11-317 950-15		<u>91-118 792-90</u>		91-118 854-05	
<u>91-118 738-91</u>	31	<u>91-118 760-91</u>	28				
91-118 580-05		12-610 200-45		91-118 786-05	28	91-118 850-01	24
91-118 581-05		14-215 022-01		91-118 787-15	28	91-118 851-15	23
91-118 597-05		<u>91-118 434-91</u>		91-119 788-45	28		
91-118 737-05		91-118 757-05		91-118 790-05	28, 44		
91-118 739-95		91-118 758-15		91-118 791-05	29	<u>91-118 852-91</u>	30
91-118 740-05		91-118 761-15				15-110 002-05	
		<u>91-118 763-92</u>		<u>91-118 792-90</u>	28	15-128 010-75	
				11-130 230-15		15-128 030-75	
		91-118 761-15	28			91-069 259-05	
91-118 739-95	31	91-118 762-05	28	91-118 796-05	28	91-118 853-15	
91-118 740-05	31			91-118 835-34	29	91-118 856-05	
91-118 741-02	29	<u>91-118 763-92</u>	28	91-118 840-34	29	91-168 363-15	
91-118 743-05	29, 44	11-108 225-15		91-118 844-34	43		
91-118 748-05	29, 44	11-317 950-15		91-118 845-34	43	91-118 853-15	30

No.	Seite Page Pages Página	No.	Seite Page Pages Página	No.	Seite Page Pages Página	No.	Seite Page Pages Página
91-118 854-05	23	<u>91-118 876-91</u>	29	91-118 883-05	26	<u>91-118 901-12</u>	27
91-118 856-05	30	91-010 157-01		91-118 884-45	26	11-108 294-15	
91-118 857-05	23	<u>91-010 159-91</u>				91-700 510-15	
91-118 858-15	23	<u>91-118 878-91</u>		<u>91-118 886-92</u>	26		
91-118 859-05	30			11-108 225-15		<u>91-118 903-92</u>	27
91-118 861-45	18	<u>91-118 877-91</u>	29, 44	91-700 689-15		11-108 225-15	
<u>91-118 863-12</u>	30	91-000 219-15					
11-108 180-15		91-000 529-15		91-118 887-05	26	<u>91-118 905-12</u>	48
12-024 151-15		91-010 178-05		91-118 888-05	26	13-052 256-15	
91-118 866-15	30	91-118 748-05					
		91-119 377-05		<u>91-118 889-12</u>	26	91-118 909-05	23
<u>91-118 867-91</u>	30			91-700 689-15		91-118 910-05	34
12-640 050-55		<u>91-118 878-91</u>	29, 44				
12-640 090-55		91-000 219-15		<u>91-118 893-92</u>	26		
<u>12-703 161-12</u>		91-000 529-15		91-700 689-15		<u>91-118 926-91</u>	43
91-118 868-05		91-010 178-05				12-640 090-55	
91-118 869 05		91-118 743-05		91-118 894-05	26	91-118 394-01	
91-118 870-05		91-119 377-05				91-118 403-15	
91-118 871-05				<u>91-118 895-91</u>	27		
91-118 872-05		<u>91-118 880-91</u>	26	<u>14-018 614-91</u>			
		14-215 013-01		14-215 028-01		<u>91-118 927-91</u>	43
91-118 868-05	30	91-118 881-15		14-215 199-01		12-640 190-55	
91-118 869-05	30, 43	<u>91-118 882-92</u>		91-118 612-05		91-118 376-11	
91-118 870-05	30, 43	91-118 883-05		91-118 896-05		91-118 379-05	
91-118 871-05	30, 43	91-118 884-45		91-118 898-05			
91-118 872-05	30, 43	<u>91-118 886-92</u>		<u>91-118 900-92</u>		91-118 931-05	22
91-118 873-05	28	91-118 887-05		<u>91-118 901-12</u>		91-118 934-91	22
91-118 874-05	28	<u>91-118 889-12</u>		<u>91-118 903-92</u>		91-118 935-05	22
		91-118 881-15	26	91-118 896-05	27	91-118 937-01	22
<u>91-118 875-91</u>	29	<u>91-118 882-92</u>	26	91-118 898-05	27	91-118 938-31	22
91-010 157-01		11-108 225-15		<u>91-118 900-92</u>	27	91-118 940-05	22
<u>91-010 159-91</u>		91-700 689-15		91-700 689-15		91-118 941-15	40
<u>91-118 877-91</u>						91-118 942-15	40

No.	Seite Page Pages Página	No.	Seite Page Pages Página	No.	Seite Page Pages Página	No.	Seite Page Pages Página
<u>91-118 944-91</u>	19	<u>91-119 006-01</u>	18	91-119 093-31	19	<u>91-119 702-91</u>	22
11-317 167-15		91-069 022-01		91-119 098-45	18	11-108 225-15	
13-033 097-05		91-119 007-05					
91-002 065-05		91-119 049-05		<u>91-119 099-91</u>	18	<u>91-119 704-91</u>	22
91-002 262-35		91-168 037-01		91-119 098-45		<u>14-016 151-91</u>	
91-004 005-05				91-119 686-35		<u>91-119 705-12</u>	
91-004 006-05		91-119 007-05	18	91-700 335-15			
91-006 584-05		91-119 008-05	18			<u>91-119 705-12</u>	22
91-010 115-05		91-119 009-05	18	91-119 119-05	19	11-335 902-15	
91-010 116-05		91-119 010-04	18	91-119 237-05	40	11-341 902-15	
91-010 180-05							
91-010 185-05		<u>91-119 013-92</u>	18	<u>91-119 249-92</u>	46, 50		
91-105 447-15		11-039 174-15		91-700 510-15		<u>91-119 744-93</u>	54, 56 60, 64
91-119 023-15						91-118 195-04	
91-119 024-15		91-119 015-15	18	91-119 309-04	54, 64	<u>91-118 196-12</u>	
91-119 065-31		91-119 016-05	19	91-119 319-91	50	91-118 197-05	
91-119 093-31		91-119 018-01	54, 57	91-119 347-05	19	91-700 868-15	
91-119 119-05		91-119 023-15	19	91-119 348-05	19		
91-119 347-05		91-119 024-15	19	91-119 377-05	29, 44	<u>91-119 746-93</u>	54, 56 60, 64
91-119 348-05		91-119 025-35	19			11-317 083-15	
91-168 194-91		91-119 026-35	35			<u>91-118 196-12</u>	
91-700 366-15		91-119 027-35	19	<u>91-119 489-90</u>	51	91-118 197-05	
91-701 522-35		91-119 039-92	23	11-130 284-15		91-119 309-04	
		91-119 049-05	18	11-460 157-15			
		91-119 065-31	19	11-470 310-15		91-129 029-45	36
				71-37 00-0110			
		<u>91-119 081-92</u>	27	71-37 00-0223		<u>91-129 100-91</u>	34
		91-700 510-15		91-025 113-15		12-660 270-45	
91-118 948-91	42	91-700 680-15		91-097 059-55		91-029 809-05	
91-118 953-15	48	99-133 109-05		<u>91-099 426-91</u>		91-129 101-41	
91-118 955-15	48						
91-118 956-15	48	91-119 084-05	26	91-119 686-35	18, 37	91-129 101-41	34
91-119 004-05	19	91-119 085-05	26				

No.	Seite Page Pages Página	No.	Seite Page Pages Página	No.	Seite Page Pages Página	No.	Seite Page Pages Página
91-129 138-91	35	<u>91-129 652-90</u>	36	<u>91-129 641-92</u>		91-169 582-05	40
91-129 140-15	43	11-470 358-15		91-129 644-05		91-169 974-05	30
91-129 637-45	36	70-36 20-0421		91-129 645-45		91-170 637-15	42, 50
		91-129 029-45		<u>91-129 646-92</u>			
		91-129 637-45		91-129 649-45			
<u>91-129 641-92</u>	36	<u>91-129 641-92</u>		99-115 034-15		<u>91-170 913-92</u>	22
11-108 240-15		91-129 644-05				11-335 902-15	
12-024 171-15		91-129 645-45		91-129 968-45	36	11-341 902-15	
		<u>91-129 646-92</u>		91-129 969-45	36		
91-129 644-05	36	91-129 649-45		91-129 970-91	36		
91-129 645-45	36	99-115 034-15		91-168 037-01	18	91-171 042-45	22
		99-115 037-45		91-168 039-05	18	91-171 049-05	22
				91-168 041-05	18		
<u>91-129 646-92</u>	36	<u>91-129 654-90</u>	36	91-168 045-15	18		
11-108 240-15		12-305 414-15		91-168 047-14	18		
12-024 171-15		12-611 310-45					
		70-36 20-0421		<u>91-168 054-92</u>	22	<u>91-171 412-91</u>	34
91-129 649-45	36	91-129 637-45		91-700 689-15		13-052 256-15	
		<u>91-129 641-92</u>				91-027 289-15	
		91-129 644-05		<u>91-168 055-91</u>	22	91-027 370-05	
		91-129 645-45		14-016 150-01		<u>91-027 371-12</u>	
<u>91-129 651-90</u>	36	<u>91-129 646-92</u>		<u>91-168 054-92</u>		91-029 692-45	
11-108 231-15		91-129 649-45				<u>91-069 335-92</u>	
12-024 171-15		99-115 034-15		91-168 061-15	18	91-171 413-15	
12-305 144-15		99-115 037-45		91-168 194-91	19	<u>91-171 542-91</u>	
12-510 141-45				91-168 232-05	30		
91-029 358-05				91-168 363-15	30	91-171 413-15	34
91-029 359-15		<u>91-129 656-90</u>	36	91-168 480-15	22		
91-029 360-45		12-305 414-15		91-168 926-05	42	<u>91-171 542-91</u>	34, 48
91-029 364-45		12-611 310-45		91-168 935-91	46	91-171 543-05	
91-100 114-15		70-36 20-0421		91-169 029-05	35	91-171 544-15	
91-129 968-45		71-37 00-0159		91-169 352-05	23		
91-129 969-45		91-129 637-45		91-169 355-05	30	91-171 543-05	34, 48
91-129 970-91							

No.	Seite Page Pages Página	No.	Seite Page Pages Página	No.	Seite Page Pages Página	No.	Seite Page Pages Página
91-171 544-15	34, 48						
91-173 029-05	18						
91-700 017-15	19						
91-700 082-15	19						
91-700 173-15	26						
91-700 249-15	44						
91-700 324-15	54						
91-700 335-15	18, 23, 37						
91-700 366-15	19						
91-700 412-35	19						
91-700 510-15	19, 22, 27, 28, 31, 46, 50						
91-700 680-15	22, 27, 41						
91-700 689-15	18, 22, 26, 27, 40						
91-700 785-15	19						
91-700 868-15	54, 64						
91-700 965-15	31						
91-701 370-15	24						
91-701 515-35	35						
91-701 522-35	19						
91-710 004-04	64						
97-30 117-345	34						
99-115 034-15	36						
99-115 037-45	36						
99-133 109-05	27						
99-133 283-15	26						
99-133 893-05	27						
<u>99-133 899-01</u>	27						
99-133 900-05							
99-133 900-05	27						
99-134 089-05	37						
99-134 093-05	37						